



Narzędzia skrawające

Katalog | wydanie 21

Fabryka Narzędzi FANAR S.A.

Fabryka Narzędzi FANAR S.A.

jest wiodącym producentem narzędzi skrawających do obróbki metali

Od wielu lat stawiamy na nowoczesne rozwiązania, wysoką jakość i ciągły rozwój. Posiadamy wiedzę i doświadczenie, które wsparte **najnowszą technologię i nowoczesnym parkiem maszynowym** pozwalają nam zaoferować nowoczesne produkty, spełniające najwyższe wymagania jakościowe. Jesteśmy cenionym dostawcą w kraju, jak i za granicą. Współpracujemy z największymi światowymi producentami z branż: samochodowej, lotniczej, medycznej, AGD i innych.

Szeroka oferta produktowa wsparta serwisem, doradztwem technicznym oraz nowymi rozwiązaniami informatycznymi w obsłudze klienta zapewniają wysoki poziom zadowolenia klientów.



Jesteśmy producentem o zasięgu globalnym

Nasze narzędzia są dystrybuowane do **40 krajów**. Coraz bardziej rozpoznawalna marka producenta o najwyższej jakości pozwala na dalszą ekspansję międzynarodową. Poszukując **narzędzi skrawających najwyższej jakości** skorzystaj z naszej globalnej sieci dystrybucji. Lista oficjalnych dystrybutorów dostępna na stronie www.fanar.pl.

INFORMACJE TECHNICZNE

Grupy zastosowania narzędzi wysokowydajnych i ich przeznaczenie:

Linia MASTER Gwintowniki **MASTER TAP**, frezy **MASTER MILL** oraz wiertła **MASTER DRILL** charakteryzują się najwyższą wydajnością. Są to narzędzia produkowane z wykorzystaniem najnowocześniejszych technologii oraz materiałów. Cechują się możliwością zastosowania w szerokim spektrum materiałów.

Linia X Gwintowniki **BOOX**, frezy **X-MILL** oraz wiertła **X-DRILL**, zawierają największą liczbę wariantów narzędzi umożliwiającą dobór do niemal każdej aplikacji. Multifunkcyjne narzędzia do stosowania zarówno na maszynach konwencjonalnych obrabiarkach jak i nowoczesnych maszynach CNC.

800 Do stali konstrukcyjnych węglowych, automatowych i niskostopowych, o wytrzymałości Rm ≤ 800 MPa.

FAN-200 Do stali narzędziowych i trudnoobrabialnych o wytrzymałości 800 MPa ≤ Rm ≤ 1200 MPa oraz ulepszanych cieplnie do 38 HRC.

1400-HT Do obróbki twardych i ścierających materiałów takich jak stale o wytrzymałości Rm od 1200 do 1400 MPa oraz aluminium z wysoką zawartością krzemu.

INOX Do stali wysokostopowych, nierdzewnych i kwasoodpornych o wytrzymałości Rm ≤ 1000 MPa.

GG Do obróbki żeliwa szarego i sferoidalnego.

GAL Do odlewniczych stopów aluminium o zawartości Si max 12%.

AL Do aluminium i metali nieżelaznych.

HRC Do materiałów w stanie zahartowanym. Liczba obok symbolu oznacza maksymalną twardość materiału obrabianego w skali HRC.

S-NC Do gwintowania synchronicznego na obrabiarkach CNC z funkcją „rigid tapping” szerokiej gamy materiałów z dużymi prędkościami skrawania.

Ms Do mosiądzu i brązu krótkowiórowego.

WGN Wygniatki do obróbki materiałów o ograniczonej ciągliwości.



Więcej informacji na naszej stronie WWW.FANAR.PL

Wyżarzana A
Ulepszana cieplnie QT
Hartowana i odpuszczana HT
Utwardzana wydzieleniowo PH

	Oznaczenie	Cena	Dostępność	Prędkość skrawania Vc (m/min)	Typ otworu
W katalogu	●	w cenniku	z magazynu	10-15	Narzędzie zalecane
	●	w cenniku	na zapytanie		
	-	brak	brak możliwości wykonania	10-15	Narzędzie możliwe do zastosowania
Poza katalogiem	indeks standardowy indeks specjalny	na zapytanie	na zapytanie	👉	Obróbka ręczna

Rodzaj powłoki

HL TiAIN + WC/C	TC TiN + TiCN	TB TiB ₂
TN2 TiAIN + TiN	AT AITiN	TS TiAISiN

Wykonanie - rowki

C		Rowki proste
B		Rowki proste ze skośną powierzchnią natarcia
R		Rowki śrubowe prawe
L		Rowki śrubowe lewe

Chłodziwo





























E Emulsja **O** Olej **P** Pasta do gwintowania **MQL** Smarowanie minimalną ilością chłodziwa

Podane w tabeli prędkości skrawania mają charakter orientacyjny. Rzeczywiste prędkości należy dobrać doświadczalnie.

		Rm	HB	HRC	kc	PRZYKŁAD MATERIAŁU	NR MATERIAŁU	RODZAJ WIÓRA				
Stal	P	P1	Stal automatowa	A	750	220	2500	11SMnPb30 / 10SPb20 / 35S20 / 11SMn37	1.0718 / 1.0722 / 1.0726 / 1.0736	krótki	P1	
		P2	C ≤ 0,55 % wyżarzona	A	650	190	-	2500	S235JR / S275JR / C22 / C45	1.0038 / 1.0044 / 1.0402 / 1.0503	długi	P2
		P3	C > 0,55 % wyżarzona	A	650	190	-	2500	C55 / C60 / C60E	1.0535 / 1.0601 / 1.1221	długi	P3
		P4	C ≤ 0,55 % ulepszana cieplnie	QT	700	210	-	2500	C25E / C53G / G18Mo5 / 16Mo5	1.1158 / 1.1213 / 1.5422 / 1.5423	długi	P4
		P5	C > 0,55 % ulepszana cieplnie	QT	1000	300	32	2600	C55 / C55E / C60E	1.0535 / 1.1203 / 1.1221	długi	P5
		P6	Stal niskostopowa	A	600	175	-	2300	36Mn5 / 107CrV3 / 100Cr6 / 20NiCrMo2-2 / 41Cr4	1.1167 / 1.2210 / 1.3505 / 1.6523 / 1.7035	długi	P6
		P7		QT	1000	300	32	2600	34Cr4 / 25CrMo4 / 42CrMo4 / Weldox 700 / Weldox 900	1.7033 / 1.7218 / 1.7225	długi	P7
		P8		QT	1200	380	41	3000	36NiCr6 / 34CrNiMo6 / 55Cr3 / 51CrV4	1.5710 / 1.6582 / 1.7176 / 1.8159	długi	P8
		P9		QT	1400	420	45	3600	55Si7 / 60SiCr7 / 55NiCrMoV6 / 40CrMoV13-9	1.0904 / 1.0961 / 1.2713 / 1.8523	długi	P9
		P10		A	700	210	-	2500	X210Cr12 / X100CrMoV5-1 / HS6-5-2-5 / HS6-5-2	1.2080 / 1.2363 / 1.3243 / 1.3343	średni	P10
		P11	Stal wysokostopowa i wysokostopowa stal narzędziowa	A	1000	300	32	2600	HS6-5-2-5 / HS18-1-2-5 / HS 10-2-5-8 / HS 6-5-3-8	1.3243 / 1.3255 / 1.3253 / 1.3294	średni	P11
		P12		HT	1400	420	45	3600	X30WCrV9-3	1.2581	średni	P12
		P13	Stal nierdzewna	A	700	210	-	3200	X6Cr13 / X12Cr13 / X14CrMoS17 / X6CrMo17-1	1.4000 / 1.4006 / 1.4104 / 1.4113	długi	P13
		P14		QT	1100	330	34	3200	X12Cr13 / GX20Cr14 / X19CrNi17-2 / X45CrSi9-3-1	1.4006 / 1.4027 / 1.4057 / 1.4718	długi	P14
Stal nierdzewna	M	M1	Austenityczna		700	210	-	3200	X5CrNi18-10 / X5CrNiMo17-12-2 / X2CrNiMo18-14-3 / X12NiCrSi36-16	1.4301 / 1.4401 / 1.4435 / 1.4864	długi	M1
		M2	Austenityczna	PH	1000	300	32	3200	X9CrNi18-8 / X53CrMnNiN21-9	1.4310 / 1.4871	długi	M2
		M3	Duplex		800	240	23	4000	X2CrNiNIN23-4 / X2CrNiMoN17-13-3 / X2CrNiMoN22-5-3 / X2CrNiMoCuN25-6-3	1.4362 / 1.4429 / 1.4462 / 1.4507	długi	M3
Żeliwo	K	K1	Żeliwo szare (GJL)		400	120	-	1600	EN-GJL-100 / EN-GJL-200 / EN-GJL-300 / EN-GJL-400	0.6010 / 0.6020 / 0.6030 / 0.6040	bardzo krótki	K1
		K2	Żeliwo wermikularne (GJV) CGI		550	160	-	2500	EN-GJV-300 / EN-GJV-400 / EN-GJV-500 / EN-GJV-550	-	krótki/średni	K2
		K3	Żeliwo ciągliwe(GJMW / GJMB)		500	150	-	2700	EN-GJMW-300-26 / EN-GJMB-350-10 / EN-GJMB-450-6	0.8035 / 0.8135 / 0.8145	krótki/średni	K3
		K4	Żeliwo ciągliwe (GJMB)		800	240	-	2700	EN-GJMB-550-4 / EN-GJMB-700-2 / EN-GJMB-800-1	0.8155 / 0.8170 / 0.8180	krótki/średni	K4
		K5	Żeliwo sferoidalne (GJS)		700	210	-	2400	EN-GJS-400-15 / EN-GJS-500-7 / EN-GJS-700-2	0.7040 / 0.7050 / 0.7070	krótki/średni	K5
		K6	Żeliwo sferoidalne (GJS) ADI		1400	420	45	3600	EN-GJS-800-8 / EN-GJS-1200-2 / EN-GJS-1400-1	-	krótki/średni	K6
Metale nieżelazne	N	N1	Stopy aluminium do obróbki plastycznej	PH	200	-	-	680	ENAW-AI99.5 / ENAW-AISi1MgMn (PA4) / ENAW-AIMg0.7Si (PA38) / ENAW-AIMg3 (PA11)	3.0255 / 3.2315 / 3.3206 / 3.3535	long	N1
		N2			500	152	-	680	ENAW-AICu6BiPb / ENAW-AICu4MgSi(A) (PA6) / ENAW-AIZn5.5MgCu (Pa9) / ENAW-AIMg4.5Mn0.7 (PA13)	3.1655 / 3.1325 / 3.4365 / 3.3547	long	N2
		N3	Stopy aluminium odlewnicze		250	75	-	680	ENAC-AISi12 / ENAC-AISi12(Fe) / ENAC-AISi12(Cu) / ENAC-AIMg5	3.2581 / 3.2582 / 3.2583 / 3.3561	krótki/średni	N3
		N4		PH	300	90	-	680	ENAC-AICu4MgTi / ENAC-AISi7Mg0.3 / ENAC-AISi9Mg / ENAC-AISi10Mg(a)	3.1371 / 3.2371 / 3.2373 / 3.2381	krótki/średni	N4
		N5			450	130	-	680	ENAC-AISi17Cu4Mg	-	krótki	N5
		N6	Stopy magnezu		250	70	-	750	EN-MAMgMn1 / EN-MCMgRE3Zn2Zr / EN-MCMgRE2Ag2Zr / EN-MCMgAl4Si	3.5101 / 3.5103 / 3.3506 / 3.5470	krótki	N6
		N7			350	100	-	1100	Cu-OF / Cu-DHP / CuZn35Mn2Al1Fe1-C / CuAl10Ni5Fe4	2.0040 / 2.0090 / 2.0592 / 2.0966	bardzo długi	N7
		N8	Miedź i jej stopy		600	180	-	1900	CuZn37 (M63) / CuAl10Ni5Fe4 / CuSn8P	2.0321 / 2.0966 / 2.1030	długi	N8
		N9			400	120	-	1900	CuZn40Pb2 (M58)(MO58) / CuSn7Zn4Pb7-C / CuSn5Zn5Pb5-C / CuSn10Pb10-C	2.0402 / 2.1090 / 2.1096 / 2.1176	krótki	N9
		N10			1000	300	32	1400	AMPCCO 8 / AMPCCO 21 / AMPCCO M4	-	długi	N10
Stopy żaroodporne i stopy tytanu	S	S1	Na bazie Fe	A	675	200	-	4000	Incoloy 909 / Multimet 155 / X10NiCrAlTi3220 (Incoloy 800) / X40CoCrNi2020	1.4876 / 1.4977	długi	S1
		S2		PH	950	280	29	4000	Incoloy A-286 / Unitemp 212	-	długi	S2
		S3		A	850	250	25	4000	Incoloy 864 / Nimocast 713	-	długi	S3
		S4	Na bazie Ni/Co	PH	1200	350	38	4000	Inconel 718 / Nimonic 80A	-	długi	S4
		S5		C	1100	320	34	4000	GMR 235* / Jessop G81*	-	długi	S5
		S6	Czysty tytan		675	200	-	4000	Ti 99.8 / TiCu2	3.7025 / 3.7124	bardzo długi	S6
		S7	Stopy tytanu		1250	375	40	4000	Ti-6Al-4V / Ti-6Al-2Mo-2Cr / Ti-6Al-6Mo-4Zr-2Sn	3.7165	krótki/średni	S7
		S8	Stopy α- i β		1400	410	44	4000	Ti-10V-2Fe-3Al / Ti-13V-11Cr-3Al	-	krótki/średni	S8
Materiały twarde	H	H1	Stal hartowana	HT			50	4100	Weldox 1100 / Weldox 1300 / Hardox 500	-	krótki	H1
		H2		HT			55	4700	Hardox 550 / Hardox 600 / Armax 600 T	-	krótki	H2
		H3		HT			60	5000	Hardox Extreme	-	krótki	H3
		H4	Żeliwo utwardzone i hartowane	HT			55	4700	GX260NiCr42 / GX330NiCr42 / GX300CrMoNi15-2-1	0.9620 / 0.9625 / 0.9640	krótki	H4

GRUPA MATERIAŁOWA

GRUPA MATERIAŁOWA





















MASTER TAP						800 X			800			FAN-1200		Nazwa
B-HL	B-IKR-HL	C-R45-HL	C-R45-IK-HL	E-R45-HL	E-R45-IK-HL	C-TN2	B-TN2	C-R40-TN2	C	B	C-R40	B-TS	C-R40-TS	
														
17 / 18 40 / 41 63 67	17 / 18 40 / 41	17 / 18 40 / 41 63 67	17 / 18 40 / 41	17 / 18 40 / 41	17 / 18 40 / 41	19 / 20 42 / 43 / 44	19 / 20 / 23 42 / 43 / 44 64 68 71	21 / 22 / 23 42 / 43 / 44 64 68 71	24 / 25 45 / 46 / 47	24 / 25 / 28 45 / 46 / 47 65 69 72	26 / 27 / 28 45 / 46 / 47 65 69 72	29 48 / 49	29 48 / 49	M MF UNC UNF UNEF UNJC UNJF G Rp RC NPT NPTF NPSF BSW BSF EG M EG UNC EG UNF Tr
75		75				76	76	76	77 81 81 82 83 84	77	77			
86 87 88				86 87 88							85	85		
HSSE-PM	HSSE-PM	HSSE-PM	HSSE-PM	HSSE-PM	HSSE-PM	HSSE	HSSE	HSSE	HSSE	HSSE	HSSE	HSSE-PM	HSSE-PM	Material
B/4-5P	B/4-5P	C/2-3P	C/2-3P	E/1,5-2P	E/1,5-2P	C/2-3P	B/4-5P	C/2-3P	C/2-3P	B/4-5P	C/2-3P	B/4-5P	C/2-3P	Nakrój
														Typ otworu
< 3xD	< 3xD	< 2,5xD	< 2,5xD	< 2,5xD	< 2,5xD	< 1,5xD	< 3xD	< 2,5xD	< 1,5xD	< 3xD	< 2,5xD	< 3xD	< 2,5xD	Chłodziwo
E/O/P	E/O/MQL	E/O/P	E/O/MQL	E/O/P	E/O/MQL	E/O/P	E/O/P	E/O/P	E/O/P	E/O/P	E/O/P	E/O/P	E/O/P	
Vc (m/min)														
10-40	20-50	10-40	20-50	10-40	20-50	10-35	10-35	10-35	5-20	5-20	5-20	10-35	10-35	P1
10-40	20-50	10-40	20-50	10-40	20-50	10-35	10-35	10-35	5-20	5-20	5-20	10-35	10-35	P2
10-40	20-50	10-40	20-50	10-40	20-50	10-35	10-35	10-35	5-20	5-20	5-20	10-35	10-35	P3
10-40	20-50	10-40	20-50	10-40	20-50	10-35	10-35	10-35	5-20	5-20	5-20	10-35	10-35	P4
10-40	20-50	10-40	20-50	10-40	20-50	5-20	5-20	5-20				5-20	5-20	P5
10-40	20-50	10-40	20-50	10-40	20-50	10-35	10-35	10-35	5-20	5-20	5-20	10-35	10-35	P6
10-40	20-50	10-40	20-50	10-40	20-50	5-20	5-20	5-20				5-20	5-20	P7
10-40	20-50	10-40	20-50	10-40	20-50							5-20	5-20	P8
5-15 ¹⁾	5-15 ¹⁾													P9
10-40	20-50	10-40	20-50	10-40	20-50	10-35	10-35	10-35	5-20	5-20	5-20	10-35	10-35	P10
10-40	20-50	10-40	20-50	10-40	20-50							5-20	5-20	P11
5-15 ¹⁾	5-15 ¹⁾													P12
5-15	5-25	5-15	5-25	5-15	5-25	5-15	5-15	5-15				5-15	5-15	P13
5-15	5-25	5-15	5-25	5-15	5-25	5-15	5-15	5-15				5-15	5-15	P14
5-15	5-25	5-15	5-25	5-15	5-25	5-15	5-15	5-15	5-10	5-10	5-10			M1
5-15	5-25	5-15	5-25	5-15	5-25	5-15	5-15	5-15	5-10	5-10	5-10	5-10	5-10	M2
5-15	5-25	5-15	5-25	5-15	5-25	5-15	5-15	5-15	5-10	5-10	5-10	5-10	5-10	M3
10-30	10-50	10-30	10-50	10-30	10-50	5-15	5-15		5-15	5-15		5-15	5-15	K1
10-30	10-50	10-30	10-50	10-30	10-50	5-15	5-15		5-15	5-15		5-15	5-15	K2
10-30	10-50	10-30	10-50	10-30	10-50	10-25	10-25	10-25	5-15	5-15	5-15	10-25	10-25	K3
10-30	10-50	10-30	10-50	10-30	10-50	10-25	10-25	10-25	5-15	5-15	5-15	10-25	10-25	K4
10-30	10-50	10-30	10-50	10-30	10-50	10-25	10-25	10-25	5-15	5-15	5-15	10-25	10-25	K5
5-15 ¹⁾	5-15 ¹⁾	5-15 ¹⁾	5-15 ¹⁾	5-15 ¹⁾	5-15 ¹⁾				5-15	5-15	5-15	10-25	10-25	K6
10-30	10-50	10-30	10-50	10-30	10-50									N1
10-30	10-50	10-30	10-50	10-30	10-50									N2
10-30	10-50	10-30	10-50	10-30	10-50	10-30	10-30	10-20	10-25	10-25	10-25	10-30	10-30	N3
10-30	10-50	10-30	10-50	10-30	10-50	10-30	10-30	10-20	10-25	10-25	10-25	10-30	10-30	N4
10-30	10-50	10-30	10-50	10-30	10-50	10-30	10-30	10-20	5-20	5-20	10-25	10-30	10-30	N5
10-30	10-50	10-30	10-50	10-30	10-50									N6
10-30	10-50	10-30	10-50	10-30	10-50	10-30	10-30	10-30	5-20	5-20	5-20	10-30	10-30	N7
10-30	10-50	10-30	10-50	10-30	10-50	10-30	10-30	10-30	5-20	5-20	5-20	10-30	10-30	N8
10-30	10-50	10-30	10-50	10-30	10-50									N9
5-25	5-25	5-25	5-25	5-25	5-25							10-30	10-30	N10
1-8 ¹⁾	1-8 ¹⁾	1-8 ¹⁾	1-8 ¹⁾	1-8 ¹⁾	1-8 ¹⁾									S1
1-8 ¹⁾	1-8 ¹⁾	1-8 ¹⁾	1-8 ¹⁾	1-8 ¹⁾	1-8 ¹⁾									S2
														S3
														S4
														S5
1-8 ¹⁾	1-8 ¹⁾	1-8 ¹⁾	1-8 ¹⁾	1-8 ¹⁾	1-8 ¹⁾									S6
														S7
														S8
														H1
														H2
														H3
														H4

1) - Dotyczy gwintowników ≥ M3





















































Nazwa	1400-HT			INOX				GG					GAL	
	C-TS	B-TS	C-R15-TS	B	B-HL	C-R40	C-R40-HL	C-TS	C-IK-TS	E-TS	E-IK-TS	E-IKR-TS	C-R15-TS	E-R15-IK-TS
M	29	29	29	30 / 31	30 / 31	30 / 31	30 / 31	32	32	32	32	32	32	32
MF	48 / 49	48 / 49	48 / 49	50 / 51 / 52	50 / 51 / 52	50 / 51 / 52	50 / 51 / 52	53 / 54	53 / 54	53 / 54	53 / 54	53 / 54	53 / 54	53 / 54
UNC														
UNF														
UNEF														
UNJC		73	73											
UNJF		74	74											
G														
Rp														
RC														
NPT														
NPTF														
NPSF														
BSW														
BSF														
EG M														
EG UNC														
EG UNF														
Tr														
Materiał	HSSE-PM	HSSE-PM	HSSE-PM	HSSE	HSSE	HSSE	HSSE	HSSE-PM	HSSE-PM	HSSE-PM	HSSE-PM	HSSE-PM	HSSE-PM	HSSE-PM
Nakrój	C/2-3P	B/4-5P	C/2-3P	B/4-5P	B/4-5P	C/2-3P	C/2-3P	C/2-3P	C/2-3P	E/1,5-2P	E/1,5-2P	E/1,5-2P	C/2-3P	E/1,5-2P
Typ otworu														
	< 1,5xD	< 2,5xD	< 1,5xD	< 3xD	< 3xD	< 2,5xD	< 2,5xD	< 2xD	< 2,5xD	< 2xD	< 2,5xD	< 2,5xD	< 2,5xD	< 2,5xD
Chłodziwo	E/O/P	E/O	E/O/P	E/O/P	E/O/P	E/O/P	E/O/P	E/O	E/O/MQL	E/O	E/O/MQL	E/O/MQL	E/O/P	E/O/MQL
Vc (m/min)														
P	P1													
	P2													
	P3													
	P4													
	P5	5-20	5-20	5-20										
	P6													
	P7	5-20	5-20	5-20										
	P8	5-20	5-20	5-20										
	P9	1-5	1-10	1-10										
	P10													
	P11	5-20	5-20	5-20										
	P12	1-5	1-10	1-10										
	P13													
	P14													
M	M1			5-15	5-25	5-15	5-25							
	M2	5-10	5-10	5-10	5-15	5-25	5-15	5-25						
	M3	1-8	1-8	1-8	5-10	5-10	5-10	5-10						
K	K1	10-20	10-20	10-20				20-60	20-60	20-60	20-60	20-60		
	K2							15-30	15-30	15-30	15-30	15-30		
	K3	10-20	10-20	10-20				15-30	15-30	15-30	15-30	15-30		
	K4	10-20	10-20	10-20				15-30	15-30	15-30	15-30	15-30		
	K5	10-20	10-20	10-20				15-30	15-30	15-30	15-30	15-30		
	K6	1-5	1-10	1-10				5-10	5-10	5-10	5-10	5-10		
N	N1													
	N2													
	N3			10-30									10-30	10-50
	N4			10-30									10-30	10-50
	N5			10-30									10-30	10-50
	N6													
	N7													
N8														
N9														
N10														
S	S1													
	S2													
	S3													
	S4													
	S5													
	S6													
	S7													
	S8													
H	H1													
	H2													
	H3													
	H4													





HRC60				S-NC			DIN-352	Ms	NUTAP	NGMF	NGST	KOMBI	BIT	Nazwa
C-HM-TC	C-IK-HM-TC	D-HM-TC	D-IK-HM-TC	B-TC	C-R45-TC	C-R45-IK-TC					TRAPEZ			
														M
33	33	33	33	34	34	34	35		36	37		38	39	MF
				55 / 56	55 / 56	55 / 56	57 / 58 / 59		60	61 / 62				UNC
							66							UNEF
							70							UNJC
								79	78	80				UNJF
														G
														Rp
														RC
														NPT
														NPTF
														NPSF
														BSW
														BSF
														EG M
														EG UNC
														EG UNF
											89			Tr
VHM	VHM	VHM	VHM	HSSE-PM	HSSE-PM	HSSE-PM	HSS	HSSE	HSSE	HSS	HSS	HSS	HSS	Materiał
C/2-3P	C/2-3P	D/3,5-5P	D/3,5-5P	B/4-5P	C/2-3P	C/2-3P	~3P	F/1P	12P	12P	24P	D/4P	D/4P	Nakrój
														Typ otworu
< 1,5xD	< 1,5xD	< 1,5xD	< 1,5xD	< 2,5xD	< 3xD	< 3xD	< 1,5xD	< 2xD	< 1,5xD	< 1,5xD	< 2xD	< 1,5xD	< 1,5xD	Chłodziwo
E/O/P	E/O/MQL	E/O/P	E/O/MQL	E/O/P	E/O/P	E/O/MQL	E/O/P	E/O/P	E/O/P	E/O/P	E/O/P	E/O/P	E/O/P	
				10-50	10-50	20-60	5-20		5-20	5-20	5-20	5-15	5-15	P1
				10-50	10-50	20-60	5-20		5-20	5-20	5-20	5-15	5-15	P2
				10-50	10-50	20-60	5-20		5-20	5-20	5-20	5-15	5-15	P3
				10-50	10-50	20-60	5-20		5-20	5-20	5-20	5-15	5-15	P4
				10-50	10-50	20-60			5-15					P5
				10-50	10-50	20-60	5-20		5-20	5-20	5-20	5-15	5-15	P6
				10-50	10-50	20-60			5-15					P7
				10-50	10-50	20-60			5-10					P8
				5-15 ¹⁾										P9
				10-50	10-50	20-60	5-20		5-20	5-20	5-20	5-15	5-15	P10
				10-50	10-50	20-60			5-15					P11
				5-15 ¹⁾										P12
				5-20	5-20	5-30								P13
				5-15	5-15	5-25								P14
				5-20	5-20	5-30								M1
				5-15	5-15	5-25								M2
				5-20	5-20	5-30								M3
				10-40	10-40	10-60				6-15	6-15			K1
				10-40	10-40	10-60								K2
				10-40	10-40	10-60								K3
				10-40	10-40	10-60								K4
				10-40	10-40	10-60								K5
				5-15 ¹⁾	5-15 ¹⁾	5-15 ¹⁾								K6
				10-40	10-40	10-60								N1
				10-40	10-40	10-60								N2
				10-40	10-40	10-60								N3
				10-40	10-40	10-60								N4
				10-40	10-40	10-60								N5
				10-40	10-40	10-60								N6
				10-40	10-40	10-60								N7
				10-40	10-40	10-60								N8
				10-40	10-40	10-60		10-25		6-15	6-15	6-15	6-15	N9
				5-25	5-25	5-30								N10
				1-8 ¹⁾	1-8 ¹⁾	1-8 ¹⁾								S1
				1-8 ¹⁾	1-8 ¹⁾	1-8 ¹⁾								S2
														S3
														S4
														S5
				1-8 ¹⁾	1-8 ¹⁾	1-8 ¹⁾								S6
														S7
														S8
	1-4	1-4	1-4	1-4										H1
	1-4	1-4	1-4	1-4										H2
	1-4	1-4	1-4	1-4										H3
	1-4	1-4	1-4	1-4										H4

1) - Dotyczy gwintowników ≥ M3

Nazwa	WGN						HRC			
	C-TN2	C-SR-TN2	C-SR-TC	E-SR-TC	E-SR-IK-TC	E-SR-IKR-TC				
										
M	93	93	93	93	93	93	101	102	103	104
MF		94	94				101	102	103	104
UNC		95								
UNF		96								
UNEUF										
G		97								
Material	PM/HSSE	PM/HSSE	PM/HSSE	PM/HSSE	PM/HSSE	PM/HSSE	VHM	VHM	VHM	VHM
Nakrój	C/2-3P	C/2-3P	C/2-3P	E/1,5-2P	E/1,5-2P	E/1,5-2P	-	-	-	-
Typ otworu	 < 3xD	 < 3xD	 < 3xD	 < 3xD	 < 3xD	 < 3xD				
Chłodziwo	E/O	E/O	E/O	E/O	E/O/MQL	E/O/MQL	E/O	E/O	E/O	E/O
P	P1	10-30	10-30	10-30	10-30	15-50	15-50	100-150	100-150	50-90
	P2	10-30	10-30	10-30	10-30	15-50	15-50	100-150	100-150	50-90
	P3	10-30	10-30	10-30	10-30	15-50	15-50	100-150	100-150	50-90
	P4	10-30	10-30	10-30	10-30	15-50	15-50	100-150	100-150	50-90
	P5	10-25	10-25	10-25	10-25	10-30	10-30	100-150	100-150	45-60
	P6	10-30	10-30	10-30	10-30	15-50	15-50	85-120	85-120	50-90
	P7	10-25	10-25	10-25	10-25	10-30	10-30	85-120	85-120	45-60
	P8							85-120	85-120	40-55
	P9							85-120	85-120	40-55
	P10	10-30	10-30	10-30	10-30	15-50	15-50	70-100	70-100	70-100
	P11			10-25	10-25	10-30	10-30	70-100	70-100	70-100
	P12							70-100	70-100	70-100
	P13			10-25	10-25	10-30	10-30	60-90	60-90	60-90
	P14							60-90	60-90	60-90
M	M1	10-25	10-25	10-25	10-25	10-25	10-25	60-90	60-90	60-90
	M2	10-25	10-25	10-25	10-25	10-25	10-25	60-90	60-90	60-90
	M3			10-25	10-25	10-25	10-25	50-70	50-70	50-70
K	K1							70-150	70-150	40-60
	K2							70-150	70-150	40-60
	K3							70-150	70-150	40-60
	K4							70-150	70-150	40-60
	K5							70-150	70-150	40-60
	K6									40-60
N	N1	20-40	20-40	20-60	20-60	20-60	20-60	150-220	150-220	60-180
	N2	20-40	20-40	20-60	20-60	20-60	20-60	150-220	150-220	60-180
	N3	20-40	20-40	20-60	20-60	20-60	20-60	150-220	150-220	60-180
	N4			20-60	20-60	20-60	20-60	150-220	150-220	60-180
	N5			20-60	20-60	20-60	20-60	100-180	100-180	60-180
	N6							100-180	100-180	60-180
	N7	20-40	20-40	20-60	20-60	20-60	20-60	100-180	100-180	60-180
	N8	20-40	20-40	20-60	20-60	20-60	20-60	100-180	100-180	60-180
	N9							100-180	100-180	60-180
	N10							100-180	100-180	60-180
S	S1								20-40	25-40
	S2								20-40	25-40
	S3								20-40	25-40
	S4								20-40	25-40
	S5								20-40	25-40
	S6								30-50	25-40
	S7								30-50	25-40
	S8								30-50	25-40
H	H1								55-70	
	H2								40-60	
	H3								35-50	
	H4									

Frez do małych gwintów

		INOX				HRC40	Nazwa
KPL/2	KPL/3	KPL/3-P	KPL/3-P-TN2	KPL/3-P-TS			
							
107 / 108 / 109	107 / 108 / 109	110	111	112		M	
113 / 114 / 115				116		MF	
	117					UNC	
118						UNF	
119		120		121		G	
	122					BSW	
123						BSF	
HSS C/2-3P	HSS C/2-3P	HSSE C/2-3P	HSSE C/2-3P	HSSE-PM C/2-3P		Material	
 < 2,5xD	 < 2,5xD	 < 2,5xD	 < 2,5xD	 < 1,5xD		Nakrój	
E/O/P	E/O/P	E/O/P	E/O/P	E/O/P		Typ otworu	
						P1	
						P2	
						P3	
						P4	
					P5		
						P6	
					P7		
					P8		
					P9		
						P10	
						P11	
						P12	
						P13	
						P14	
						M1	
						M2	
						M3	
						K1	
						K2	
						K3	
						K4	
						K5	
						K6	
						N1	
						N2	
						N3	
						N4	
						N5	
						N6	
						N7	
						N8	
						N9	
						N10	
						S1	
						S2	
						S3	
						S4	
						S5	
						S6	
						S7	
						S8	
						H1	
						H2	
						H3	
						H4	

Nazwa	800	800 SPN	Ms	INOX
				
M	127	127	127	127
MF	128 / 129 / 130	128 / 129 / 130	128 / 129 / 130	128 / 129 / 130
UNC	131			
UNF	132			
Słona	G	133	133	133
	R	134		
BSW	135			
BSF	136			
NPT	137			
Wykonanie		SPN - Skośna powierzchnia natarcia	Docierane; specjalna geometria	Docieranie; specjalna geometria
Materiał	HSS	HSS	HSS	HSSE
Nakrój	1,75P	1,75P	1,25P	2,25P
Chłodziwo	E/O/P	E/O/P	E/O/P	E/O/P
P	P1	4-8	4-8	4-8
	P2	3-6	3-6	3-6
	P3	3-6	3-6	3-6
	P4	2-5	2-5	3-6
	P5	2-5	2-5	3-6
	P6			
	P7			
	P8			
	P9			
	P10	1-3	1-3	1-5
	P11			1-5
	P12			
	P13			2-6
	P14			2-6
M	M1			2-6
	M2			2-6
	M3			
K	K1		5-8	
	K2		5-8	
	K3		5-8	
	K4		2-5	
	K5		2-5	
	K6			
N	N1			
	N2			
	N3	10-20	10-20	10-20
	N4	10-20	10-20	10-20
	N5			5-15
	N6			1-5
	N7	7-12	7-12	10-15
	N8	10-15	10-15	10-15
	N9			20-30
	N10			6-10
S	S1			
	S2			
	S3			
	S4			
	S5			
	S6			
	S7			
	S8			
H	H1			
	H2			
	H3			
	H4			

MASTERDRILL			X-DRILL				HRC		AL		INOX		
DIN-6537 3xD	DIN-6537 5xD	DIN-6537 8xD	DIN-6537 3xD	DIN-6537 5xD	DIN-6537	DIN-6539	DIN-6537 3xD	DIN-6537 5xD	DIN-6537 5xD	DIN-6537 5xD	DIN-338	DIN-338	Norma
m7	m7	m7	m7	m7	m7	h7	m7	m7	m7	m7	h8	h8	Tolerancja
141 - 143	144 - 146	147 - 149	141 - 143	144 - 146	160 - 161	159	150 - 152	153 - 155	156 - 158	156 - 158	162 - 164	162 - 164	Strona
$\lambda 35^{\circ} \pm 40^{\circ}$ $\delta 140^{\circ}$	$\lambda 35^{\circ} \pm 40^{\circ}$ $\delta 140^{\circ}$	$\lambda 35^{\circ} \pm 40^{\circ}$ $\delta 140^{\circ}$	$\lambda 35^{\circ} \pm 40^{\circ}$ $\delta 140^{\circ}$	$\lambda 35^{\circ} \pm 40^{\circ}$ $\delta 140^{\circ}$	$\lambda 35^{\circ} \pm 40^{\circ}$ $\delta 140^{\circ}$	$\lambda 35^{\circ} \pm 40^{\circ}$ $\delta 118^{\circ}$	$\lambda 35^{\circ} \pm 40^{\circ}$ $\delta 140^{\circ}$	$\lambda 35^{\circ} \pm 40^{\circ}$ $\delta 140^{\circ}$	$\lambda 15^{\circ}$ $\delta 130^{\circ}$	$\lambda 15^{\circ}$ $\delta 130^{\circ}$	$\lambda 36^{\circ}$ $\delta 130^{\circ}$	$\lambda 36^{\circ}$ $\delta 130^{\circ}$	Geometria
IK	IK	IK					IK	IK	IK	IK			Chłodzenie wewnętrzne
VHM	VHM	VHM	VHM	VHM	VHM	VHM	VHM	VHM	VHM	VHM	HSSE	HSSE	Materiał
AT	AT	AT	AT	AT	AT		TS	TS		TB		TN2	Rodzaj powłoki
3+20	3+20	3+20	3+20	3+20	2,35+14	0,75+2,9	3+20	3+20	3+20	3+20	1+16	1+16	Rodzaj średnic
110 c	100 c	50 c	70 c	60 c	70 a	55 a					35 c	40 c	P1
110 c	100 c	50 c	70 c	60 c	70 a	55 a					28 b	32 b	P2
100 c	90 c	50 c	70 c	60 c	70 a	55 a					28 b	32 b	P3
110 c	100 c	40 b	50 b	45 b	50 a	40 a					18 b	21 b	P4
100 c	90 c	40 b	50 b	45 b	50 a	40 a					18 b	21 b	P5
95 c	85 c	40 b	50 b	45 b	50 a	40 a					18 b	21 b	P6
85 c	75 c	30 b	40 b	35 b	40 a	30 a							P7
65 c	55 c	30 b	40 b	35 b	40 a	30 a							P8
65 c	55 c	25 b	30 b	30 b	30 a	25 a							P9
60 c	50 c	40 b	50 b	45 b	50 a	40 a					18 b	21 b	P10
55 c	45 c	30 b	40 b	35 b	40 a	30 a							P11
55 c	45 c	25 b	30 b	30 b	30 a	25 a							P12
60 c	50 c	40 b	50 b	45 b	50 a	40 a					13 b	15 b	P13
60 c	50 c	40 b	50 b	45 b	50 a	40 a					13 b	15 b	P14
60 b	50 b	25 b	30 b	30 b	30 a	25 a					10 b	12 b	M1
60 b	50 b												M2
60 b	50 b	25 b	30 b	30 b	30 a	25 a							M3
120 d	110 d	80 d	100 d	90 d	100 b	80 b					35 d	40 d	K1
95 d	85 d												K2
120 d	110 d	60 d	80 d	70 d	80 b	60 b							K3
100 d	90 d	60 d	80 d	70 d	80 b	60 b							K4
85 d	75 d	50 d	65 d	60 d	65 b	50 b							K5
85 d	75 d	50 d	65 d	60 d	65 b	50 b							K6
250 e	220 e	160 e	200 e	180 e	200 b	160 b			250 e	250 e	37 d	43 d	N1
250 e	220 e	160 e	200 e	180 e	200 b	160 b			250 e	250 e	37 d	43 d	N2
250 e	220 e	160 e	200 e	180 e	200 b	160 b			250 e	250 e	27 c	31 c	N3
250 e	220 e	160 e	200 e	180 e	200 b	160 b			250 e	250 e	27 c	31 c	N4
200 e	180 e	130 e	160 e	150 e	160 a	125 a			200 e	200 e	32 d	37 d	N5
200 e	180 e								150 d	150 d			N6
120 c	110 d	80 c	100 c	90 c	100 b	80 b			200 c	200 c	38 c	44 c	N7
150 c	135 c	100 c	120 c	110 c	120 b	100 b			200 c	200 c	41 b	47 b	N8
150 c	135 c	100 c	120 c	110 c	120 b	100 b			200 c	200 c	41 b	47 b	N9
150 c	135 c								200 c	200 c			N10
25 a	22 a	15 a	20 a	18 a	20 a	16 a					9 b	10 b	S1
25 a	22 a	15 a	20 a	18 a	20 a	16 a					9 b	10 b	S2
25 a	22 a												S3
25 a	22 a												S4
25 a	22 a												S5
60 b	50 b	30 b	40 b	35 b	40 a	30 a					24 b	28 b	S6
60 b	50 b	25 b	30 b	30 b	30 a	25 a					12 a	14 a	S7
60 b	50 b	25 b	30 b	30 b	30 a	25 a					12 a	14 a	S8
							40 b	40 b					H1
							35 b	35 b					H2
							30 b	30 b					H3
							35 b	35 b					H4























	WST	WDG	Nawiertaki			Fazowniki		Pogłębiacze				Rozwiertak
									Stożkowe	Fazownik PF	Walcowy	
												
Norma			NC	NC	DIN-333 A / B / R / EL	DIN-6537L	DIN-6537L	DIN-335	DIN-335		DIN-373	
Tolerancja												
Strona	165	166	167	167	168 - 171	172	172	174	174	176	177	178
Geometria			δ90°	δ120°		δ60°	δ90°	δ90°	δ90°	δ30 / 45 / 60°		
Chłodzenie wewnętrzne												
Materiał	HSS	VHM	HSSE	HSSE	HSSE / HSS / VHM	VHM	VHM	HSSE	VHM		HSS	HSS
Rodzaj powłoki	- / TN2	AT	TN2	TN2	TN2 / AT	AT	AT	- / TN2 / TC	AT	-	-	-
Rodzaj średnic		2,5+10,2	3+16	2,5+10,2	0,8+10	4+20	4+20					

TABELA ZALECANYCH POSUWÓW MM/OBR.

Grupa	Średnica wiertła											
	Ø 1	Ø 2	Ø 3	Ø 4	Ø 5	Ø 6	Ø 8	Ø 10	Ø 12	Ø 14	Ø 16	Ø 20
a	0,015	0,030	0,038	0,047	0,053	0,060	0,075	0,090	0,100	0,120	0,127	0,160
b	0,020	0,050	0,070	0,085	0,100	0,120	0,150	0,180	0,200	0,230	0,250	0,270
c	0,023	0,080	0,100	0,130	0,150	0,180	0,250	0,270	0,280	0,300	0,330	0,370
d	0,030	0,100	0,160	0,180	0,220	0,240	0,300	0,370	0,400	0,450	0,480	0,500
e	0,035	0,120	0,200	0,250	0,270	0,300	0,350	0,450	0,470	0,500	0,530	0,550
f	0,050	0,150	0,220	0,250	0,320	0,400	0,490	0,620	0,650	0,720	0,850	0,900
g	0,070	0,160	0,250	0,270	0,360	0,470	0,620	0,830	0,900	0,950	1,100	1,200
h	0,090	0,200	0,270	0,300	0,400	0,520	0,750	1,000	1,100	1,200	1,300	1,350

Symbole grup posuwów umieszczone są w tabeli doboru wiertel obok zalecanej prędkości skrawania

MASTERMILL				X-MILL									
440N	R440N	B440N	645	230	230L	B230	B230L	345	R345	440S	R440S		
Z=4	Z=4	Z=4	Z=6	Z=2	Z=2	Z=2	Z=2	Z=3	Z=3	Z=4	Z=4	Liczba ostrzy	
VHM	VHM	VHM	VHM	VHM	VHM	VHM	VHM	VHM	VHM	VHM	VHM	VHM	Materiał
TS	TS	TS	TS	AT	AT	AT	AT	AT	AT	AT	AT	AT	Powłoka
												Naroże	
181	181	182	183	184	185	186	187	188	188	189	189	Strona	
•	•	•	•	•	•	•	•	•	•	•	•	P1	
•	•	•	•	•	•	•	•	•	•	•	•	P2	
•	•	•	•	•	•	•	•	•	•	•	•	P3	
•	•	•	•	•	•	•	•	•	•	•	•	P4	
•	•	•	•	•	•	•	•	•	•	•	•	P5	
•	•	•	•	•	•	•	•	•	•	•	•	P6	
•	•	•	•	•	•	•	•	•	•	•	•	P7	
•	•	•	•	•	•	•	•	•	•	•	•	P8	
•	•	•	•	•	•	•	•	•	•	•	•	P9	
•	•	•	•	•	•	•	•	•	•	•	•	P10	
•	•	•	•	•	•	•	•	•	•	•	•	P11	
•	•	•	•	•	•	•	•	•	•	•	•	P12	
•	•	•	•	•	•	•	•	•	•	•	•	P13	
•	•	•	•	•	•	•	•	•	•	•	•	P14	
•	•	•	•					○	○	○	○	M1	
•	•	•	•					○	○	○	○	M2	
•	•	•	•					○	○	○	○	M3	
•	•	•	•	•	•	•	•	•	•	•	•	K1	
•	•	•	•	•	•	•	•	•	•	•	•	K2	
•	•	•	•	•	•	•	•	•	•	•	•	K3	
•	•	•	•	•	•	•	•	•	•	•	•	K4	
•	•	•	•	•	•	•	•	•	•	•	•	K5	
•	•	•	•	•	•	•	•	•	•	•	•	K6	
○	○	○	○					○	○	○	○	N1	
○	○	○	○					○	○	○	○	N2	
○	○	○	○					○	○	○	○	N3	
○	○	○	○					○	○	○	○	N4	
○	○	○	○					○	○	○	○	N5	
○	○	○	○	○	○	○	○	○	○	○	○	N6	
○	○	○	○	○	○	○	○	○	○	○	○	N7	
○	○	○	○	○	○	○	○	○	○	○	○	N8	
○	○	○	○	○	○	○	○	○	○	○	○	N9	
○	○	○	○	○	○	○	○	○	○	○	○	N10	
•	•	•	•					○	○	○	○	S1	
•	•	•	•					○	○	○	○	S2	
•	•	•	•					○	○	○	○	S3	
•	•	•	•					○	○	○	○	S4	
•	•	•	•					○	○	○	○	S5	
•	•	•	•					○	○	○	○	S6	
•	•	•	•					○	○	○	○	S7	
•	•	•	•					○	○	○	○	S8	
○	○	○	○									H1	
												H2	
												H3	
												H4	

		X-MILL									ZGR	
		440N	R440N	440NL	R440NL	430L	R430L	B440	540	R540	420	540N
												
Liczba ostrzy		Z=4	Z=4	Z=4	Z=4	Z=4	Z=4	Z=4	Z=5	Z=6	Z=3-4	Z=4-6
Materiał		VHM	VHM	VHM	VHM	VHM	VHM	VHM	VHM	VHM	VHM	VHM
Powłoka		AT	AT	AT	AT	AT	AT	AT	AT	AT	AT	TS
Naroże												
Strona		190 - 191	190 - 191	192	192	193	193	194	195	195	196	197
P	P1	●	●	●	●	●	●	●	●	●	●	●
	P2	●	●	●	●	●	●	●	●	●	●	●
	P3	●	●	●	●	●	●	●	●	●	●	●
	P4	●	●	●	●	●	●	●	●	●	●	●
	P5	●	●	●	●	●	●	●	●	●	●	●
	P6	●	●	●	●	●	●	●	●	●	●	●
	P7	●	●	●	●	●	●	●	●	●	●	●
	P8	●	●	●	●	●	●	●	●	●	●	●
	P9	●	●	●	●	●	●	●	●	●	●	●
	P10	●	●	●	●	●	●	●	●	●	●	●
	P11	●	●	●	●	●	●	●	●	●	●	●
	P12	●	●	●	●	●	●	●	●	●	●	●
	P13	●	●	●	●	●	●	●	●	●	●	●
	P14	●	●	●	●	●	●	●	●	●	●	●
M	M1	○	○	○	○			○	○	○	○	○
	M2	○	○	○	○			○	○	○	○	○
	M3	○	○	○	○			○	○	○	○	○
K	K1	●	●	●	●	●	●	●	●	●	○	○
	K2	●	●	●	●	●	●	●	●	●	○	○
	K3	●	●	●	●	●	●	●	●	●	○	○
	K4	●	●	●	●	●	●	●	●	●	○	○
	K5	●	●	●	●	●	●	●	●	●	○	○
	K6	●	●	●	●	●	●	●	●	●	○	○
N	N1	○	○	○	○			○	○	○		
	N2	○	○	○	○			○	○	○		
	N3	○	○	○	○			○	○	○		
	N4	○	○	○	○			○	○	○		
	N5	○	○	○	○			○	○	○		
	N6											
	N7	○	○	○	○	○	○	○	○	○		
	N8	○	○	○	○	○	○	○	○	○		
	N9	○	○	○	○	○	○	○	○	○		
	N10	○	○	○	○	○	○	○	○	○		
S	S1	○	○	○	○			○	○	○		
	S2	○	○	○	○			○	○	○		
	S3	○	○	○	○			○	○	○		
	S4	○	○	○	○			○	○	○		
	S5	○	○	○	○			○	○	○		
	S6	○	○	○	○			○	○	○		
	S7	○	○	○	○			○	○	○		
	S8	○	○	○	○			○	○	○		
H	H1										●	●
	H2										○	○
	H3											
	H4										○	○

HRC			AL										MultiCUT		Stożkowy	
HFM 200	B415N	R645	130	245	R245	B245	345	R345	345NL	B345NL	445	R338				
Z=2	Z=4	Z=6	Z=1	Z=2	Z=2	Z=2	Z=3	Z=3	Z=3	Z=3	Z=4	Z=3	Z=2	Z=4	Liczba ostrzy	
VHM	VHM	VHM	VHM	VHM	VHM	VHM	VHM	VHM	VHM	VHM	VHM	VHM	VHM	VHM	Materiał	
AD	TS	TS	PVD	PVD	TB	PVD	TB	TB	PVD	TB	PVD	TB	TB	TB	Powłoka	
																Powłoka
																Naróże
198	199	200	201	202 - 203	202 - 203	204	205 - 208	205 - 208	209	210	211	212	213	214	Strona	
○													●	●	P1	
○													●	●	P2	
○													●	●	P3	
○													●	●	P4	
●													●	●	P5	
○													●	●	P6	
●													●	●	P7	
●													●	●	P8	
○													●	●	P9	
●													●	●	P10	
●													●	●	P11	
●													●	●	P12	
○													●	●	P13	
●													●	●	P14	
													●	○	M1	
													●	○	M2	
													●	○	M3	
●													●	●	K1	
●													●	●	K2	
●													●	●	K3	
●													●	●	K4	
●													●	●	K5	
●													●	●	K6	
			●	●	●	●	●	●	●	●	●	●	●	○	N1	
			●	●	●	●	●	●	●	●	●	●	●	○	N2	
			●	●	●	●	●	●	●	●	●	●	●	○	N3	
			●	●	●	●	●	●	●	●	●	●	●	○	N4	
			●	●	●	●	●	●	●	●	●	●	●	○	N5	
			●	●	●	●	●	●	●	●	●	●	●	○	N6	
			●	●	●	●	●	●	●	●	●	●	●	○	N7	
			●	●	●	●	●	●	●	●	●	●	●	○	N8	
			●	●	●	●	●	●	●	●	●	●	●	○	N9	
			●	●	●	●	●	●	●	●	●	●	●	○	N10	
													○	○	S1	
													○	○	S2	
													○	○	S3	
													○	○	S4	
													○	○	S5	
													○	○	S6	
													○	○	S7	
													○	○	S8	
●	●	●													H1	
○	●	●													H2	
	●	●													H3	
○	●	●													H4	

MasterTAP						BOOX				BOO		FAN-I200		Nazwa
B-HL	B-WHL	C-R45-HL	C-R45-KHL	E-R45-HL	E-R45-KHL	C-TN	B-TN	C-R40-TN	C	B	C-R40	B-TC	C-R40-TC	
15 / 16	15 / 16	15 / 16	15 / 16	15 / 16	15 / 16	17 / 18	17 / 18	17 / 18	19 / 20	18 / 20 / 22	21 / 22 / 23	24	24	M
35 / 38	35 / 38	35 / 38	35 / 38	35 / 38	35 / 38	37 / 39	37 / 39	37 / 39	38 / 41	37 / 41 / 43	37 / 41 / 42	42 / 44	42 / 44	M
62	62	62	62	62	62	63	63	63	64	64	64	64	64	M
68	68	68	68	68	68	69	69	69	70	70	70	70	70	M
76	76	76	76	76	76	77	77	77	78	78	78	78	78	M
81	81	81	81	81	81	81	81	81	81	81	81	81	81	M
HSSE-PM	HSSE-PM	HSSE-PM	HSSE-PM	HSSE-PM	HSSE-PM	HSSE-PM	HSSE-PM	HSSE-PM	HSSE-PM	HSSE-PM	HSSE-PM	HSSE-PM	HSSE-PM	
Bk4.5	Bk4.5	C2.3	C2.3	E11.5.3	E11.5.3	C2.3	Bk4.5	C2.3	C2.3	Dk4.5	C2.3	Bk4.5	C2.3	
E/DIP	E/DIP	E/DIP	E/DIP	E/DIP	E/DIP	E/DIP	E/DIP	E/DIP	E/DIP	E/DIP	E/DIP	E/DIP	E/DIP	

1 Materiał obrabiany

Grupa	Symbol	Opis	15/16	17/18	19/20	21/22/23	24	25	26	27	28	29	30	31	32	33	34	35	36	37	38	39	40	41	42	43	44					
P	Stal	P1 Stal automatowa	10-40	20-50	10-40	20-50	10-40	20-50	10-35	10-35	10-35	5-20	5-30	5-20	10-35	10-35																
		P2 Stal węglowa C < 0.05 % węgla	10-40	20-50	10-40	20-50	10-40	20-50	10-35	10-35	10-35	5-20	5-30	5-20	10-35	10-35																
		P3 Stal węglowa C < 0.05 % węgla	10-40	20-50	10-40	20-50	10-40	20-50	10-35	10-35	10-35	5-20	5-30	5-20	10-35	10-35																
		P4 Stal węglowa C < 0.05 % węgla	10-40	20-50	10-40	20-50	10-40	20-50	10-35	10-35	10-35	5-20	5-30	5-20	10-35	10-35																
		P5 Stal niskostopowa C < 0.05 % utęszana cieplnie	10-40	20-50	10-40	20-50	10-40	20-50	10-35	10-35	10-35	5-20	5-30	5-20	10-35	10-35																
		P6 Stal niskostopowa	10-40	20-50	10-40	20-50	10-40	20-50	10-35	10-35	10-35	5-20	5-30	5-20	10-35	10-35																
		P7 Stal niskostopowa	10-40	20-50	10-40	20-50	10-40	20-50	10-35	10-35	10-35	5-20	5-30	5-20	10-35	10-35																
		P8 Stal niskostopowa	10-40	20-50	10-40	20-50	10-40	20-50	10-35	10-35	10-35	5-20	5-30	5-20	10-35	10-35																
		P9 Stal niskostopowa	10-40	20-50	10-40	20-50	10-40	20-50	10-35	10-35	10-35	5-20	5-30	5-20	10-35	10-35																
		P10 Stal wysokostopowa i wysokostopowa stal narzędziowa	5-15	5-15	5-15	5-15	5-15	5-15	5-15	5-15	5-15	5-15	5-15	5-15	5-15	5-15																
		P11 Stal wysokostopowa i wysokostopowa stal narzędziowa	10-40	20-50	10-40	20-50	10-40	20-50	10-35	10-35	10-35	5-20	5-30	5-20	10-35	10-35																
		P12 Stal nierdzewna	5-15	5-15	5-15	5-15	5-15	5-15	5-15	5-15	5-15	5-15	5-15	5-15	5-15	5-15																
		P13 Stal nierdzewna	5-15	5-15	5-15	5-15	5-15	5-15	5-15	5-15	5-15	5-15	5-15	5-15	5-15	5-15																
		P14 Stal nierdzewna	5-15	5-15	5-15	5-15	5-15	5-15	5-15	5-15	5-15	5-15	5-15	5-15	5-15	5-15																

Wykonanie narzędzia **4**

Gwint metryczny DIN-13															
800															
C C-LH B B-LH B B															
Rodzaj materiału obrabianego	P	K	N	P	K	N	P	K	N	P	K	N	P	K	N
Typ otworu	1.5	1.5	1.5	1.5	1.5	1.5	1.5	1.5	1.5	1.5	1.5	1.5	1.5	1.5	1.5
Materiał	HSSE	HSSE	HSSE	HSSE	HSSE	HSSE	HSSE	HSSE	HSSE	HSSE	HSSE	HSSE	HSSE	HSSE	HSSE
Rodzaj powłoki															
Nakrój	C / 2-3P	C / 2-3P	B / 4-5P	B / 4-5P	B / 4-5P	B / 4-5P	B / 4-5P	B / 4-5P	B / 4-5P	B / 4-5P	B / 4-5P	B / 4-5P	B / 4-5P	B / 4-5P	B / 4-5P
M	0.25	0.30	0.40	0.50	0.60	0.70	0.80	1.00	1.25	1.50	2.00	2.50	3.00	4.00	5.00
INDEX	0010	0011	0012	0014	0016	0017	0018	0020	0022	0023	0025	0026	0030	0035	0040
Tolerancja	ISO1 (4H)	ISO1 (4H)	ISO1 (4H)	ISO1 (4H)	ISO2 (6H)	ISO2 (6H)	ISO2 (6H)	ISO2 (6H)	ISO2 (6H)	ISO2 (6H)	ISO2 (6H)	ISO2 (6H)	ISO2 (6H)	ISO2 (6H)	ISO2 (6H)
M	0.25	0.30	0.40	0.50	0.60	0.70	0.80	1.00	1.25	1.50	2.00	2.50	3.00	4.00	5.00
INDEX	0010	0011	0012	0014	0016	0017	0018	0020	0022	0023	0025	0026	0030	0035	0040
Tolerancja	ISO2 (6H)	ISO2 (6H)	ISO2 (6H)	ISO2 (6H)	ISO2 (6H)	ISO2 (6H)	ISO2 (6H)	ISO2 (6H)	ISO2 (6H)	ISO2 (6H)	ISO2 (6H)	ISO2 (6H)	ISO2 (6H)	ISO2 (6H)	ISO2 (6H)
M	0.50	0.60	0.70	0.80	1.00	1.25	1.50	2.00	2.50	3.00	4.00	5.00	6.00	8.00	10.00
INDEX	0030	0035	0040	0045	0050	0060	0070	0080	0090	0100					
Tolerancja	ISO2 (6H)	ISO2 (6H)	ISO2 (6H)	ISO2 (6H)	ISO2 (6H)	ISO2 (6H)	ISO2 (6H)	ISO2 (6H)	ISO2 (6H)	ISO2 (6H)	ISO2 (6H)	ISO2 (6H)	ISO2 (6H)	ISO2 (6H)	ISO2 (6H)

M	0.25	0.30	0.40	0.50	0.60	0.70	0.80	1.00	1.25	1.50	2.00	2.50	3.00	4.00	5.00
M4.5	0.75	70	14	-	25	6.0	4.9	3.80	0045	•	•	•	•	•	•
M5	0.80	70	14	-	25	6.0	4.9	4.20	0050	•	•	•	•	•	•
M6	1.00	80	18	-	30	6.0	4.9	5.00	0060	•	•	•	•	•	•
M7	1.00	80	18	-	30	7.0	5.5	6.00	0070	•	•	•	•	•	•
M8	1.25	90	20	-	35	8.0	6.2	6.80	0080	•	•	•	•	•	•
M9	1.25	90	20	-	35	9.0	7.0	7.80	0090	•	•	•	•	•	•
M10	1.50	100	20	-	39	10.0	8.0	8.50	0100	•	•	•	•	•	•

Prędkość skrawania **7**

JAK DOBRAĆ PRODUKT?

1. W tabeli doboru odszukać materiał obrabiany
2. Wybrać wykonanie w danej grupie narzędzi
3. Odszukać nr strony w katalogu dla wybranego rodzaju gwintu
4. Odszukać wykonanie narzędzia na wskazanej stronie katalogowej
5. Wybrać właściwy wymiar gwintu
6. Zbudować indeks i nazwę np. **C2-221101-0080 Gwintownik 800 M8-6H DIN-371 C LH HSSE**
7. Sprawdzić polecaną prędkość skrawania

5 Wymiar gwintu

Indeks i nazwa **6**

SPIIS TREŚCI

STRONA

15 - 90	GWINTOWNIKI MASZYNOWE	1
91 - 98	WYGNIA TAKI	2
99 - 104	FREZY DO GWINTÓW	3
105 - 124	GWINTOWNIKI RĘCZNE	4
125 - 138	NARZYNKI	5
139 - 178	NARZĘDZIA WIERTARSKIE	6
179 - 214	FREZY	7
215 - 228	SPRAWDZIANY	8
229 - 250	OPRAWKI MASZYNOWE	9
251 - 264	ZESTAWY NARZĘDZI	10
265 - 274	AKCESORIA I MASZYNY DO GWINTOWANIA	11
275 - 340	INFORMACJE TECHNICZNE	12



GWINTOWNIKI
MASZYNOWE



TABELA DOBORU NARZĘDZI

1 - 3

STRONY KATALOGOWE

17 - 89

M	DIN-371 DIN-376	Gwintowniki maszynowe wysokowydajne	MASTER TAP 800X 800	17 - 27
	DIN-371 EL DIN-376 EL	Gwintowniki maszynowe wysokowydajne z chwytem wydłużonym	800X 800	28
	DIN-371 DIN-376	Gwintowniki maszynowe wysokowydajne	FAN-1200 I400-HT INOX GG GAL HRC60 S-NC	29 - 34
	DIN-352	Gwintowniki maszynowe krótkie		35
	NUT-TAP NGMf KOMBI BIT	Gwintowniki maszynowe do nakrętek Wiertło-Gwintownik Gwintowniki maszynowe - BITS	NUT-TAP NGMf BIT KOMBI	36 - 39
MF	DIN-371 DIN-374	Gwintowniki maszynowe wysokowydajne	MASTER TAP 800X 800 FAN-1200 I400-HT INOX GG GAL S-NC	40 - 56
	DIN-2181	Gwintowniki maszynowe krótkie		57 - 59
	NUT-TAP NGMf	Gwintowniki maszynowe do nakrętek	NUT-TAP NGMf	60 - 62
UNC	DIN-371 DIN-376	Gwintowniki maszynowe wysokowydajne	MASTER TAP 800X 800	63 - 65
	DIN-352	Gwintowniki maszynowe krótkie		66
UNF	DIN-371 DIN-374	Gwintowniki maszynowe wysokowydajne	MASTER TAP 800X 800	67 - 69
	DIN-2181	Gwintowniki maszynowe krótkie		70
UNEF	~DIN-374	Gwintowniki maszynowe wysokowydajne	800X 800	71 - 72
UNJC	DIN-371 DIN-376	Gwintowniki maszynowe wysokowydajne	I400-HT	73
UNJF	DIN-371 DIN-374	Gwintowniki maszynowe wysokowydajne	I400-HT	74
G	DIN-5156	Gwintowniki maszynowe wysokowydajne	MASTER TAP 800X 800	75 - 77
	~DIN-5157	Gwintowniki maszynowe krótkie	Ms	78
	DIN-5157	Gwintowniki maszynowe krótkie		79
	NGRf	Gwintowniki maszynowe do nakrętek	NGRf	80
Rp/Rc	DIN-5156	Gwintowniki maszynowe wysokowydajne	800	81
	~DIN-5156	Gwintowniki maszynowe wysokowydajne	800	81
NPT	~DIN-371 ~DIN-374	Gwintowniki maszynowe wysokowydajne	800	82
NPTF	~DIN-374	Gwintowniki maszynowe wysokowydajne	800	83
NPSF	~DIN-374	Gwintowniki maszynowe wysokowydajne	800	84
BSW	DIN-371 DIN-376	Gwintowniki maszynowe wysokowydajne	800	85
EG ^M _{STI}	~DIN-371 ~DIN-376	Gwintowniki maszynowe wysokowydajne	MASTER TAP	86
EG ^{UNC} _{STI}	~DIN-371 ~DIN-376	Gwintowniki maszynowe wysokowydajne	MASTER TAP	87
EG ^{UNF} _{STI}	~DIN-371 ~DIN-376	Gwintowniki maszynowe wysokowydajne	MASTER TAP	88
TR	NGSt	Gwintowniki maszynowe	NGSt	89



MASTER TAP

Gwint metryczny ISO DIN-13										MASTER TAP									
										B-HL	B-IKR-HL	C-R45-HL	C-R45-IK-HL	E-R45-HL	E-R45-IK-HL				
Rodzaj materiału obrabianego										P M K N S H		P M K N S H		P M K N S H		P M K N S H		P M K N S H	
Typ otworu																			
Rodzaj materiału										HSSE-PM		HSSE-PM		HSSE-PM		HSSE-PM		HSSE-PM	
Rodzaj powłoki										HL		HL		HL		HL		HL	
Nakrój										B / 4-5P		B / 4-5P		C / 2-3P		C / 2-3P		E / 1,5-2P	
M Ød ₁	P	l ₁	l ₂	l ₂ R45	l ₃	Ød ₂	a		Norma										
									DIN-371						Tol.	ISO1(4H)			
										INDEX	C4-118M02		C4-528M02						
M1	0,25	40	6	6	13	2,5	2,1	0,75	0010	●			●						
M1,1	0,25	40	6	6	13	2,5	2,1	0,85	0011	●			●						
M1,2	0,25	40	6	6	13	2,5	2,1	0,95	0012	●			●						
M1,4	0,30	40	8	8	13	2,5	2,1	1,10	0014	●			●						
M Ød ₁	P	l ₁	l ₂	l ₂ R45	l ₃	Ød ₂	a		Norma										
									DIN-371						Tol.	ISO2 (6H)			
										INDEX	C4-118M01		C4-528M01						
M1,6	0,35	40	8	8	13	2,5	2,1	1,25	0016	●			●						
M1,7	0,35	40	8	8	13	2,5	2,1	1,35	0017	●			●						
M1,8	0,35	40	8	8	13	2,5	2,1	1,45	0018	●			●						
M2	0,40	45	10	10	13	2,8	2,1	1,60	0020	●			●						
M2,2	0,45	45	10	10	13	2,8	2,1	1,75	0022	●			●						
M2,3	0,40	45	10	10	13	2,8	2,1	1,90	0023	●			●						
M2,5	0,45	50	9	5	14	2,8	2,1	2,05	0025	●			●						
M2,6	0,45	50	9	5	14	2,8	2,1	2,15	0026	●			●						
M Ød ₁	P	l ₁	l ₂	l ₂ R45	l ₃	Ød ₂	a		Norma										
									DIN-371						Tol.	6HX	6HX	6HX	6HX
										INDEX	C4-118M01	C4-118M61	C4-528M01	C4-528M51	C4-718M01	C4-718M51			
M3	0,50	56	5	5	18	3,5	2,7	2,50	0030	●	-	●	-	●	-				
M3,5	0,60	56	6	6	20	4,0	3,0	2,90	0035	●	-	●	-	●	-				
M4	0,70	63	7	7	21	4,5	3,4	3,30	0040	●	-	●	-	●	-				
M4,5	0,75	70	7,5	7,5	25	6,0	4,9	3,80	0045	●	-	●	-	●	-				
M5	0,80	70	8	8	25	6,0	4,9	4,20	0050	●	●	●	●	●	○				
M6	1,00	80	10	10	30	6,0	4,9	5,00	0060	●	●	●	●	●	○				
M7	1,00	80	10	10	30	7,0	5,5	6,00	0070	●	○	○	○	○	○				
M8	1,25	90	13	13	35	8,0	6,2	6,80	0080	●	●	●	●	●	○				
M9	1,25	90	13	13	35	9,0	7,0	7,80	0090	○	○	○	○	○	○				
M10	1,50	100	15	15	39	10,0	8,0	8,50	0100	●	●	●	●	●	○				

- Dostępne z magazynu
- Na zapytanie

ISO	Vc (m/min)					
P	5-40	5-50	5-40	5-50	5-40	5-50
M	5-15	5-25	5-15	5-25	5-15	5-25
K	10-30	10-50	10-30	10-50	10-30	10-50
N	10-30	10-50	10-30	10-50	10-30	10-50
S	1-8	1-8	1-8	1-8	1-8	1-8

Przykład zamówienia
C4-118M01-0100
MasterTAP M10-6HX DIN-371 B HSSE-PM HL

1

Gwint metryczny ISO DIN-13

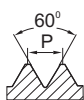
HSSE
PM

HL

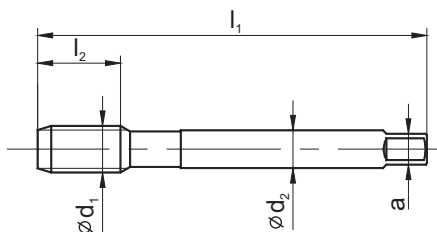
DIN
376

MASTER TAP

B-HL B-IKR-HL C-R45-HL C-R45-IK-HL E-R45-HL E-R45-IK-HL



Rodzaj materiału obrabianego



Typ otworu



Rodzaj materiału

HSSE-PM HSSE-PM HSSE-PM HSSE-PM HSSE-PM HSSE-PM

Rodzaj powłoki

HL HL HL HL HL HL

Nakrój

B / 4-5P B / 4-5P C / 2-3P C / 2-3P E / 1,5-2P E / 1,5-2P

M Ød ₁	P	l ₁	l ₂	l ₃	Ød ₂	a		Norma	DIN-376						
									Tol.	6HX	6HX	6HX	6HX	6HX	6HX
									INDEX	D4-118M01	D4-118M61	D4-528M01	D4-528M51	D4-718M01	D4-718M51
M8	1,25	90	15	-	6,0	4,9	6,80	0080	●	○	●	○	○	○	
M10	1,50	100	17	-	7,0	5,5	8,50	0100	●	○	●	○	○	○	
M12	1,75	110	18	-	9,0	7,0	10,20	0120	●	●	●	●	●	○	
M14	2,00	110	20	-	11,0	9,0	12,00	0140	●	●	●	●	●	○	
M16	2,00	110	20	-	12,0	9,0	14,00	0160	●	●	●	●	●	○	
M18	2,50	125	25	-	14,0	11,0	15,50	0180	●	○	●	○	○	○	
M20	2,50	140	25	-	16,0	12,0	17,50	0200	●	○	●	○	○	○	
M22	2,50	140	25	-	18,0	14,5	19,50	0220	●	○	●	○	○	○	
M24	3,00	160	30	-	18,0	14,5	21,00	0240	●	○	●	○	○	○	
M27	3,00	160	30	-	20,0	16,0	24,00	0270	●	○	●	○	○	○	
M30	3,50	180	35	-	22,0	18,0	26,50	0300	●	○	●	○	○	○	
M33	3,50	180	35	-	25,0	20,0	29,50	0330	●	○	●	○	○	○	
M36	4,00	200	40	-	28,0	22,0	32,00	0360	●	○	●	○	○	○	

ISO	V _c (m/min)					
P	5-40	5-50	5-40	5-50	5-40	5-50
M	5-15	5-25	5-15	5-25	5-15	5-25
K	10-30	10-50	10-30	10-50	10-30	10-50
N	10-30	10-50	10-30	10-50	10-30	10-50
S	1-8	1-8	1-8	1-8	1-8	1-8

MASTER TAP



Gwint metryczny ISO DIN-13										800X							
										C	C-LH	B	B-LH	B	B		
Rodzaj materiału obrabianego																	
Typ otworu																	
Rodzaj materiału										HSSE		HSSE		HSSE			
Rodzaj powłoki										TN2		TN2		TN2			
Nakrój										C / 2-3P		C / 2-3P		B / 4-5P			
M Ød ₁	P	l ₁	l ₂	l ₂ R40	l ₃	Ød ₂	a		Norma								
									DIN-371								
									Tol.	ISO1(4H)		ISO1(4H)					
										INDEX	C4-123X02		C4-113X02				
M1	0,25	40	6	-	13	2,5	2,1	0,75	0010	●			●				
M1,1	0,25	40	6	-	13	2,5	2,1	0,85	0011	●			●				
M1,2	0,25	40	6	-	13	2,5	2,1	0,95	0012	●			●				
M1,4	0,30	40	7	-	13	2,5	2,1	1,10	0014	●			●				
M Ød ₁	P	l ₁	l ₂	l ₂ R40	l ₃	Ød ₂	a		Norma								
									DIN-371								
									Tol.	ISO2 (6H)		ISO2 (6H)					
										INDEX	C4-123X01		C4-113X01				
M1,6	0,35	40	8	-	13	2,5	2,1	1,25	0016	●			●				
M1,7	0,35	40	8	-	13	2,5	2,1	1,35	0017	●			●				
M1,8	0,35	40	8	-	13	2,5	2,1	1,45	0018	●			●				
M2	0,40	45	10	-	13	2,8	2,1	1,60	0020	●			●				
M2,2	0,45	45	10	-	13	2,8	2,1	1,75	0022	●			●				
M2,3	0,40	45	10	-	13	2,8	2,1	1,90	0023	●			●				
M2,5	0,45	50	9	-	14	2,8	2,1	2,05	0025	●			●				
M2,6	0,45	50	9	-	14	2,8	2,1	2,15	0026	●			●				
M Ød ₁	P	l ₁	l ₂	l ₂ R40	l ₃	Ød ₂	a		Norma								
									DIN-371								
									Tol.	ISO2 (6H)	ISO2 (6H)	ISO2 (6H)	ISO2 (6H)	ISO3 (6G)	7G		
										INDEX	C2-123X01	C2-223X01	C2-113X01	C2-213X01	C2-113X03	C2-113X04	
M3	0,50	56	10	-	18	3,5	2,7	2,50	0030	●	●	●	●	●	○		
M3,5	0,60	56	12	-	20	4,0	3,0	2,90	0035	●	○	●	○	○	○		
M4	0,70	63	12	-	21	4,5	3,4	3,30	0040	●	●	●	●	●	○		
M4,5	0,75	70	14	-	25	6,0	4,9	3,80	0045	●	○	●	○	○	○		
M5	0,80	70	14	-	25	6,0	4,9	4,20	0050	●	●	●	●	●	○		
M6	1,00	80	18	-	30	6,0	4,9	5,00	0060	●	●	●	●	●	○		
M7	1,00	80	18	-	30	7,0	5,5	6,00	0070	●	○	●	○	○	○		
M8	1,25	90	20	-	35	8,0	6,2	6,80	0080	●	●	●	●	●	○		
M9	1,25	90	20	-	35	9,0	7,0	7,80	0090	●	○	●	○	○	○		
M10	1,50	100	20	-	39	10,0	8,0	8,50	0100	●	●	●	●	●	○		
										V _c (m/min)							
										P	M	K	N	S			
										5-35	5-15	5-25	10-30	-			
										5-35	5-15	5-25	10-30	-			
										5-35	5-15	5-25	10-30	-			
										5-35	5-15	5-25	10-30	-			
										5-35	5-15	5-25	10-30	-			
										5-35	5-15	5-25	10-30	-			

- Dostępne z magazynu
- Na zapytanie

Gwint metryczny ISO DIN-13

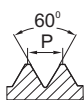

HSSE

TN2

DIN 376

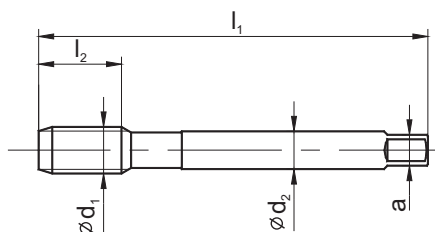

800X

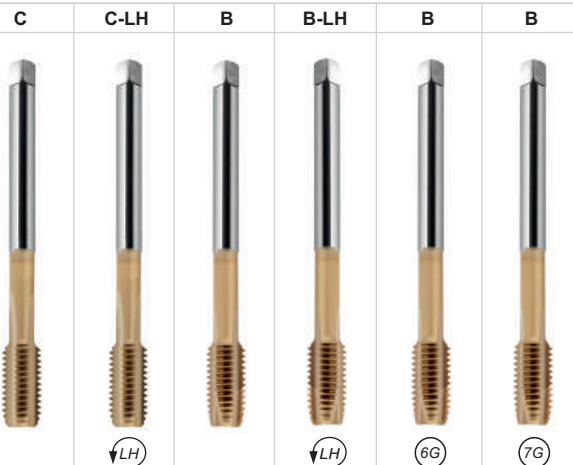

Rodzaj materiału obrabianego



Typ otworu



Rodzaj materiału

HSSE HSSE HSSE HSSE HSSE HSSE

Rodzaj powłoki

TN2 TN2 TN2 TN2 TN2 TN2

Nakrój

C / 2-3P C / 2-3P B / 4-5P B / 4-5P B / 4-5P B / 4-5P

M $\varnothing d_1$	P	l_1	l_2	l_{R40}	l_3	$\varnothing d_2$	a		Norm	DIN-376					
									Tol.	ISO2 (6H)	ISO2 (6H)	ISO2 (6H)	ISO2 (6H)	ISO3 (6G)	7G
									INDEX	D2-123X01	D2-223X01	D2-113X01	D2-213X01	D2-113X03	D2-113X04
M3	0,50	56	11	-	-	2,2	1,8	2,50	0030	●	○	●	○	○	○
M4	0,70	63	12	-	-	2,8	2,1	3,30	0040	●	○	●	○	○	○
M5	0,80	70	14	-	-	3,5	2,7	4,20	0050	●	○	●	○	○	○
M6	1,00	80	18	-	-	4,5	3,4	5,00	0060	●	○	●	○	○	○
M8	1,25	90	20	-	-	6,0	4,9	6,80	0080	●	○	●	○	○	○
M10	1,50	100	20	-	-	7,0	5,5	8,50	0100	●	○	●	○	○	○
M12	1,75	110	24	-	-	9,0	7,0	10,20	0120	●	●	●	●	●	○
M14	2,00	110	25	-	-	11,0	9,0	12,00	0140	●	○	●	○	○	○
M16	2,00	110	32	-	-	12,0	9,0	14,00	0160	●	●	●	●	●	○
M18	2,50	125	32	-	-	14,0	11,0	15,50	0180	●	○	●	○	○	○
M20	2,50	140	32	-	-	16,0	12,0	17,50	0200	●	●	●	●	●	○
M22	2,50	140	32	-	-	18,0	14,5	19,50	0220	●	○	●	○	○	○
M24	3,00	160	38	-	-	18,0	14,5	21,00	0240	●	●	●	●	○	○
M27	3,00	160	38	-	-	20,0	16,0	24,00	0270	●	○	●	○	○	○
M30	3,50	180	45	-	-	22,0	18,0	26,50	0300	●	○	●	○	○	○
M33	3,50	180	45	-	-	25,0	20,0	29,50	0330	●	○	●	○	○	○
M36	4,00	200	50	-	-	28,0	22,0	32,00	0360	●	○	●	○	○	○
M39	4,00	200	50	-	-	32,0	24,0	35,00	0390	●	○	●	○	○	○
M42	4,50	200	60	-	-	32,0	24,0	37,50	0420	●	○	●	○	○	○
M45	4,50	220	60	-	-	36,0	29,0	40,50	0450	●	○	●	○	○	○
M48	5,00	250	65	-	-	36,0	29,0	43,00	0480	●	○	●	○	○	○
M52	5,00	250	65	-	-	40,0	32,0	47,00	0520	●	○	●	○	○	○

ISO	Vc (m/min)					
P	5-35	5-35	5-35	5-35	5-35	5-35
M	5-15	5-15	5-15	5-15	5-15	5-15
K	5-25	5-25	5-25	5-25	5-25	5-25
N	10-30	10-30	10-30	10-30	10-30	10-30
S	-	-	-	-	-	-



Gwint metryczny ISO DIN-13										800X							
										C-R40	C-LH-L40	C-R40	C-R40				
Rodzaj materiału obrabianego																	
Typ otworu																	
Rodzaj materiału										HSSE							
Rodzaj powłoki										TN2							
Nakrój										C / 2-3P							
M	\varnothing_{d_1}	P	l_1	l_2	l_{R40}	l_3	\varnothing_{d_2}	a		Norma							
										DIN-371							
										Tol.				ISO1(4H)			
										INDEX				C4-513X02			
M1	0,25	40	-	6	13	2,5	2,1	0,75		0010	●						
M1,1	0,25	40	-	6	13	2,5	2,1	0,85		0011	●						
M1,2	0,25	40	-	6	13	2,5	2,1	0,95		0012	●						
M1,4	0,30	40	-	8	13	2,5	2,1	1,10		0014	●						
M	\varnothing_{d_1}	P	l_1	l_2	l_{R40}	l_3	\varnothing_{d_2}	a		Norma							
										DIN-371							
										Tol.				ISO2 (6H)			
										INDEX				C4-513X01			
M1,6	0,35	40	-	8	13	2,5	2,1	1,25		0016	●						
M1,7	0,35	40	-	8	13	2,5	2,1	1,35		0017	●						
M1,8	0,35	40	-	8	13	2,5	2,1	1,45		0018	●						
M2	0,40	45	-	10	13	2,8	2,1	1,60		0020	●						
M2,2	0,45	45	-	10	13	2,8	2,1	1,75		0022	●						
M2,3	0,40	45	-	10	13	2,8	2,1	1,90		0023	●						
M2,5	0,45	50	-	5	14	2,8	2,1	2,05		0025	●						
M2,6	0,45	50	-	5	14	2,8	2,1	2,15		0026	●						
M	\varnothing_{d_1}	P	l_1	l_2	l_{R40}	l_3	\varnothing_{d_2}	a		Norma							
										DIN-371							
										Tol.				ISO2 (6H) ISO2 (6H) ISO3 (6G) 7G			
										INDEX				C2-513X01 C2-593X01 C2-513X03 C2-513X04			
M3	0,50	56	-	5	18	3,5	2,7	2,50		0030	●	●	●	○			
M3,5	0,60	56	-	6	20	4,0	3,0	2,90		0035	●	○	○	○			
M4	0,70	63	-	7	21	4,5	3,4	3,30		0040	●	●	●	○			
M4,5	0,75	70	-	7,5	25	6,0	4,9	3,80		0045	●	○	○	○			
M5	0,80	70	-	8	25	6,0	4,9	4,20		0050	●	●	●	○			
M6	1,00	80	-	10	30	6,0	4,9	5,00		0060	●	●	●	○			
M7	1,00	80	-	10	30	7,0	5,5	6,00		0070	●	○	○	○			
M8	1,25	90	-	13	35	8,0	6,2	6,80		0080	●	●	●	○			
M9	1,25	90	-	13	35	9,0	7,0	7,80		0090	●	○	○	○			
M10	1,50	100	-	15	39	10,0	8,0	8,50		0100	●	●	●	○			
										ISO				Vc (m/min)			
										P				5-35			
										M				5-15			
										K				5-25			
										N				10-30			
										S				-			

- Dostępne z magazynu
- Na zapytanie

1

Gwint metryczny ISO DIN-13



HSSE

TN2

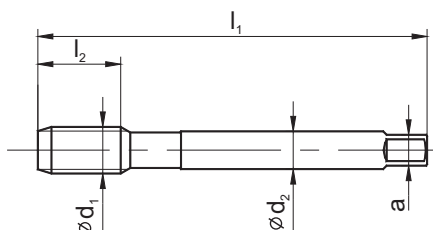
DIN
376

800X

C-R40

C-LH-L40

C-R40

C-R40



LH

6G

7G

Rodzaj materiału obrabianego

P

M

K

N

S

H

P

M

K

N

S

H

P

M

K

N

S

H

P

M

K

N

S

H

Typ otworu



<math>< 2,5d</math>

<math>< 2,5d</math>

<math>< 2,5d</math>

<math>< 2,5d</math>

Rodzaj materiału

HSSE

HSSE

HSSE

HSSE

Rodzaj powłoki

TN2

TN2

TN2

TN2

Nakrój

C / 2-3P

C / 2-3P

C / 2-3P

C / 2-3P

M $\varnothing d_1$	P	l_1	l_2	l_{R40}	l_3	$\varnothing d_2$	a		Norma				
									DIN-376				
									Tol.	ISO2 (6H)	ISO2 (6H)	ISO3 (6G)	7G
INDEX	D2-513X01	D2-593X01	D2-513X03	D2-513X04									
M3	0,50	56	-	5	-	2,2	1,8	2,50	0030	●	○	○	○
M4	0,70	63	-	8	-	2,8	2,1	3,30	0040	●	○	○	○
M5	0,80	70	-	10	-	3,5	2,7	4,20	0050	●	○	○	○
M6	1,00	80	-	12	-	4,5	3,4	5,00	0060	●	○	○	○
M8	1,25	90	-	15	-	6,0	4,9	6,80	0080	●	○	○	○
M10	1,50	100	-	17	-	7,0	5,5	8,50	0100	●	○	○	○
M12	1,75	110	-	18	-	9,0	7,0	10,20	0120	●	●	●	○
M14	2,00	110	-	20	-	11,0	9,0	12,00	0140	●	○	○	○
M16	2,00	110	-	20	-	12,0	9,0	14,00	0160	●	●	●	○
M18	2,50	125	-	25	-	14,0	11,0	15,50	0180	●	○	○	○
M20	2,50	140	-	25	-	16,0	12,0	17,50	0200	●	●	●	○
M22	2,50	140	-	25	-	18,0	14,5	19,50	0220	●	○	○	○
M24	3,00	160	-	30	-	18,0	14,5	21,00	0240	●	●	○	○
M27	3,00	160	-	30	-	20,0	16,0	24,00	0270	●	○	○	○
M30	3,50	180	-	35	-	22,0	18,0	26,50	0300	●	○	○	○
M33	3,50	180	-	35	-	25,0	20,0	29,50	0330	●	○	○	○
M36	4,00	200	-	40	-	28,0	22,0	32,00	0360	●	○	○	○
M39	4,00	200	-	40	-	32,0	24,0	35,00	0390	●	○	○	○
M42	4,50	200	-	45	-	32,0	24,0	37,50	0420	●	○	○	○
M45	4,50	220	-	45	-	36,0	29,0	40,50	0450	●	○	○	○
M48	5,00	250	-	50	-	36,0	29,0	43,00	0480	●	○	○	○
M52	5,00	250	-	50	-	40,0	32,0	47,00	0520	●	○	○	○

ISO	Vc (m/min)			
P	5-35	5-35	5-35	5-35
M	5-15	5-15	5-15	5-15
K	5-25	5-25	5-25	5-25
N	10-30	10-30	10-30	10-30
S	-	-	-	-

Gwint metryczny ISO DIN-13										800X							
										B	C-R40						
<div style="display: flex; justify-content: space-between;"> <div style="border: 1px solid black; padding: 2px;">HSSE</div> <div style="border: 1px solid black; padding: 2px;">TN2</div> <div style="border: 1px solid black; padding: 2px;">DIN 371-EL</div> <div style="border: 1px solid black; padding: 2px;">DIN 376-EL</div> </div>																	
Rodzaj materiału obrabianego										<div style="display: flex; justify-content: space-around;"> <div style="border: 1px solid black; padding: 2px;">P</div> <div style="border: 1px solid black; padding: 2px;">M</div> <div style="border: 1px solid black; padding: 2px;">K</div> </div> <div style="display: flex; justify-content: space-around; margin-top: 2px;"> <div style="border: 1px solid black; padding: 2px;">N</div> <div style="border: 1px solid black; padding: 2px;">S</div> <div style="border: 1px solid black; padding: 2px;">H</div> </div>		<div style="display: flex; justify-content: space-around;"> <div style="border: 1px solid black; padding: 2px;">P</div> <div style="border: 1px solid black; padding: 2px;">M</div> <div style="border: 1px solid black; padding: 2px;">K</div> </div> <div style="display: flex; justify-content: space-around; margin-top: 2px;"> <div style="border: 1px solid black; padding: 2px;">N</div> <div style="border: 1px solid black; padding: 2px;">S</div> <div style="border: 1px solid black; padding: 2px;">H</div> </div>					
Typ otworu																	
Rodzaj materiału										HSSE							
Rodzaj powłoki										TN2							
Nakrój										B / 4-5P		C / 2-3P					
M $\varnothing d_1$	P	l_1	l_2	l_2 R40	l_3	$\varnothing d_2$	a		Norma		DIN-371-EL						
									Tol.		ISO2 (6H)	ISO2 (6H)					
									INDEX		C2-113X21	C2-513X21					
M3	0,50	100	10	5	18	3,5	2,7	2,50	0030	●	●						
M3,5	0,60	100	12	6	20	4,0	3,0	2,90	0035	○	○						
M4	0,70	125	12	7	21	4,5	3,4	3,30	0040	●	●						
M5	0,80	140	14	8	25	6,0	4,9	4,20	0050	●	●						
M6	1,00	160	18	10	30	6,0	4,9	5,00	0060	●	●						

M $\varnothing d_1$	P	l_1	l_2	l_2 R40	l_3	$\varnothing d_2$	a		Norma		DIN-376-EL					
									Tol.		ISO2 (6H)					
									INDEX		D2-113X21	D2-513X21				
M8	1,25	180	20	15	-	6,0	4,9	6,80	0080	●	●					
M10	1,50	200	20	17	-	7,0	5,5	8,50	0100	●	●					
M12	1,75	220	24	18	-	9,0	7,0	10,20	0120	●	●					
M14	2,00	220	25	20	-	11,0	9,0	12,00	0140	○	○					
M16	2,00	220	32	20	-	12,0	9,0	14,00	0160	●	●					
M20	2,50	250	32	25	-	16,0	12,0	17,50	0200	○	○					

ISO	Vc (m/min)			
P	5-35	5-35		
M	5-15	5-15		
K	5-25	5-25		
N	10-30	10-30		
S	-	-		

Gwint metryczny ISO DIN-13										800									
										C	C-LH	B	B-LH	B	B				
Rodzaj materiału obrabianego										P M K	P M K	P M K	P M K	P M K	P M K				
Typ otworu																			
Rodzaj materiału										HSSE	HSSE	HSSE	HSSE	HSSE	HSSE				
Rodzaj powłoki																			
Nakrój										C / 2-3P	C / 2-3P	B / 4-5P	B / 4-5P	B / 4-5P	B / 4-5P				
M Ød ₁	P	l ₁	l ₂	l ₂ R40	l ₃	Ød ₂	a		Norma										
									DIN-371										
									Tol.	ISO1(4H)		ISO1(4H)				INDEX	C4-121102		C4-111102
M1	0,25	40	6	-	13	2,5	2,1	0,75	0010	●		●							
M1,1	0,25	40	6	-	13	2,5	2,1	0,85	0011	●		●							
M1,2	0,25	40	6	-	13	2,5	2,1	0,95	0012	●		●							
M1,4	0,30	40	7	-	13	2,5	2,1	1,10	0014	●		●							
M Ød ₁	P	l ₁	l ₂	l ₂ R40	l ₃	Ød ₂	a		Norma										
									DIN-371										
									Tol.	ISO2 (6H)		ISO2 (6H)				INDEX	C4-121101		C4-111101
M1,6	0,35	40	8	-	13	2,5	2,1	1,25	0016	●		●							
M1,7	0,35	40	8	-	13	2,5	2,1	1,35	0017	●		●							
M1,8	0,35	40	8	-	13	2,5	2,1	1,45	0018	●		●							
M2	0,40	45	10	-	13	2,8	2,1	1,60	0020	●		●							
M2,2	0,45	45	10	-	13	2,8	2,1	1,75	0022	●		●							
M2,3	0,40	45	10	-	13	2,8	2,1	1,90	0023	●		●							
M2,5	0,45	50	9	-	14	2,8	2,1	2,05	0025	●		●							
M2,6	0,45	50	9	-	14	2,8	2,1	2,15	0026	●		●							
M Ød ₁	P	l ₁	l ₂	l ₂ R40	l ₃	Ød ₂	a		Norma										
									DIN-371										
									Tol.	ISO2 (6H)	ISO2 (6H)	ISO2 (6H)	ISO2 (6H)	ISO3 (6G)	7G	INDEX	C2-121101	C2-221101	C2-111101
M3	0,50	56	10	-	18	3,5	2,7	2,50	0030	●	●	●	●	●	○				
M3,5	0,60	56	12	-	20	4,0	3,0	2,90	0035	●	○	●	○	○	○				
M4	0,70	63	12	-	21	4,5	3,4	3,30	0040	●	●	●	●	●	○				
M4,5	0,75	70	14	-	25	6,0	4,9	3,80	0045	●	○	●	○	○	○				
M5	0,80	70	14	-	25	6,0	4,9	4,20	0050	●	●	●	●	●	○				
M6	1,00	80	18	-	30	6,0	4,9	5,00	0060	●	●	●	●	●	○				
M7	1,00	80	18	-	30	7,0	5,5	6,00	0070	●	○	●	○	○	○				
M8	1,25	90	20	-	35	8,0	6,2	6,80	0080	●	●	●	●	●	○				
M9	1,25	90	20	-	35	9,0	7,0	7,80	0090	●	○	●	○	○	○				
M10	1,50	100	20	-	39	10,0	8,0	8,50	0100	●	●	●	●	●	○				
										ISO									
										Vc (m/min)									
										P	5-20	5-20	5-20	5-20	5-20	5-20			
										M	5-10	5-10	5-10	5-10	5-10	5-10			
										K	5-15	5-15	5-15	5-15	5-15	5-15			
										N	5-25	5-25	5-25	5-25	5-25	5-25			
										S	-	-	-	-	-	-			

● Dostępne z magazynu

○ Na zapytanie



Gwint metryczny ISO DIN-13										800						
										C	C-LH	B	B-LH	B	B	
Rodzaj materiału obrabianego																
Typ otworu																
Rodzaj materiału										HSSE	HSSE	HSSE	HSSE	HSSE	HSSE	
Rodzaj powłoki																
Nakrój										C / 2-3P	C / 2-3P	B / 4-5P	B / 4-5P	B / 4-5P	B / 4-5P	
M Ød ₁	P	l ₁	l ₂	l ₂ R40	l ₃	Ød ₂	a		Norm							
									DIN-376							
									Tol.	ISO2 (6H)	ISO2 (6H)	ISO2 (6H)	ISO2 (6H)	ISO3 (6G)	7G	
										INDEX	D2-121101	D2-221101	D2-111101	D2-211101	D2-111103	D2-111104
M3	0,50	56	11	-	-	2,2	1,8	2,50	0030	●	○	●	○	○	○	
M4	0,70	63	12	-	-	2,8	2,1	3,30	0040	●	○	●	○	○	○	
M5	0,80	70	14	-	-	3,5	2,7	4,20	0050	●	○	●	○	○	○	
M6	1,00	80	18	-	-	4,5	3,4	5,00	0060	●	○	●	○	○	○	
M8	1,25	90	20	-	-	6,0	4,9	6,80	0080	●	○	●	○	○	○	
M10	1,50	100	20	-	-	7,0	5,5	8,50	0100	●	○	●	○	○	○	
M12	1,75	110	24	-	-	9,0	7,0	10,20	0120	●	●	●	●	●	○	
M14	2,00	110	25	-	-	11,0	9,0	12,00	0140	●	○	●	○	○	○	
M16	2,00	110	32	-	-	12,0	9,0	14,00	0160	●	●	●	●	●	○	
M18	2,50	125	32	-	-	14,0	11,0	15,50	0180	●	○	●	○	○	○	
M20	2,50	140	32	-	-	16,0	12,0	17,50	0200	●	●	●	●	●	○	
M22	2,50	140	32	-	-	18,0	14,5	19,50	0220	●	○	●	○	○	○	
M24	3,00	160	38	-	-	18,0	14,5	21,00	0240	●	●	●	●	○	○	
M27	3,00	160	38	-	-	20,0	16,0	24,00	0270	●	○	●	○	○	○	
M30	3,50	180	45	-	-	22,0	18,0	26,50	0300	●	○	●	○	○	○	
M33	3,50	180	45	-	-	25,0	20,0	29,50	0330	●	○	●	○	○	○	
M36	4,00	200	50	-	-	28,0	22,0	32,00	0360	●	○	●	○	○	○	
M39	4,00	200	50	-	-	32,0	24,0	35,00	0390	●	○	●	○	○	○	
M42	4,50	200	60	-	-	32,0	24,0	37,50	0420	●	○	●	○	○	○	
M45	4,50	220	60	-	-	36,0	29,0	40,50	0450	●	○	●	○	○	○	
M48	5,00	250	65	-	-	36,0	29,0	43,00	0480	●	○	●	○	○	○	
M52	5,00	250	65	-	-	40,0	32,0	47,00	0520	●	○	●	○	○	○	
										V _c (m/min)						
ISO										P	5-35	5-20	5-20	5-20	5-20	5-20
ISO										M	5-10	5-10	5-10	5-10	5-10	5-10
ISO										K	10-25	5-15	5-15	5-15	5-15	5-15
ISO										N	10-35	5-25	5-25	5-25	5-25	5-25
ISO										S	-	-	-	-	-	-

1

Gwint metryczny ISO DIN-13										800							
										C-R40	C-LH-L40	C-R40	C-R40				
HSSE DIN 371																	
Rodzaj materiału obrabianego																	
Typ otworu																	
Rodzaj materiału																	
Rodzaj powłoki																	
Nakrój										C / 2-3P				C / 2-3P			
M Ød ₁	P	l ₁	l ₂	l ₂ R40	l ₃	Ød ₂	a		Norma	DIN-371							
									Tol.	ISO1(4H)							
									INDEX	C4-511102							
M1	0,25	40	-	6	13	2,5	2,1	0,75	0010	●							
M1,1	0,25	40	-	6	13	2,5	2,1	0,85	0011	●							
M1,2	0,25	40	-	6	13	2,5	2,1	0,95	0012	●							
M1,4	0,30	40	-	8	13	2,5	2,1	1,10	0014	●							
M Ød ₁	P	l ₁	l ₂	l ₂ R40	l ₃	Ød ₂	a		Norma	DIN-371							
									Tol.	ISO2 (6H)							
									INDEX	C4-511101							
M1,6	0,35	40	-	8	13	2,5	2,1	1,25	0016	●							
M1,7	0,35	40	-	8	13	2,5	2,1	1,35	0017	●							
M1,8	0,35	40	-	8	13	2,5	2,1	1,45	0018	●							
M2	0,40	45	-	10	13	2,8	2,1	1,60	0020	●							
M2,2	0,45	45	-	10	13	2,8	2,1	1,75	0022	●							
M2,3	0,40	45	-	10	13	2,8	2,1	1,90	0023	●							
M2,5	0,45	50	-	5	14	2,8	2,1	2,05	0025	●							
M2,6	0,45	50	-	5	14	2,8	2,1	2,15	0026	●							
M Ød ₁	P	l ₁	l ₂	l ₂ R40	l ₃	Ød ₂	a		Norma	DIN-371							
									Tol.	ISO2 (6H)	ISO2 (6H)	ISO3 (6G)	7G				
									INDEX	C2-511101	C2-591101	C2-511103	C2-511104				
M3	0,50	56	-	5	18	3,5	2,7	2,50	0030	●	●	●	○				
M3,5	0,60	56	-	6	20	4,0	3,0	2,90	0035	●	○	○	○				
M4	0,70	63	-	7	21	4,5	3,4	3,30	0040	●	●	●	○				
M4,5	0,75	70	-	7,5	25	6,0	4,9	3,80	0045	●	○	○	○				
M5	0,80	70	-	8	25	6,0	4,9	4,20	0050	●	●	●	○				
M6	1,00	80	-	10	30	6,0	4,9	5,00	0060	●	●	●	○				
M7	1,00	80	-	10	30	7,0	5,5	6,00	0070	●	○	○	○				
M8	1,25	90	-	13	35	8,0	6,2	6,80	0080	●	●	●	○				
M9	1,25	90	-	13	35	9,0	7,0	7,80	0090	●	○	○	○				
M10	1,50	100	-	15	39	10,0	8,0	8,50	0100	●	●	●	○				
										ISO				Vc (m/min)			
										P				5-20			
										M				5-10			
										K				5-15			
										N				5-25			
										S				-			

● Dostępne z magazynu

○ Na zapytanie



Gwint metryczny ISO DIN-13									800							
									C-R40	C-LH-L40	C-R40	C-R40				
Rodzaj materiału obrabianego																
Typ otworu																
Rodzaj materiału									HSSE							
Rodzaj powłoki																
Nakrój									C / 2-3P							
M $\varnothing d_1$	P	l_1	l_2	l_{R40}	l_3	$\varnothing d_2$	a		Norma DIN-376							
									Tol.	ISO2 (6H)	ISO2 (6H)	ISO3 (6G)	7G			
									INDEX	D2-511101	D2-591101	D2-511103	D2-511104			
M3	0,50	56	-	5	-	2,2	1,8	2,50	0030	●	○	○	○			
M4	0,70	63	-	8	-	2,8	2,1	3,30	0040	●	○	○	○			
M5	0,80	70	-	10	-	3,5	2,7	4,20	0050	●	○	○	○			
M6	1,00	80	-	12	-	4,5	3,4	5,00	0060	●	○	○	○			
M8	1,25	90	-	15	-	6,0	4,9	6,80	0080	●	○	○	○			
M10	1,50	100	-	17	-	7,0	5,5	8,50	0100	●	○	○	○			
M12	1,75	110	-	18	-	9,0	7,0	10,20	0120	●	●	●	○			
M14	2,00	110	-	20	-	11,0	9,0	12,00	0140	●	○	○	○			
M16	2,00	110	-	20	-	12,0	9,0	14,00	0160	●	●	●	○			
M18	2,50	125	-	25	-	14,0	11,0	15,50	0180	●	○	○	○			
M20	2,50	140	-	25	-	16,0	12,0	17,50	0200	●	●	●	○			
M22	2,50	140	-	25	-	18,0	14,5	19,50	0220	●	○	○	○			
M24	3,00	160	-	30	-	18,0	14,5	21,00	0240	●	●	○	○			
M27	3,00	160	-	30	-	20,0	16,0	24,00	0270	●	○	○	○			
M30	3,50	180	-	35	-	22,0	18,0	26,50	0300	●	○	○	○			
M33	3,50	180	-	35	-	25,0	20,0	29,50	0330	●	○	○	○			
M36	4,00	200	-	40	-	28,0	22,0	32,00	0360	●	○	○	○			
M39	4,00	200	-	40	-	32,0	24,0	35,00	0390	●	○	○	○			
M42	4,50	200	-	45	-	32,0	24,0	37,50	0420	●	○	○	○			
M45	4,50	220	-	45	-	36,0	29,0	40,50	0450	●	○	○	○			
M48	5,00	250	-	50	-	36,0	29,0	43,00	0480	●	○	○	○			
M52	5,00	250	-	50	-	40,0	32,0	47,00	0520	●	○	○	○			
									ISO				Vc (m/min)			
									P	5-20	5-20	5-20	5-20			
									M	5-10	5-10	5-10	5-10			
									K	5-15	5-15	5-15	5-15			
									N	5-25	5-25	5-25	5-25			
									S	-	-	-	-			

1

Gwint metryczny ISO DIN-13										800						
										B	C-R40					
HSSE DIN 371-EL DIN 376-EL																
Rodzaj materiału obrabianego																
Typ otworu																
Rodzaj materiału										HSSE						
Rodzaj powłoki																
Nakrój										B / 4-5P C / 2-3P						
M $\varnothing d_1$	P	l_1	l_2	l_2 R40	l_3	$\varnothing d_2$	a		Norma		DIN-371-EL					
									Tol.		ISO2 (6H)					
									INDEX		C2-111121	C2-511121				
M3	0,50	100	10	5	18	3,5	2,7	2,50	0030	●	●					
M3,5	0,60	100	12	6	20	4,0	3,0	2,90	0035	○	○					
M4	0,70	125	12	7	21	4,5	3,4	3,30	0040	●	●					
M5	0,80	140	14	8	25	6,0	4,9	4,20	0050	●	●					
M6	1,00	160	18	10	30	6,0	4,9	5,00	0060	●	●					

M $\varnothing d_1$	P	l_1	l_2	l_2 R40	l_3	$\varnothing d_2$	a		Norma		DIN-376-EL					
									Tol.		ISO2 (6H)					
									INDEX		D2-111121	D2-511121				
M8	1,25	180	20	15	-	6,0	4,9	6,80	0080	●	●					
M10	1,50	200	20	17	-	7,0	5,5	8,50	0100	●	●					
M12	1,75	220	24	18	-	9,0	7,0	10,20	0120	●	●					
M14	2,00	220	25	20	-	11,0	9,0	12,00	0140	○	○					
M16	2,00	220	32	20	-	12,0	9,0	14,00	0160	●	●					
M20	2,50	250	-	25	-	16,0	12,0	17,50	0200	○	○					

ISO	Vc (m/min)					
P	5-20	5-20				
M	5-10	5-10				
K	5-15	5-15				
N	5-25	5-25				
S	-	-				



Gwint metryczny ISO DIN-13										<i>FAN-1200</i>		<i>1400-HT</i>							
										B-TS	C-R40-TS	C-TS	B-TS	C-R15-TS					
Rodzaj materiału obrabianego																			
Typ otworu																			
Rodzaj materiału										HSSE-PM		HSSE-PM		HSSE-PM		HSSE-PM		HSSE-PM	
Rodzaj powłoki										TS		TS		TS		TS		TS	
Nakrój										B / 4-5P		C / 2-3P		C / 2-3P		B / 4-5P		C / 2-3P	
M $\varnothing d_1$	P	l_1	l_2	l_2 R40	l_3	$\varnothing d_2$	a		Norma										
									DIN-371										
										Tol.	ISO2 (6H)	ISO2 (6H)	6HX	6HX	6HX				
										INDEX	C4-115001	C4-565001	C4-12G901	C4-11G901	C4-50G901				
M 3	0,50	56	10	5	18	3,5	2,7	2,50	0030	●	●	●	●	●					
M 4	0,70	63	12	7	21	4,5	3,4	3,30	0040	●	●	●	●	●					
M 5	0,80	70	14	8	25	6,0	4,9	4,20	0050	●	●	●	●	●					
M 6	1,00	80	18	10	30	6,0	4,9	5,00	0060	●	●	●	●	●					
M 8	1,25	90	20	13	35	8,0	6,2	6,80	0080	●	●	●	●	●					
M10	1,50	100	20	15	39	10,0	8,0	8,50	0100	●	●	●	●	●					
M $\varnothing d_1$	P	l_1	l_2	l_2 R40	l_3	$\varnothing d_2$	a		Norma										
									DIN-376										
										Tol.	ISO2 (6H)	ISO2 (6H)	6HX	6HX	6HX				
										INDEX	D4-115001	D4-565001	D4-12G901	D4-11G901	D4-50G901				
M8	1,25	90	20	15	-	6,0	4,9	6,80	0080	●	●	●	●	●					
M10	1,50	100	20	17	-	7,0	5,5	8,50	0100	●	●	●	●	●					
M12	1,75	110	24	18	-	9,0	7,0	10,20	0120	●	●	●	●	●					
M14	2,00	110	25	20	-	11,0	9,0	12,00	0140	●	●	●	●	●					
M16	2,00	110	32	20	-	12,0	9,0	14,00	0160	●	●	●	●	●					
M18	2,50	125	32	25	-	14,0	11,0	15,50	0180	●	●	○	○	○					
M20	2,50	140	32	25	-	16,0	12,0	17,50	0200	●	●	●	●	●					
M22	2,50	140	32	25	-	18,0	14,5	19,50	0220	●	●	○	○	○					
M24	3,00	160	38	30	-	18,0	14,5	21,00	0240	●	●	●	●	●					
M27	3,00	160	38	30	-	20,0	16,0	24,00	0270	●	●	○	○	○					
M30	3,50	180	45	35	-	22,0	18,0	26,50	0300	●	●	○	○	○					
M33	3,50	180	45	35	-	25,0	20,0	29,50	0330	●	●	○	○	○					
M36	4,00	200	50	40	-	28,0	22,0	32,00	0360	●	●	○	○	○					
ISO										Vc (m/min)									
P										5-35	5-35	1-20	1-20	1-20					
M										5-15	5-10	1-10	1-10	1-10					
K										5-25	5-25	1-20	1-20	1-20					
N										10-30	10-30	10-20	10-20	10-20					
S										-	-	-	-	-					



Gwint metryczny ISO DIN-13									INOX																																						
									B	B-HL	C-R40	C-R40-HL																																			
Rodzaj materiału obrabianego									<table border="1"> <tr> <td>P</td><td>M</td><td>K</td><td></td> <td>P</td><td>M</td><td>K</td><td></td> <td>P</td><td>M</td><td>K</td><td></td> <td>P</td><td>M</td><td>K</td><td></td> </tr> <tr> <td>N</td><td>S</td><td>H</td><td></td> <td>N</td><td>S</td><td>H</td><td></td> <td>N</td><td>S</td><td>H</td><td></td> <td>N</td><td>S</td><td>H</td><td></td> </tr> </table>				P	M	K		P	M	K		P	M	K		P	M	K		N	S	H		N	S	H		N	S	H		N	S	H				
P	M	K		P	M	K		P	M	K		P	M	K																																	
N	S	H		N	S	H		N	S	H		N	S	H																																	
Typ otworu									<table border="1"> <tr> <td></td> <td></td> <td></td> <td></td> <td colspan="3"></td> </tr> <tr> <td><math>< 3d</math></td> <td><math>< 3d</math></td> <td><math>< 2.5d</math></td> <td><math>< 2.5d</math></td> <td colspan="3"></td> </tr> </table>											<math>< 3d</math>	<math>< 3d</math>	<math>< 2.5d</math>	<math>< 2.5d</math>																								
<math>< 3d</math>	<math>< 3d</math>	<math>< 2.5d</math>	<math>< 2.5d</math>																																												
Rodzaj materiału									HSSE																																						
Rodzaj powłoki									-				HL																																		
Nakrój									B / 4-5P				B / 4-5P																																		
									C / 2-3P				C / 2-3P																																		
M $\varnothing d_1$	P	l_1	l_2	l_{R40}	l_3	$\varnothing d_2$	a		Norma																																						
									DIN-376																																						
									Tol.	ISO2 (6H)	ISO2 (6H)	ISO2 (6H)	ISO2 (6H)																																		
									INDEX	D2-111801	D2-118801	D2-511801	D2-518801																																		
M8	1,25	90	20	15	-	6,0	4,9	6,80	0080	●	●	●	●																																		
M10	1,50	100	20	17	-	7,0	5,5	8,50	0100	●	●	●	●																																		
M12	1,75	110	24	18	-	9,0	7,0	10,20	0120	●	●	●	●																																		
M14	2,00	110	25	20	-	11,0	9,0	12,00	0140	●	●	●	●																																		
M16	2,00	110	32	20	-	12,0	9,0	14,00	0160	●	●	●	●																																		
M18	2,50	125	32	25	-	14,0	11,0	15,50	0180	●	●	●	●																																		
M20	2,50	140	32	25	-	16,0	12,0	17,50	0200	●	●	●	●																																		
M22	2,50	140	32	25	-	18,0	14,5	19,50	0220	●	●	●	●																																		
M24	3,00	160	38	30	-	18,0	14,5	21,00	0240	●	●	●	●																																		
M27	3,00	160	38	30	-	20,0	16,0	24,00	0270	●	○	●	○																																		
M30	3,50	180	45	35	-	22,0	18,0	26,50	0300	●	○	●	○																																		
M33	3,50	180	45	35	-	25,0	20,0	29,50	0330	●	○	●	○																																		
M36	4,00	200	50	40	-	28,0	22,0	32,00	0360	●	○	●	○																																		
									ISO																																						
									Vc (m/min)																																						
									P	-	-	-	-																																		
									M	5-15	5-15	5-15	5-15																																		
									K	-	-	-	-																																		
									N	-	-	-	-																																		
									S	-	-	-	-																																		

1

Gwint metryczny ISO DIN-13										GG					GAL																																																																																																																																																																															
										C-TS	C-IK-TS	E-TS	E-IK-TS	E-IKR-TS	C-R15-TS	E-R15-IK-TS																																																																																																																																																																														
Rodzaj materiału obrabianego	Typ otworu	Rodzaj materiału	Rodzaj powłoki	Nakrój																																																																																																																																																																																										
<table border="1"> <thead> <tr> <th rowspan="3">M Ød₁</th> <th rowspan="3">P</th> <th rowspan="3">l₁</th> <th rowspan="3">l₂</th> <th rowspan="3">l₃</th> <th rowspan="3">Ød₂</th> <th rowspan="3">a</th> <th rowspan="3"> </th> <th colspan="7">Norma</th> </tr> <tr> <th colspan="7">DIN-371</th> </tr> <tr> <th>Tol.</th> <th>6HX</th> <th>6HX</th> <th>6HX</th> <th>6HX</th> <th>6HX</th> <th>6HX</th> <th>6HX</th> </tr> <tr> <th colspan="9">INDEX</th> <th>C2-125501</th> <th>C4-125551</th> <th>C2-145501</th> <th>C4-145551</th> <th>C4-145561</th> <th>C2-505601</th> <th>C4-655651</th> </tr> </thead> <tbody> <tr><td>M 3</td><td>0,50</td><td>56</td><td>10</td><td>18</td><td>3,5</td><td>2,7</td><td>2,50</td><td>0030</td><td>●</td><td>-</td><td>○</td><td>-</td><td>-</td><td>●</td><td>-</td></tr> <tr><td>M 4</td><td>0,70</td><td>63</td><td>12</td><td>21</td><td>4,5</td><td>3,4</td><td>3,30</td><td>0040</td><td>●</td><td>-</td><td>●</td><td>-</td><td>-</td><td>●</td><td>-</td></tr> <tr><td>M 5</td><td>0,80</td><td>70</td><td>14</td><td>25</td><td>6,0</td><td>4,9</td><td>4,20</td><td>0050</td><td>●</td><td>●</td><td>●</td><td>●</td><td>●</td><td>●</td><td>○</td></tr> <tr><td>M 6</td><td>1,00</td><td>80</td><td>18</td><td>30</td><td>6,0</td><td>4,9</td><td>5,00</td><td>0060</td><td>●</td><td>●</td><td>●</td><td>●</td><td>●</td><td>●</td><td>○</td></tr> <tr><td>M 7</td><td>1,00</td><td>80</td><td>18</td><td>30</td><td>7,0</td><td>5,5</td><td>6,00</td><td>0070</td><td>○</td><td>○</td><td>○</td><td>○</td><td>○</td><td>○</td><td>○</td></tr> <tr><td>M 8</td><td>1,25</td><td>90</td><td>20</td><td>35</td><td>8,0</td><td>6,2</td><td>6,80</td><td>0080</td><td>●</td><td>●</td><td>●</td><td>●</td><td>●</td><td>●</td><td>○</td></tr> <tr><td>M 9</td><td>1,25</td><td>90</td><td>20</td><td>35</td><td>9,0</td><td>7,0</td><td>7,80</td><td>0090</td><td>○</td><td>○</td><td>○</td><td>○</td><td>○</td><td>○</td><td>○</td></tr> <tr><td>M10</td><td>1,50</td><td>100</td><td>20</td><td>39</td><td>10,0</td><td>8,0</td><td>8,50</td><td>0100</td><td>●</td><td>●</td><td>●</td><td>●</td><td>●</td><td>●</td><td>○</td></tr> </tbody> </table>										M Ød ₁	P	l ₁	l ₂	l ₃	Ød ₂	a		Norma							DIN-371							Tol.	6HX	6HX	6HX	6HX	6HX	6HX	6HX	INDEX									C2-125501	C4-125551	C2-145501	C4-145551	C4-145561	C2-505601	C4-655651	M 3	0,50	56	10	18	3,5	2,7	2,50	0030	●	-	○	-	-	●	-	M 4	0,70	63	12	21	4,5	3,4	3,30	0040	●	-	●	-	-	●	-	M 5	0,80	70	14	25	6,0	4,9	4,20	0050	●	●	●	●	●	●	○	M 6	1,00	80	18	30	6,0	4,9	5,00	0060	●	●	●	●	●	●	○	M 7	1,00	80	18	30	7,0	5,5	6,00	0070	○	○	○	○	○	○	○	M 8	1,25	90	20	35	8,0	6,2	6,80	0080	●	●	●	●	●	●	○	M 9	1,25	90	20	35	9,0	7,0	7,80	0090	○	○	○	○	○	○	○	M10	1,50	100	20	39	10,0	8,0	8,50	0100	●	●	●	●	●	●	○	HSSE-PM	HSSE-PM	HSSE-PM	HSSE-PM	HSSE-PM	HSSE-PM	HSSE-PM
M Ød ₁	P	l ₁	l ₂	l ₃	Ød ₂	a		Norma																																																																																																																																																																																						
								DIN-371																																																																																																																																																																																						
								Tol.	6HX	6HX	6HX	6HX	6HX	6HX	6HX																																																																																																																																																																															
INDEX									C2-125501	C4-125551	C2-145501	C4-145551	C4-145561	C2-505601	C4-655651																																																																																																																																																																															
M 3	0,50	56	10	18	3,5	2,7	2,50	0030	●	-	○	-	-	●	-																																																																																																																																																																															
M 4	0,70	63	12	21	4,5	3,4	3,30	0040	●	-	●	-	-	●	-																																																																																																																																																																															
M 5	0,80	70	14	25	6,0	4,9	4,20	0050	●	●	●	●	●	●	○																																																																																																																																																																															
M 6	1,00	80	18	30	6,0	4,9	5,00	0060	●	●	●	●	●	●	○																																																																																																																																																																															
M 7	1,00	80	18	30	7,0	5,5	6,00	0070	○	○	○	○	○	○	○																																																																																																																																																																															
M 8	1,25	90	20	35	8,0	6,2	6,80	0080	●	●	●	●	●	●	○																																																																																																																																																																															
M 9	1,25	90	20	35	9,0	7,0	7,80	0090	○	○	○	○	○	○	○																																																																																																																																																																															
M10	1,50	100	20	39	10,0	8,0	8,50	0100	●	●	●	●	●	●	○																																																																																																																																																																															
										TS	TS	TS	TS	TS	TS	TS																																																																																																																																																																														
										C / 2-3P	C / 2-3P	E / 1,5-2P	E / 1,5-2P	E / 1,5-2P	C / 2-3P	E / 1,5-2P																																																																																																																																																																														
										DIN-371																																																																																																																																																																																				
										Tol.	6HX	6HX	6HX	6HX	6HX	6HX	6HX																																																																																																																																																																													
										INDEX	C2-125501	C4-125551	C2-145501	C4-145551	C4-145561	C2-505601	C4-655651																																																																																																																																																																													
										M6	1,00	80	18	-	4,5	3,4	5,00	0060	●	○	●	○	○	○																																																																																																																																																																						
										M8	1,25	90	20	-	6,0	4,9	6,80	0080	●	●	●	●	○	○	○																																																																																																																																																																					
										M10	1,50	100	20	-	7,0	5,5	8,50	0100	●	●	●	●	○	○	○																																																																																																																																																																					
										M12	1,75	110	24	-	9,0	7,0	10,20	0120	●	●	●	●	●	●	●	●																																																																																																																																																																				
										M14	2,00	110	25	-	11,0	9,0	12,00	0140	●	○	○	○	○	○	○	○																																																																																																																																																																				
										M16	2,00	110	32	-	12,0	9,0	14,00	0160	●	●	○	●	●	●	●	●	●																																																																																																																																																																			
										M18	2,50	125	32	-	14,0	11,0	15,50	0180	●	○	○	○	○	○	○	○	○																																																																																																																																																																			
										M20	2,50	140	32	-	16,0	12,0	17,50	0200	●	○	○	○	○	○	○	○	○																																																																																																																																																																			
										ISO	Vc (m/min)																																																																																																																																																																																			
										P	-	-	-	-	-	-	-	-	-	-	-	-																																																																																																																																																																								
										M	-	-	-	-	-	-	-	-	-	-	-	-	-																																																																																																																																																																							
										K	1-60	5-60	1-60	5-60	5-60	-	-	-	-	-	-	-																																																																																																																																																																								
										N	-	-	-	-	-	-	-	-	-	10-30	10-30	-	-																																																																																																																																																																							
										S	-	-	-	-	-	-	-	-	-	-	-	-	-	-																																																																																																																																																																						



Gwint metryczny ISO DIN-13									HRC60							
									C-HM-TC	C-1K-HM-TC	D-HM-TC	D-1K-HM-TC				
Rodzaj materiału obrabianego																
Typ otworu																
Rodzaj materiału									VHM		VHM		VHM		VHM	
Rodzaj powłoki									TC		TC		TC		TC	
Nakrój									C / 2-3P		C / 2-3P		D / 4-5P		D / 4-5P	
M Ød ₁	P	l ₁	l ₂	l ₃	Ød ₂	a		Norma								
								DIN-371								
								Tol. 6HX								
INDEX								C9-125F01	C9-125F51	C9-135F01	C9-135F51					
M3	0,50	56	5	18	3,5	2,7	2,50	0030	●	-	●	-				
M4	0,70	63	7	21	4,5	3,4	3,30	0040	●	-	●	-				
M5	0,80	70	8	25	6,0	4,9	4,20	0050	●	-	●	-				
M6	1,00	80	10	30	6,0	4,9	5,00	0060	●	●	●	●				
M8	1,25	90	13	35	8,0	6,2	6,80	0080	●	●	●	●				
M10	1,50	100	15	39	10,0	8,0	8,50	0100	●	●	●	●				
M Ød ₁	P	l ₁	l ₂	l ₃	Ød ₂	a		Norma								
								DIN-376								
								Tol. 6HX								
INDEX								D9-125F01	D9-125F51	D9-135F01	D9-135F51					
M12	1,75	110	18	-	9,0	7,0	10,20	0120	●	●	●	●				
M14	2,00	110	20	-	11,0	9,0	12,00	0140	●	●	●	●				
M16	2,00	110	20	-	12,0	9,0	14,00	0160	●	●	●	●				
ISO								Vc (m/min)								
P								-	-	-	-					
M								-	-	-	-					
K								-	-	-	-					
N								-	-	-	-					
S								-	-	-	-					
H								1-4	1-4	1-4	1-4					

1

Gwint metryczny ISO DIN-13										S-NC						
										B-TC	C-R45-TC	C-R45-IK-TC				
Rodzaj materiału obrabianego																
Typ otworu																
Rodzaj materiału										HSSE-PM						
Rodzaj powłoki										TC						
Nakrój										B / 4-5P						
										C / 2-3P						
										C / 2-3P						
Norma										DIN-371						
M	P	l ₁	l ₂	l ₃	Ød ₂	a		Tol.	6HX	6HX	6HX					
Ød ₁								INDEX	C4-115301	C4-525301	C4-525351					
M3	0,50	56	5	18	3,5	2,7	2,50	0030	●	●	-					
M4	0,70	63	7	21	4,5	3,4	3,30	0040	●	●	-					
M5	0,80	70	8	25	6,0	4,9	4,20	0050	●	●	●					
M6	1,00	80	10	30	6,0	4,9	5,00	0060	●	●	●					
M8	1,25	90	13	35	8,0	6,2	6,80	0080	●	●	●					
M10	1,50	100	15	39	10,0	8,0	8,50	0100	●	●	●					
Norma										DIN-376						
M	P	l ₁	l ₂	l ₃	Ød ₂	a		Tol.	6HX	6HX	6HX					
Ød ₁								INDEX	D4-115301	D4-525301	D4-525351					
M12	1,75	110	18	-	9,0	7,0	10,20	0120	●	●	●					
M14	2,00	110	20	-	11,0	9,0	12,00	0140	●	●	●					
M16	2,00	110	20	-	12,0	9,0	14,00	0160	●	●	●					
ISO										V _c (m/min)						
P										5-50						
M										5-20						
K										10-40						
N										10-40						
S										1-8						



Gwint metryczny ISO DIN-13									LH							
HSS DIN 352									P M K N S H							
Rodzaj materiału obrabianego									P M K N S H							
Typ otworu																
Rodzaj materiału									HSS							
Rodzaj powłoki																
Nakrój									~3P							
M $\varnothing d_1$	P	l_1	l_2	l_3	$\varnothing d_2$	a		Norma		DIN-352						
								Tol.	ISO2 (6H)	ISO2 (6H)						
								INDEX	E1-131001	E1-231001						
M3	0,50	40	11	18,0	3,5	2,7	2,5	0030	●	○						
M3,5	0,60	45	13	21,0	4,0	3,0	2,9	0035	●	○						
M4	0,70	45	13	21,0	4,5	3,4	3,3	0040	●	○						
M4,5	0,75	50	16	25,0	6,0	4,9	3,7	0045	○	○						
M5	0,80	52	16	26,0	6,0	4,9	4,2	0050	●	○						
M6	1,00	56	18	27,0	6,0	4,9	5,0	0060	●	○						
M7	1,00	56	18	-	6,0	4,9	6,0	0070	○	○						
M8	1,25	63	20	-	6,0	4,9	6,8	0080	●	○						
M9	1,25	63	20	-	7,0	5,5	7,8	0090	○	○						
M10	1,50	70	22	-	7,0	5,5	8,5	0100	●	○						
M11	1,50	70	22	-	8,0	6,2	9,5	0110	○	○						
M12	1,75	80	24	-	9,0	7,0	10,2	0120	●	○						
M14	2,00	80	26	-	11,0	9,0	12,0	0140	●	○						
M16	2,00	80	27	-	12,0	9,0	14,0	0160	●	○						
M18	2,50	95	30	-	14,0	11,0	15,5	0180	●	○						
M20	2,50	95	32	-	16,0	12,0	17,5	0200	●	○						
M22	2,50	100	32	-	18,0	14,5	19,5	0220	●	○						
M24	3,00	110	34	-	18,0	14,5	21,0	0240	●	○						
M27	3,00	110	36	-	20,0	16,0	24,0	0270	●	○						
M30	3,50	125	40	-	22,0	18,0	26,5	0300	●	○						
M33	3,50	125	40	-	25,0	20,0	29,5	0330	○	○						
M36	4,00	150	50	-	28,0	22,0	32,0	0360	●	○						
M39	4,00	150	50	-	32,0	24,0	35,0	0390	○	○						
M42	4,50	150	56	-	32,0	24,0	37,5	0420	●	○						
M45	4,50	160	58	-	36,0	29,0	40,5	0450	○	○						
M48	5,00	180	65	-	36,0	29,0	43,0	0480	○	○						
M52	5,00	180	65	-	40,0	32,0	47,0	0520	○	○						
M56	5,50	180	70	-	40,0	32,0	50,5	0560	○	○						
M60	5,50	200	70	-	45,0	35,0	54,5	0600	○	○						
M64	6,00	220	75	-	50,0	39,0	58,0	0640	○	○						
M68	6,00	220	75	-	50,0	39,0	62,0	0680	○	○						

- Dostępne z magazynu
- Na zapytanie

ISO	Vc (m/min)					
P	5-20	5-20				
M	-	-				
K	-	-				
N	-	-				
S	-	-				

Przykład zamówienia
E1-131001-0060
Gwintownik M6-6H DIN-352 HSS

1

Gwint metryczny ISO DIN-13				NUT-TAP					
				lutowane	skręcane				
 <div style="border: 1px solid black; padding: 2px; display: inline-block;">HSSE</div> <div style="border: 1px solid black; padding: 2px; display: inline-block; background-color: #8B4513; color: white;">TS</div>									
Rodzaj materiału obrabianego				<div style="display: flex; gap: 5px;"> <div style="border: 1px solid black; padding: 1px;">P</div> <div style="border: 1px solid black; padding: 1px;">M</div> <div style="border: 1px solid black; padding: 1px;">K</div> </div> <div style="display: flex; gap: 5px;"> <div style="border: 1px solid black; padding: 1px;">N</div> <div style="border: 1px solid black; padding: 1px;">S</div> <div style="border: 1px solid black; padding: 1px;">H</div> </div>	<div style="display: flex; gap: 5px;"> <div style="border: 1px solid black; padding: 1px;">P</div> <div style="border: 1px solid black; padding: 1px;">M</div> <div style="border: 1px solid black; padding: 1px;">K</div> </div> <div style="display: flex; gap: 5px;"> <div style="border: 1px solid black; padding: 1px;">N</div> <div style="border: 1px solid black; padding: 1px;">S</div> <div style="border: 1px solid black; padding: 1px;">H</div> </div>				
Typ otworu				 <math>< 1,5d</math>	 <math>< 1,5d</math>				
Rodzaj materiału				HSSE	HSSE				
Rodzaj powłoki				TS	TS				
Nakrój				12P	12P				
M	P	Wymiary gabarytowe		Na zapytanie					
M12	1,75	Na zapytanie	10,2	○	○				
M14	2,00		12,0	○	○				
M16	2,00		14,0	○	○				
M18	2,50		15,5	○	○				
M20	2,50		17,5	○	○				
M22	2,50		19,5	○	○				
M24	3,00		21,0	○	○				
M27	3,00		24,0	○	○				
M30	3,50		26,5	○	○				
M33	3,50		29,5	○	○				
M36	4,00		32,0	○	○				
ISO	Vc (m/min)								
P	5-20	5-20							
M	-	-							
K	-	-							
N	-	-							
S	-	-							









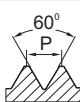

Gwint metryczny ISO DIN-13							NGMf																			
							LH																			
Rodzaj materiału obrabianego							<table border="1"> <tr><td>P</td><td>M</td><td>K</td></tr> <tr><td>N</td><td>S</td><td>H</td></tr> </table>	P	M	K	N	S	H	<table border="1"> <tr><td>P</td><td>M</td><td>K</td></tr> <tr><td>N</td><td>S</td><td>H</td></tr> </table>	P	M	K	N	S	H						
P	M	K																								
N	S	H																								
P	M	K																								
N	S	H																								
Typ otworu																										
Rodzaj materiału							HSS	HSS																		
Rodzaj powłoki																										
Nakrój							12P	12P																		
M Ød ₁	P	l ₁	l ₂	Ød ₂	a		Norma		NGMf																	
							Tol.	ISO2 (6H)	ISO2 (6H)																	
							INDEX	F1-151001	F1-251001																	
M3	0,5	70	10	2,24	1,8	2,50	0030	○	○																	
M4	0,70	90	14	2,8	2,24	3,30	0040	●	●																	
M4,5	0,75	100	16	3,15	2,5	3,80	0045	○	○																	
M5	0,80	110	16	3,55	2,8	4,20	0050	●	●																	
M6	1,00	120	20	4,5	3,55	5,00	0060	●	●																	
M7	1,00	120	20	5,6	4,5	6,00	0070	○	○																	
M8	1,25	140	25	6,3	5,0	6,80	0080	●	●																	
M10	1,50	160	30	8,0	6,3	8,50	0100	●	●																	
M12	1,75	180	36	9,0	7,1	10,20	0120	●	●																	
M14	2,00	180	40	10,0	8,0	12,00	0140	●	○																	
M16	2,00	200	40	12,5	10,0	14,00	0160	●	●																	
M18	2,50	200	50	14,0	11,2	15,50	0180	●	○																	
M20	2,50	220	50	16,0	12,5	17,50	0200	●	●																	
M22	2,50	220	50	18,0	14,0	19,50	0220	●	○																	
M24	3,00	250	60	18,0	14,0	21,00	0240	●	●																	
M27	3,00	250	60	20,0	16,0	24,00	0270	●	○																	
M30	3,50	280	70	22,4	18,0	26,50	0300	●	●																	
M33	3,50	280	70	25,0	20,0	29,50	0330	●	●																	
M36	4,00	320	80	28,0	22,4	32,00	0360	●	●																	
							Vc (m/min)																			
							P	5-20	5-20																	
							M	-	-																	
							K	6-15	6-15																	
							N	6-15	6-15																	
							S	-	-																	

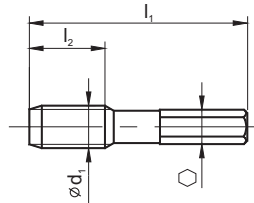
1

Gwint metryczny ISO DIN-13									KOMBI																												
 									D-R30																												
									Rodzaj materiału obrabianego									<table border="1"> <tr> <td>P</td> <td>M</td> <td>K</td> <td></td> <td></td> <td></td> <td></td> <td></td> </tr> <tr> <td>N</td> <td>S</td> <td>H</td> <td></td> <td></td> <td></td> <td></td> <td></td> </tr> </table>							P	M	K						N	S	H		
P	M	K																																			
N	S	H																																			
Typ otworu									 $$\varnothing$ <math>< 1,5d_1</math> $																												
Rodzaj materiału									HSS																												
Rodzaj powłoki									-																												
Nakrój									D/4P																												
M $\varnothing d_1$	P	l_1	l_2	l_3	$\varnothing d_2$	a		Norma																													
								KOMBI																													
								Tol. ISO2 (6H)																													
									INDEX		G1-051001																										
M 3	0,50	56	11	16	3	2,4	2,5	0030	●																												
M 4	0,70	63	14	18	4	3,0	3,3	0040	●																												
M 5	0,80	71	18	20	5	3,8	4,2	0050	●																												
M 6	1,00	80	22	22	6	4,9	5,0	0060	●																												
M 8	1,25	95	25	26	8	6,2	6,8	0080	●																												
M 10	1,50	106	31	30	10	8,0	8,5	0100	●																												
M 12	1,75	115	35	32	12	9,0	10,2	0120	●																												
									ISO		Vc (m/min)																										
									P	5-15																											
									M	-																											
									K	-																											
									N	6-15																											
									S	-																											



Gwint metryczny ISO DIN-13								BIT									
  								D									
																	
Rodzaj materiału obrabianego																	
Typ otworu																	
Rodzaj materiału								HSS									
Rodzaj powłoki								-									
Nakrój								D/4P									
M	P	l_1	l_2	l_3	ϕd_2			Norma	BIT								
ϕd_1								Tol.	ISO2 (6H)								
								INDEX	G1-031001								
M3	0,50	33	11	-	-	1/4"	2,5	0030	●								
M4	0,70	35	12	-	-	1/4"	3,3	0040	●								
M5	0,80	36	15	-	-	1/4"	4,2	0050	●								
M6	1,00	39	18	-	-	1/4"	5,0	0060	●								
M8	1,25	40	19	-	-	1/4"	6,8	0080	●								
M10	1,50	41	21	-	-	1/4"	8,5	0100	●								
ISO								Vc (m/min)									
P								5-15									
M								-									
K								-									
N								6-15									
S								-									



Zestaw BIT na str. 256



1

MASTER TAP

Gwint metryczny drobnozwojny ISO DIN-13									MASTER TAP						
									B-HL	B-IKR-HL	C-R45-HL	C-R45-IK-HL	E-R45-HL	E-R45-IK-HL	
<div style="display: flex; flex-direction: column; align-items: flex-start;"> <div style="border: 1px solid black; padding: 2px; margin-bottom: 5px;">HSSE PM</div> <div style="border: 1px solid black; padding: 2px; margin-bottom: 5px;">HL</div> <div style="border: 1px solid black; padding: 2px;">DIN 371</div> </div>									<div style="display: flex; justify-content: space-around;"> <div style="text-align: center;"></div> <div style="text-align: center;"></div> <div style="text-align: center;"></div> <div style="text-align: center;"></div> <div style="text-align: center;"></div> <div style="text-align: center;"></div> </div>						
Rodzaj materiału obrabianego															
Typ otworu									<div style="display: flex; justify-content: space-around;"> <div style="text-align: center;"></div> <div style="text-align: center;"></div> <div style="text-align: center;"></div> <div style="text-align: center;"></div> <div style="text-align: center;"></div> <div style="text-align: center;"></div> </div>						
Rodzaj materiału									HSSE-PM HSSE-PM HSSE-PM HSSE-PM HSSE-PM HSSE-PM						
Rodzaj powłoki									HL HL HL HL HL HL						
Nakrój									B / 4-5P B / 4-5P C / 2-3P C / 2-3P E / 1,5-2P E / 1,5-2P						
MF $\varnothing d_1$	P	l_1	l_2	l_3	$\varnothing d_2$	a		Norma	DIN-371						
									Tol.	6HX	6HX	6HX	6HX	6HX	6HX
									INDEX	C4-118M01	C4-118M61	C4-528M01	C4-528M51	C4-718M01	C4-718M51
M3x0,35	0,35	56	5	18	3,5	2,7	2,65	0031	●	-	●	-	○	-	
M3,5x0,35	0,35	56	5	20	4,0	3,0	3,15	0036	●	-	●	-	○	-	
M4x0,5	0,50	63	7	21	4,5	3,4	3,50	0041	●	-	●	-	○	-	
M5x0,5	0,50	70	8	25	6,0	4,9	4,50	0051	●	○	●	○	○	○	
M6x0,5	0,50	80	10	30	6,0	4,9	5,50	0061	●	○	●	○	○	○	
M6x0,75	0,75	80	10	30	6,0	4,9	5,20	0062	●	○	●	○	○	○	
M8x0,75	0,75	80	10	30	8,0	6,2	7,20	0082	●	○	●	○	○	○	
M8x1	1,00	90	13	35	8,0	6,2	7,00	0083	●	●	●	●	●	●	
M10x0,75	0,75	90	13	35	10,0	8,0	9,20	0102	●	○	●	○	○	○	
M10x1	1,00	90	13	35	10,0	8,0	9,00	0103	●	●	●	●	●	●	
M10x1,25	1,25	100	15	39	10,0	8,0	8,80	0104	●	○	●	○	○	○	
									Vc (m/min)						
									ISO	5-40	5-50	5-40	5-50	5-40	5-50
									P	5-40	5-50	5-40	5-50	5-40	5-50
									M	5-15	5-25	5-15	5-25	5-15	5-25
									K	10-30	10-50	10-30	10-50	10-30	10-50
									N	10-30	10-50	10-30	10-50	10-30	10-50
									S	1-8	1-8	1-8	1-8	1-8	1-8

Gwint metryczny drobnozwojny ISO DIN-13								MASTER TAP						
								B-HL	B-IKR-HL	C-R45-HL	C-R45-IK-HL	E-R45-HL	E-R45-IK-HL	
Rodzaj materiału obrabianego														
Typ otworu														
Rodzaj materiału								HSSE-PM HSSE-PM HSSE-PM HSSE-PM HSSE-PM HSSE-PM						
Rodzaj powłoki								HL HL HL HL HL HL						
Nakrój								B / 4-5P B / 4-5P C / 2-3P C / 2-3P E / 1,5-2P E / 1,5-2P						
MF Ø _{d1}	P	l ₁	l ₂	l ₃	Ø _{d2}	a		Norma						
								DIN-374						
								Tol.	6HX	6HX	6HX	6HX	6HX	6HX
								INDEX	D4-118M01	D4-118M61	D4-528M01	D4-528M51	D4-718M01	D4-718M51
M8x1	1,00	90	10	-	6,0	4,9	7,00	0083	●	●	●	●	●	○
M10x0,75	0,75	90	10	-	7,0	5,5	9,20	0102	○	○	○	○	○	○
M10x1	1,00	90	10	-	7,0	5,5	9,00	0103	●	●	●	●	●	○
M10x1,25	1,25	100	15	-	7,0	5,5	8,80	0104	○	○	○	○	○	○
M12x1	1,00	100	10	-	9,0	7,0	11,00	0123	●	○	●	○	○	○
M12x1,25	1,25	100	15	-	9,0	7,0	10,80	0124	●	○	●	○	○	○
M12x1,5	1,50	100	15	-	9,0	7,0	10,50	0125	●	●	●	●	●	○
M14x1	1,00	100	10	-	11,0	9,0	13,00	0143	○	○	○	○	○	○
M14x1,25	1,25	100	15	-	11,0	9,0	12,80	0144	○	○	○	○	○	○
M14x1,5	1,50	100	15	-	11,0	9,0	12,50	0145	●	●	●	●	●	○
M15x1	1,00	100	10	-	12,0	9,0	14,00	0153	○	○	○	○	○	○
M16x1	1,00	100	10	-	12,0	9,0	15,00	0163	○	○	○	○	○	○
M16x1,5	1,50	100	15	-	12,0	9,0	14,50	0165	●	●	●	●	●	○
M18x1	1,00	110	13	-	14,0	11,0	17,00	0183	○	○	○	○	○	○
M18x1,5	1,50	110	17	-	14,0	11,0	16,50	0185	●	○	●	○	○	○
M18x2	2,00	125	20	-	14,0	11,0	16,00	0186	○	○	○	○	○	○
M20x1	1,00	125	13	-	16,0	12,0	19,00	0203	○	○	○	○	○	○
M20x1,5	1,50	125	17	-	16,0	12,0	18,50	0205	●	○	●	○	○	○
M20x2	2,00	140	20	-	16,0	12,0	18,00	0206	○	○	○	○	○	○
M22x1	1,00	125	13	-	18,0	14,5	21,00	0223	○	○	○	○	○	○
M22x1,5	1,50	125	17	-	18,0	14,5	20,50	0225	●	○	●	○	○	○
M22x2	2,00	140	20	-	18,0	14,5	20,00	0226	○	○	○	○	○	○
M24x1	1,00	140	13	-	18,0	14,5	23,00	0243	○	○	○	○	○	○
M24x1,5	1,50	140	20	-	18,0	14,5	22,50	0245	●	○	●	○	○	○
M24x2	2,00	140	20	-	18,0	14,5	22,00	0246	○	○	○	○	○	○
								Vc (m/min)						
								P	5-40	5-50	5-40	5-50	5-40	5-50
								M	5-15	5-25	5-15	5-25	5-15	5-25
								K	10-30	10-50	10-30	10-50	10-30	10-50
								N	10-30	10-50	10-30	10-50	10-30	10-50
								S	1-8	1-8	1-8	1-8	1-8	1-8



MASTER TAP

1

**Gwint metryczny drobnozwojny
ISO DIN-13**

HSSE

TN2

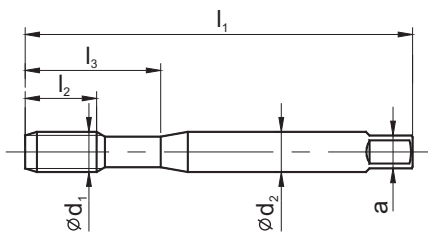
DIN
371**800X**

C-TN2

B-TN2

C-R40-TN2



Rodzaj materiału obrabianego

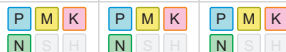

Typ otworu

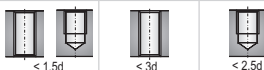

Rodzaj materiału

HSSE

HSSE

HSSE

Rodzaj powłoki

TN2

TN2

TN2

Nakrój

C / 2-3P

B / 4-5P

C / 2-3P

MF ød ₁	P	l ₁	l ₂	l ₂ R40	l ₃	ød ₂	a		Norma							
									DIN-371							
									Tol.	ISO2 (6H)	ISO2 (6H)					ISO2 (6H)
									INDEX	C2-123X01	C2-113X01	C2-513X01				
M4x0,5	0,50	63	12	7	21	4,5	3,4	3,50	0041	○	○	○				
M5x0,5	0,50	70	14	8	25	6,0	4,9	4,50	0051	○	○	○				
M6x0,75	0,75	80	14	10	30	6,0	4,9	5,20	0062	○	○	○				
M8x0,75	0,75	80	18	10	30	8,0	6,2	7,20	0082	○	○	○				
M8x1	1,00	90	20	13	35	8,0	6,2	7,00	0083	●	●	●				
M10x0,75	0,75	90	20	13	35	10,0	8,0	9,20	0102	○	○	○				
M10x1	1,00	90	20	13	35	10,0	8,0	9,00	0103	●	●	●				
M10x1,25	1,25	100	20	15	39	10,0	8,0	8,80	0104	○	●	●				

ISO	V _c (m/min)					
P	5-35	5-35	5-35			
M	5-15	5-15	5-15			
K	5-25	5-25	5-25			
N	10-30	10-30	10-30			
S	-	-	-			

800X



Gwint metryczny drobnozwojny ISO DIN-13										800X								
										C-TN2	B-TN2	C-R40-TN2						
Rodzaj materiału obrabianego																		
Typ otworu																		
Rodzaj materiału										HSSE	HSSE	HSSE						
Rodzaj powłoki										TN2	TN2	TN2						
Nakrój										C / 2-3P	B / 4-5P	C / 2-3P						
MF Ød ₁	P	l ₁	l ₂	l ₂ R40	l ₃	Ød ₂	a		Norma			DIN-374						
									ISO2 (6H)	ISO2 (6H)	ISO2 (6H)	ISO2 (6H)	ISO2 (6H)	ISO2 (6H)	ISO2 (6H)			
									INDEX	D2-123X01	D2-113X01	D2-513X01						
M8x1	1,00	90	20	10	-	6,0	4,9	7,00	0083	●	●	●						
M9x1	1,00	90	20	10	-	7,0	5,5	8,00	0093	○	○	○						
M10x0,75	0,75	90	18	10	-	7,0	5,5	9,20	0102	●	●	●						
M10x1	1,00	90	20	10	-	7,0	5,5	9,00	0103	●	●	●						
M10x1,25	1,25	100	20	15	-	7,0	5,5	8,80	0104	●	●	●						
M11x1	1,00	90	20	10	-	8,0	6,2	10,00	0113	○	○	○						
M12x1	1,00	100	20	10	-	9,0	7,0	11,00	0123	●	●	●						
M12x1,25	1,25	100	20	15	-	9,0	7,0	10,80	0124	●	●	●						
M12x1,5	1,50	100	20	15	-	9,0	7,0	10,50	0125	●	●	●						
M14x1	1,00	100	20	10	-	11,0	9,0	13,00	0143	●	●	●						
M14x1,25	1,25	100	20	15	-	11,0	9,0	12,80	0144	●	●	●						
M14x1,5	1,50	100	20	15	-	11,0	9,0	12,50	0145	●	●	●						
M15x1	1,00	100	20	10	-	12,0	9,0	14,00	0153	○	○	○						
M16x1	1,00	100	20	10	-	12,0	9,0	15,00	0163	●	●	●						
M16x1,5	1,50	100	20	15	-	12,0	9,0	14,50	0165	●	●	●						
M18x1	1,00	110	24	13	-	14,0	11,0	17,00	0183	○	○	○						
M18x1,5	1,50	110	24	17	-	14,0	11,0	16,50	0185	●	●	●						
M18x2	2,00	125	27	20	-	14,0	11,0	16,00	0186	●	●	●						
M20x1	1,00	125	24	13	-	16,0	12,0	19,00	0203	○	○	○						
M20x1,5	1,50	125	24	17	-	16,0	12,0	18,50	0205	●	●	●						
M20x2	2,00	140	27	20	-	16,0	12,0	18,00	0206	●	●	●						
M22x1	1,00	125	24	13	-	18,0	14,5	21,00	0223	○	○	○						
M22x1,5	1,50	125	24	17	-	18,0	14,5	20,50	0225	●	●	●						
M22x2	2,00	140	27	20	-	18,0	14,5	20,00	0226	●	●	●						
M24x1	1,00	140	27	13	-	18,0	14,5	23,00	0243	○	○	○						
M24x1,5	1,50	140	27	20	-	18,0	14,5	22,50	0245	●	●	●						
M24x2	2,00	140	27	20	-	18,0	14,5	22,00	0246	●	●	●						
M25x1,5	1,50	140	27	20	-	18,0	14,5	23,50	0255	○	○	○						
M26x1,5	1,50	140	27	20	-	18,0	14,5	24,50	0265	○	○	○						
M27x1,5	1,50	140	27	20	-	20,0	16,0	25,50	0275	●	●	●						
M27x2	2,00	140	27	20	-	20,0	16,0	25,00	0276	●	●	●						
M28x1,5	1,50	140	27	20	-	20,0	16,0	26,50	0285	○	○	○						
● Dostępne z magazynu ○ Na zapytanie										ISO	Vc (m/min)							
										P	5-35	5-35	5-35					
										M	5-15	5-15	5-15					
										K	5-25	5-25	5-25					
										N	10-30	10-30	10-30					
										S	-	-	-					

800X

1

**Gwint metryczny drobnozwojny
ISO DIN-13**

HSSE

TN2

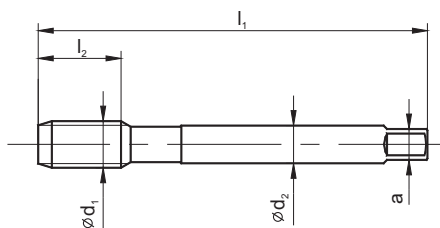
DIN
374

800X

C-TN2

B-TN2

C-R40-TN2



Rodzaj materiału obrabianego

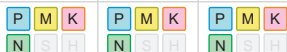

Typ otworu

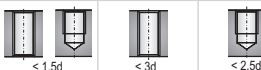

Rodzaj materiału

HSSE HSSE HSSE

Rodzaj powłoki

TN2 TN2 TN2

Nakrój

C / 2-3P B / 4-5P C / 2-3P

MF Ød ₁	P	l ₁	l ₂	l ₂ R40	l ₃	Ød ₂	a		Norma			DIN-374			
									Toł.	ISO2 (6H)		Toł.	ISO2 (6H)		
										INDEX	D2-123X01		D2-113X01	D2-513X01	D2-123X01
M28x2	2,0	140	27	20	-	20,0	16,0	26,00	0286	○	○	○			
M30x1,5	1,5	150	27	22	-	22,0	18,0	28,50	0305	●	●	●			
M30x2	2,0	150	27	22	-	22,0	18,0	28,00	0306	●	●	●			
M32x1,5	1,5	150	27	22	-	22,0	18,0	30,50	0325	○	○	○			
M32x2	2,0	150	27	22	-	22,0	18,0	30,00	0326	○	○	○			
M33x1,5	1,5	160	30	22	-	25,0	20,0	31,50	0335	○	○	○			
M33x2	2,0	160	30	24	-	25,0	20,0	31,00	0336	○	○	○			
M34x1,5	1,5	170	30	22	-	28,0	22,0	32,50	0345	○	○	○			
M35x1,5	1,5	170	30	22	-	28,0	22,0	33,50	0355	○	○	○			
M36x1,5	1,5	170	30	22	-	28,0	22,0	34,50	0365	○	○	○			
M36x2	2,0	170	30	24	-	28,0	22,0	34,00	0366	○	○	○			
M36x3	3,0	200	50	30	-	28,0	22,0	33,00	0367	○	○	○			
M38x1,5	1,5	170	30	24	-	28,0	22,0	36,50	0385	○	○	○			
M39x1,5	1,5	170	30	25	-	32,0	24,0	37,50	0395	○	○	○			
M39x2	2,0	170	30	25	-	32,0	24,0	37,00	0396	○	○	○			
M39x3	3,0	200	50	30	-	32,0	24,0	36,00	0397	○	○	○			
M40x1,5	1,5	170	30	25	-	32,0	24,0	38,50	0405	○	○	○			
M40x2	2,0	170	30	25	-	32,0	24,0	38,00	0406	○	○	○			
M42x1,5	1,5	170	30	25	-	32,0	24,0	40,50	0425	○	○	○			
M42x2	2,0	170	30	25	-	32,0	24,0	40,00	0426	○	○	○			
M42x3	3,0	200	50	30	-	32,0	24,0	39,00	0427	○	○	○			
M45x1,5	1,5	180	32	27	-	36,0	29,0	43,50	0455	○	○	○			
M45x2	2,0	180	32	27	-	36,0	29,0	43,00	0456	○	○	○			
M45x3	3,0	200	50	30	-	36,0	29,0	42,00	0457	○	○	○			
M48x1,5	1,5	190	32	27	-	36,0	29,0	46,50	0485	○	○	○			
M48x2	2,0	190	32	27	-	36,0	29,0	46,00	0486	○	○	○			
M48x3	3,0	225	50	33	-	36,0	29,0	45,00	0487	○	○	○			
M50x1,5	1,5	190	32	27	-	36,0	29,0	48,50	0505	○	○	○			
M50x2	2,0	190	32	27	-	36,0	29,0	48,00	0506	○	○	○			
M52x1,5	1,5	190	32	27	-	40,0	32,0	50,50	0525	○	○	○			
M52x2	2,0	190	32	27	-	40,0	32,0	50,00	0526	○	○	○			
M52x3	3,0	225	50	33	-	40,0	32,0	49,00	0527	○	○	○			

● Dostępne z magazynu

○ Na zapytanie

ISO	Vc (m/min)		
P	5-35	5-35	5-35
M	5-15	5-15	5-15
K	5-25	5-25	5-25
N	10-30	10-30	10-30
S	-	-	-

Przykład zamówienia

D2-123X01-0305

Gwintownik 800X M30x1,5-6H DIN-374 C HSSE TN2



Gwint metryczny drobnozwojny ISO DIN-13										800						
										C	B	C-R40				
Rodzaj materiału obrabianego																
Typ otworu																
Rodzaj materiału										HSSE	HSSE	HSSE				
Rodzaj powłoki																
Nakrój										C / 2-3P	B / 4-5P	C / 2-3P				
MF Ød ₁	P	l ₁	l ₂	l ₂ R40	l ₃	Ød ₂	a		Norma							
									DIN-371							
									Tol.	ISO2 (6H)	ISO2 (6H)	ISO2 (6H)				
										INDEX	C2-121101	C2-111101	C2-511101			
M3x0,35	0,35	56	10	5	18	3,5	2,7	2,65	0031	●	●	●				
M3,5x0,35	0,35	56	10	5	20	4,0	3,0	3,15	0036	●	●	●				
M4x0,5	0,50	63	12	7	21	4,5	3,4	3,50	0041	●	●	●				
M5x0,5	0,50	70	14	8	25	6,0	4,9	4,50	0051	●	●	●				
M6x0,75	0,75	80	14	10	30	6,0	4,9	5,20	0062	●	●	●				
M8x0,75	0,75	80	18	10	30	8,0	6,2	7,20	0082	●	●	●				
M8x1	1,00	90	20	13	35	8,0	6,2	7,00	0083	●	●	●				
M10x0,75	0,75	90	20	13	35	10,0	8,0	9,20	0102	●	●	●				
M10x1	1,00	90	20	13	35	10,0	8,0	9,00	0103	●	●	●				
M10x1,25	1,25	100	20	15	39	10,0	8,0	8,80	0104	●	●	●				
										ISO			Vc (m/min)			
										P	5-20	5-20	5-20			
										M	5-10	5-10	5-10			
										K	5-15	5-15	5-15			
										N	5-25	5-25	5-25			
										S	-	-	-			

1

**Gwint metryczny drobnozwojny
ISO DIN-13**

HSSE

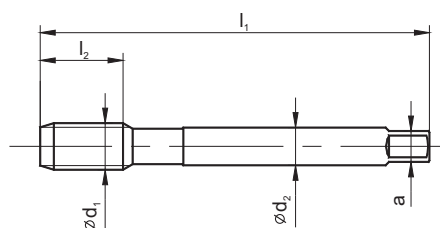
DIN
374

800

C

B

C-R40



Rodzaj materiału obrabianego



Typ otworu



Rodzaj materiału

HSSE HSSE HSSE

Rodzaj powłoki

Nakrój

C / 2-3P B / 4-5P C / 2-3P

MF ød ₁	P	l ₁	l ₂	R ₄₀ R ₄₅	l ₃	ød ₂	a		Norma			DIN-374			
									Tol.			ISO2 (6H)			
									INDEX			D2-121101	D2-111101	D2-511101	
M8x1	1,00	90	20	10	-	6,0	4,9	7,00	0083	●	●	●			
M9x1	1,00	90	20	10	-	7,0	5,5	8,00	0093	○	○	○			
M10x0,75	0,75	90	18	10	-	7,0	5,5	9,20	0102	●	●	●			
M10x1	1,00	90	20	10	-	7,0	5,5	9,00	0103	●	●	●			
M10x1,25	1,25	100	20	15	-	7,0	5,5	8,80	0104	●	●	●			
M11x1	1,00	90	20	10	-	8,0	6,2	10,00	0113	○	○	○			
M12x1	1,00	100	20	10	-	9,0	7,0	11,00	0123	●	●	●			
M12x1,25	1,25	100	20	15	-	9,0	7,0	10,80	0124	●	●	●			
M12x1,5	1,50	100	20	15	-	9,0	7,0	10,50	0125	●	●	●			
M14x1	1,00	100	20	10	-	11,0	9,0	13,00	0143	●	●	●			
M14x1,25	1,25	100	20	15	-	11,0	9,0	12,80	0144	●	●	●			
M14x1,5	1,50	100	20	15	-	11,0	9,0	12,50	0145	●	●	●			
M15x1	1,00	100	20	10	-	12,0	9,0	14,00	0153	○	○	○			
M16x1	1,00	100	20	10	-	12,0	9,0	15,00	0163	●	●	●			
M16x1,5	1,50	100	20	15	-	12,0	9,0	14,50	0165	●	●	●			
M18x1	1,00	110	24	13	-	14,0	11,0	17,00	0183	○	○	○			
M18x1,5	1,50	110	24	17	-	14,0	11,0	16,50	0185	●	●	●			
M18x2	2,00	125	27	20	-	14,0	11,0	16,00	0186	●	●	●			
M20x1	1,00	125	24	13	-	16,0	12,0	19,00	0203	○	○	○			
M20x1,5	1,50	125	24	17	-	16,0	12,0	18,50	0205	●	●	●			
M20x2	2,00	140	27	20	-	16,0	12,0	18,00	0206	●	●	●			
M22x1	1,00	125	24	13	-	18,0	14,5	21,00	0223	○	○	○			
M22x1,5	1,50	125	24	17	-	18,0	14,5	20,50	0225	●	●	●			
M22x2	2,00	140	27	20	-	18,0	14,5	20,00	0226	●	●	●			
M24x1	1,00	140	27	13	-	18,0	14,5	23,00	0243	○	○	○			
M24x1,5	1,50	140	27	20	-	18,0	14,5	22,50	0245	●	●	●			
M24x2	2,00	140	27	20	-	18,0	14,5	22,00	0246	●	●	●			
M25x1,5	1,50	140	27	20	-	18,0	14,5	23,50	0255	○	○	○			
M26x1,5	1,50	140	27	20	-	18,0	14,5	24,50	0265	○	○	○			
M27x1,5	1,50	140	27	20	-	20,0	16,0	25,50	0275	●	●	●			
M27x2	2,00	140	27	20	-	20,0	16,0	25,00	0276	●	●	●			
M28x1,5	1,50	140	27	20	-	20,0	16,0	26,50	0285	○	○	○			

● Dostępne z magazynu

○ Na zapytanie

ISO	Vc (m/min)		
P	5-20	5-20	5-20
M	5-10	5-10	5-10
K	5-15	5-15	5-15
N	5-25	5-25	5-25
S	-	-	-

Przykład zamówienia

D2-121101-0083

Gwintownik 800 M8x1-6H DIN-374 C HSSE



Gwint metryczny drobnoszwyjny ISO DIN-13										800							
										C	B	C-R40					
Rodzaj materiału obrabianego																	
Typ otworu																	
Rodzaj materiału										HSSE	HSSE	HSSE					
Rodzaj powłoki																	
Nakrój										C / 2-3P	B / 4-5P	C / 2-3P					
MF Ød ₁	P	l ₁	l ₂	l ₂ R40	l ₃	Ød ₂	a		Norma	DIN-374							
									Tol.	ISO2 (6H)	ISO2 (6H)	ISO2 (6H)					
										INDEX	D2-121101	D2-111101	D2-511101				
M28x2	2,0	140	27	20	-	20,0	16,0	26,00	0286	○	○	○					
M30x1,5	1,5	150	27	22	-	22,0	18,0	28,50	0305	●	●	●					
M30x2	2,0	150	27	22	-	22,0	18,0	28,00	0306	●	●	●					
M32x1,5	1,5	150	27	22	-	22,0	18,0	30,50	0325	○	○	○					
M32x2	2,0	150	27	22	-	22,0	18,0	30,00	0326	○	○	○					
M33x1,5	1,5	160	30	22	-	25,0	20,0	31,50	0335	●	●	●					
M33x2	2,0	160	30	24	-	25,0	20,0	31,00	0336	●	●	●					
M34x1,5	1,5	170	30	22	-	28,0	22,0	32,50	0345	○	○	○					
M35x1,5	1,5	170	30	22	-	28,0	22,0	33,50	0355	○	○	○					
M36x1,5	1,5	170	30	22	-	28,0	22,0	34,50	0365	●	●	●					
M36x2	2,0	170	30	24	-	28,0	22,0	34,00	0366	●	●	●					
M36x3	3,0	200	50	30	-	28,0	22,0	33,00	0367	○	○	○					
M38x1,5	1,5	170	30	24	-	28,0	22,0	36,50	0385	○	○	○					
M39x1,5	1,5	170	30	25	-	32,0	24,0	37,50	0395	○	○	○					
M39x2	2,0	170	30	25	-	32,0	24,0	37,00	0396	○	○	○					
M39x3	3,0	200	50	30	-	32,0	24,0	36,00	0397	○	○	○					
M40x1,5	1,5	170	30	25	-	32,0	24,0	38,50	0405	○	○	○					
M40x2	2,0	170	30	25	-	32,0	24,0	38,00	0406	○	○	○					
M42x1,5	1,5	170	30	25	-	32,0	24,0	40,50	0425	○	○	○					
M42x2	2,0	170	30	25	-	32,0	24,0	40,00	0426	○	○	○					
M42x3	3,0	200	50	30	-	32,0	24,0	39,00	0427	○	○	○					
M45x1,5	1,5	180	32	27	-	36,0	29,0	43,50	0455	○	○	○					
M45x2	2,0	180	32	27	-	36,0	29,0	43,00	0456	○	○	○					
M45x3	3,0	200	50	30	-	36,0	29,0	42,00	0457	○	○	○					
M48x1,5	1,5	190	32	27	-	36,0	29,0	46,50	0485	○	○	○					
M48x2	2,0	190	32	27	-	36,0	29,0	46,00	0486	○	○	○					
M48x3	3,0	225	50	33	-	36,0	29,0	45,00	0487	○	○	○					
M50x1,5	1,5	190	32	27	-	36,0	29,0	48,50	0505	○	○	○					
M50x2	2,0	190	32	27	-	36,0	29,0	48,00	0506	○	○	○					
M52x1,5	1,5	190	32	27	-	40,0	32,0	50,50	0525	○	○	○					
M52x2	2,0	190	32	27	-	40,0	32,0	50,00	0526	○	○	○					
M52x3	3,0	225	50	33	-	40,0	32,0	49,00	0527	○	○	○					

- Dostępne z magazynu
- Na zapytanie

ISO	Vc (m/min)					
P	5-20	5-20	5-20			
M	5-10	5-10	5-10			
K	5-15	5-15	5-15			
N	5-25	5-25	5-25			
S	-	-	-			

Przykład zamówienia

 D2-121101-0286
 Gwintownik 800 M28x2-6H DIN-374 C HSSE

1

Gwint metryczny drobnozwojny ISO DIN-13										<i>FAN-1200</i>		<i>1400-HT</i>		
										B-TS	C-R40-TS	C-TS	B-TS	C-R15-TS
Rodzaj materiału obrabianego														
Typ otworu														
Rodzaj materiału										HSSE-PM		HSSE-PM		
Rodzaj powłoki										TS		TS		
Nakrój										B / 4-5P		C / 2-3P		
MF $\varnothing d_1$	P	l_1	l_2	l_2 R40	l_3	$\varnothing d_2$	a		Norma					
									DIN-371					
									Tol.	ISO2 (6H)	ISO2 (6H)	6HX	6HX	6HX
									INDEX	C4-115001	C4-565001	C4-12G901	C4-11G901	C4-50G901
M4x0,5	0,50	63	12	7	21	4,5	3,4	3,50	0041	○	○	○	○	○
M5x0,5	0,50	70	14	8	25	6,0	4,9	4,50	0051	○	○	○	○	○
M6x0,75	0,75	80	14	10	30	6,0	4,9	5,20	0062	○	○	○	○	○
M8x0,75	0,75	80	18	10	30	8,0	6,2	7,20	0082	○	○	○	○	○
M8x1	1,00	90	20	13	35	8,0	6,2	7,00	0083	●	●	●	●	●
M10x0,75	0,75	90	20	13	35	10,0	8,0	9,20	0102	○	○	○	○	○
M10x1	1,00	90	20	13	35	10,0	8,0	9,00	0103	●	●	●	●	●
M10x1,25	1,25	100	20	15	39	10,0	8,0	8,80	0104	○	○	○	○	○

ISO	Vc (m/min)				
P	5-35	5-35	1-20	1-20	1-20
M	5-15	5-15	1-10	1-10	1-10
K	5-25	5-25	1-20	1-20	1-20
N	10-30	10-30	10-20	10-20	10-20
S	-	-	-	-	-



Gwint metryczny drobnozwojny ISO DIN-13										<i>FAN-1200</i>		<i>1400-HT</i>							
										B-TS	C-R40-TS	C-TS	B-TS	C-R15-TS					
Rodzaj materiału obrabianego																			
Typ otworu																			
Rodzaj materiału										PM/HSSE		PM/HSSE		PM/HSSE		PM/HSSE			
Rodzaj powłoki										TS		TS		TS		TS			
Nakrój										B / 4-5P		C / 2-3P		C / 2-3P		B / 4-5P		C / 2-3P	
MF Ød ₁	P	l ₁	l ₂	l ₂ R40	l ₃	Ød ₂	a		Norma										
									DIN-374										
									ISO2 (6H)	ISO2 (6H)	6HX	6HX	6HX	ISO2 (6H)	ISO2 (6H)	6HX	6HX	6HX	
INDEX	D4-115001	D4-565001	D4-12G901	D4-11G901	D4-50G901														
M8x1	1,00	90	20	10	-	6,0	4,9	7,00	0083	●	●	●	●	●					
M10x0,75	0,75	90	18	10	-	7,0	5,5	9,20	0102	○	○	○	○	○					
M10x1	1,00	90	20	10	-	7,0	5,5	9,00	0103	●	●	●	●	●					
M10x1,25	1,25	100	20	15	-	7,0	5,5	8,80	0104	○	○	○	○	○					
M12x1	1,00	100	20	10	-	9,0	7,0	11,00	0123	●	●	●	●	●					
M12x1,25	1,25	100	20	15	-	9,0	7,0	10,80	0124	●	●	●	●	●					
M12x1,5	1,50	100	20	15	-	9,0	7,0	10,50	0125	●	●	●	●	●					
M14x1	1,00	100	20	10	-	11,0	9,0	13,00	0143	○	○	○	○	●					
M14x1,25	1,25	100	20	15	-	11,0	9,0	12,80	0144	○	○	○	○	○					
M14x1,5	1,50	100	20	15	-	11,0	9,0	12,50	0145	●	●	●	●	●					
M16x1	1,00	100	20	10	-	12,0	9,0	15,00	0163	●	●	●	●	●					
M16x1,5	1,50	100	20	15	-	12,0	9,0	14,50	0165	●	●	●	●	●					
M18x1	1,00	110	24	13	-	14,0	11,0	17,00	0183	○	○	○	○	○					
M18x1,5	1,50	110	24	17	-	14,0	11,0	16,50	0185	●	●	●	●	●					
M18x2	2,00	125	32	27	-	14,0	11,0	16,00	0186	●	○	○	○	○					
M20x1	1,00	125	24	13	-	16,0	12,0	19,00	0203	○	○	○	○	○					
M20x1,5	1,50	125	24	17	-	16,0	12,0	18,50	0205	●	●	●	●	●					
M20x2	2,00	140	32	27	-	16,0	12,0	18,00	0206	○	○	○	○	○					
M22x1	1,00	125	24	13	-	18,0	14,5	21,00	0223	○	○	○	○	○					
M22x1,5	1,50	125	24	17	-	18,0	14,5	20,50	0225	○	○	○	○	○					
M22x2	2,00	140	32	27	-	18,0	14,5	20,00	0226	○	○	○	○	○					
M24x1	1,00	140	27	13	-	18,0	14,5	23,00	0243	○	○	○	○	○					
M24x1,5	1,50	140	27	20	-	18,0	14,5	22,50	0245	○	○	○	○	○					
M24x2	2,00	140	27	20	-	18,0	14,5	22,00	0246	○	○	○	○	○					
										Vc (m/min)									
ISO										P		M		K		N		S	
										5-35		5-35		1-20		1-20		1-20	
										5-15		5-15		1-10		1-10		1-10	
										5-25		5-25		1-20		1-20		1-20	
										10-30		10-30		10-20		10-20		10-20	
										-		-		-		-		-	

1

Gwint metryczny drobnozwojny ISO DIN-13										INOX														
										B	B-HL	C-R40	C-R40-HL											
<div style="display: flex; flex-direction: column; align-items: center;"> <div style="border: 1px solid black; padding: 2px; margin-bottom: 5px;">HSSE</div> <div style="border: 1px solid black; padding: 2px; margin-bottom: 5px;">HL</div> <div style="border: 1px solid black; padding: 2px;">DIN 371</div> </div>																								
Rodzaj materiału obrabianego										<table border="1"> <tr><td>P</td><td>M</td><td>K</td><td></td></tr> <tr><td>N</td><td>S</td><td>H</td><td></td></tr> </table>				P	M	K		N	S	H				
P	M	K																						
N	S	H																						
Typ otworu										<table border="1"> <tr><td></td><td></td><td></td><td></td></tr> <tr><td><3d</td><td><3d</td><td><2.5d</td><td><2.5d</td></tr> </table>								<3d	<3d	<2.5d	<2.5d			
<3d	<3d	<2.5d	<2.5d																					
Rodzaj materiału										HSSE														
Rodzaj powłoki														HL										
Nakrój										B / 4-5P				B / 4-5P										
										C / 2-3P				C / 2-3P										
MF $\varnothing d_1$	P	l_1	l_2	l_2 R40	l_3	$\varnothing d_2$	a		Norma															
									DIN-371															
									Tol.	ISO2 (6H)	ISO2 (6H)	ISO2 (6H)	ISO2 (6H)											
									INDEX	C2-111801	C2-118801	C2-511801	C2-518801											
M4x0,5	0,50	63	12	7	21	4,5	3,4	3,50	0041	●	●	●	●											
M5x0,5	0,50	70	14	8	25	6,0	4,9	4,50	0051	●	●	●	●											
M6x0,75	0,75	80	14	10	30	6,0	4,9	5,20	0062	●	●	●	●											
M8x0,75	0,75	80	18	10	30	8,0	6,2	7,20	0082	●	●	●	●											
M8x1	1,00	90	20	13	35	8,0	6,2	7,00	0083	●	●	●	●											
M10x0,75	0,75	90	20	13	35	10,0	8,0	9,20	0102	●	●	●	●											
M10x1	1,00	90	20	13	35	10,0	8,0	9,00	0103	●	●	●	●											
M10x1,25	1,25	100	20	15	39	10,0	8,0	8,80	0104	●	●	●	●											
										ISO					Vc (m/min)									
										P					-									
										M					5-15									
										K					-									
										N					-									
										S					-									



Gwint metryczny drobnozwojny ISO DIN-13										INOX							
										B	B-HL	C-R40	C-R40-HL				
Rodzaj materiału obrabianego										P M K P M K P M K P M K N S H N S H N S H N S H							
Typ otworu																	
Rodzaj materiału										HSSE HSSE HSSE HSSE							
Rodzaj powłoki										HL HL							
Nakrój										B / 4-5P B / 4-5P C / 2-3P C / 2-3P							
MF	Ød ₁	P	l ₁	l ₂	l ₂ R40	l ₃	Ød ₂	a		Norma							
										DIN-374							
										Tol.	ISO2 (6H)	ISO2 (6H)	ISO2 (6H)	ISO2 (6H)			
										INDEX	D2-111801	D2-118801	D2-511801	D2-518801			
M8x1	1,00	90	20	10	-	6,0	4,9	7,00	0083	●	○	●	○				
M10x0,75	0,75	90	18	10	-	7,0	5,5	9,20	0102	●	○	●	○				
M10x1	1,00	90	20	10	-	7,0	5,5	9,00	0103	●	●	●	●				
M10x1,25	1,25	100	20	15	-	7,0	5,5	8,80	0104	●	○	●	○				
M12x1	1,00	100	20	10	-	9,0	7,0	11,00	0123	●	○	●	○				
M12x1,25	1,25	100	20	15	-	9,0	7,0	10,80	0124	●	○	●	○				
M12x1,5	1,50	100	20	15	-	9,0	7,0	10,50	0125	●	●	●	●				
M14x1	1,00	100	20	10	-	11,0	9,0	13,00	0143	○	○	○	○				
M14x1,25	1,25	100	20	15	-	11,0	9,0	12,80	0144	○	○	○	○				
M14x1,5	1,50	100	20	15	-	11,0	9,0	12,50	0145	●	○	●	○				
M15x1	1,00	100	20	10	-	12,0	9,0	14,00	0153	○	○	○	○				
M16x1	1,00	100	20	10	-	12,0	9,0	15,00	0163	●	○	●	○				
M16x1,5	1,50	100	20	15	-	12,0	9,0	14,50	0165	●	●	●	●				
M18x1	1,00	110	24	13	-	14,0	11,0	17,00	0183	○	○	○	○				
M18x1,5	1,50	110	24	17	-	14,0	11,0	16,50	0185	●	○	●	○				
M18x2	2,00	125	27	20	-	14,0	11,0	16,00	0186	○	○	○	○				
M20x1	1,00	125	24	13	-	16,0	12,0	19,00	0203	○	○	○	○				
M20x1,5	1,50	125	24	17	-	16,0	12,0	18,50	0205	●	●	●	●				
M20x2	2,00	140	27	20	-	16,0	12,0	18,00	0206	○	○	○	○				
M22x1	1,00	125	24	13	-	18,0	14,5	21,00	0223	○	○	○	○				
M22x1,5	1,50	125	24	17	-	18,0	14,5	20,50	0225	●	○	●	○				
M22x2	2,00	140	27	20	-	18,0	14,5	20,00	0226	○	○	○	○				
M24x1	1,00	140	27	13	-	18,0	14,5	23,00	0243	○	○	○	○				
M24x1,5	1,50	140	27	20	-	18,0	14,5	22,50	0245	○	○	○	○				
M24x2	2,00	140	27	20	-	18,0	14,5	22,00	0246	○	○	○	○				
M26x1,5	1,50	140	27	20	-	18,0	14,5	24,50	0265	○	○	○	○				
M27x1,5	1,50	140	27	20	-	20,0	16,0	25,50	0275	○	○	○	○				
M27x2	2,00	140	27	20	-	20,0	16,0	25,00	0276	○	○	○	○				
M28x1,5	1,50	140	27	20	-	20,0	16,0	26,50	0285	○	○	○	○				
										ISO				Vc (m/min)			
										P				-			
										M				5-15			
										K				-			
										N				-			
										S				-			

- Dostępne z magazynu
- Na zapytanie

Przykład zamówienia

 D2-118801-0083
 Gwintownik INOX M8x1-6H DIN-374 B HSSE HL

1

Gwint metryczny drobnozwojny ISO DIN-13										INOX																																																																																																																																																																																																																																																												
										B	B-HL	C-R40	C-R40-HL																																																																																																																																																																																																																																																									
<div style="display: flex; flex-direction: column; align-items: flex-start;"> <div style="border: 1px solid black; padding: 2px; margin-bottom: 5px;">HSSE</div> <div style="border: 1px solid black; padding: 2px; margin-bottom: 5px;">HL</div> <div style="border: 1px solid black; padding: 2px;">DIN 374</div> </div>																																																																																																																																																																																																																																																																						
Rodzaj materiału obrabianego										<table border="1" style="font-size: 8px;"> <tr><td>P</td><td>M</td><td>K</td></tr> <tr><td>N</td><td>S</td><td>H</td></tr> </table>	P	M	K	N	S	H	<table border="1" style="font-size: 8px;"> <tr><td>P</td><td>M</td><td>K</td></tr> <tr><td>N</td><td>S</td><td>H</td></tr> </table>	P	M	K	N	S	H	<table border="1" style="font-size: 8px;"> <tr><td>P</td><td>M</td><td>K</td></tr> <tr><td>N</td><td>S</td><td>H</td></tr> </table>	P	M	K	N	S	H	<table border="1" style="font-size: 8px;"> <tr><td>P</td><td>M</td><td>K</td></tr> <tr><td>N</td><td>S</td><td>H</td></tr> </table>	P	M	K	N	S	H																																																																																																																																																																																																																																	
P	M	K																																																																																																																																																																																																																																																																				
N	S	H																																																																																																																																																																																																																																																																				
P	M	K																																																																																																																																																																																																																																																																				
N	S	H																																																																																																																																																																																																																																																																				
P	M	K																																																																																																																																																																																																																																																																				
N	S	H																																																																																																																																																																																																																																																																				
P	M	K																																																																																																																																																																																																																																																																				
N	S	H																																																																																																																																																																																																																																																																				
Typ otworu										 <math>< 3d</math>	 <math>< 3d</math>	 <math>< 2.5d</math>	 <math>< 2.5d</math>																																																																																																																																																																																																																																																									
Rodzaj materiału										HSSE	HSSE	HSSE	HSSE																																																																																																																																																																																																																																																									
Rodzaj powłoki											HL		HL																																																																																																																																																																																																																																																									
Nakrój										B / 4-5P	B / 4-5P	C / 2-3P	C / 2-3P																																																																																																																																																																																																																																																									
<table border="1" style="font-size: 8px;"> <thead> <tr> <th rowspan="2">MF $\varnothing d_1$</th> <th rowspan="2">P</th> <th rowspan="2">l_1</th> <th rowspan="2">l_2</th> <th rowspan="2">l_2 R40</th> <th rowspan="2">l_3</th> <th rowspan="2">$\varnothing d_2$</th> <th rowspan="2">a</th> <th rowspan="2"> </th> <th colspan="2">Norma</th> <th colspan="4">DIN-374</th> <th colspan="2"></th> <th colspan="2"></th> </tr> <tr> <th>Tol.</th> <th>INDEX</th> <th>ISO2 (6H)</th> <th>ISO2 (6H)</th> <th>ISO2 (6H)</th> <th>ISO2 (6H)</th> <th></th> <th></th> <th></th> <th></th> </tr> </thead> <tbody> <tr><td>M28x2</td><td>2,0</td><td>140</td><td>27</td><td>20</td><td>-</td><td>20,0</td><td>16,0</td><td>26,00</td><td>0286</td><td>o</td><td>o</td><td>o</td><td>o</td><td></td><td></td><td></td><td></td></tr> <tr><td>M30x1,5</td><td>1,5</td><td>150</td><td>27</td><td>22</td><td>-</td><td>22,0</td><td>18,0</td><td>28,50</td><td>0305</td><td>o</td><td>o</td><td>o</td><td>o</td><td></td><td></td><td></td><td></td></tr> <tr><td>M30x2</td><td>2,0</td><td>150</td><td>27</td><td>22</td><td>-</td><td>22,0</td><td>18,0</td><td>28,00</td><td>0306</td><td>o</td><td>o</td><td>o</td><td>o</td><td></td><td></td><td></td><td></td></tr> <tr><td>M32x1,5</td><td>1,5</td><td>150</td><td>27</td><td>22</td><td>-</td><td>22,0</td><td>18,0</td><td>30,50</td><td>0325</td><td>o</td><td>o</td><td>o</td><td>o</td><td></td><td></td><td></td><td></td></tr> <tr><td>M32x2</td><td>2,0</td><td>150</td><td>27</td><td>22</td><td>-</td><td>22,0</td><td>18,0</td><td>30,00</td><td>0326</td><td>o</td><td>o</td><td>o</td><td>o</td><td></td><td></td><td></td><td></td></tr> <tr><td>M33x1,5</td><td>1,5</td><td>160</td><td>30</td><td>22</td><td>-</td><td>25,0</td><td>20,0</td><td>31,50</td><td>0335</td><td>o</td><td>o</td><td>o</td><td>o</td><td></td><td></td><td></td><td></td></tr> <tr><td>M33x2</td><td>2,0</td><td>160</td><td>30</td><td>24</td><td>-</td><td>25,0</td><td>20,0</td><td>31,00</td><td>0336</td><td>o</td><td>o</td><td>o</td><td>o</td><td></td><td></td><td></td><td></td></tr> <tr><td>M34x1,5</td><td>1,5</td><td>170</td><td>30</td><td>22</td><td>-</td><td>28,0</td><td>22,0</td><td>32,50</td><td>0345</td><td>o</td><td>o</td><td>o</td><td>o</td><td></td><td></td><td></td><td></td></tr> <tr><td>M35x1,5</td><td>1,5</td><td>170</td><td>30</td><td>22</td><td>-</td><td>28,0</td><td>22,0</td><td>33,50</td><td>0355</td><td>o</td><td>o</td><td>o</td><td>o</td><td></td><td></td><td></td><td></td></tr> <tr><td>M36x1,5</td><td>1,5</td><td>170</td><td>30</td><td>22</td><td>-</td><td>28,0</td><td>22,0</td><td>34,50</td><td>0365</td><td>o</td><td>o</td><td>o</td><td>o</td><td></td><td></td><td></td><td></td></tr> <tr><td>M36x2</td><td>2,0</td><td>170</td><td>30</td><td>24</td><td>-</td><td>28,0</td><td>22,0</td><td>34,00</td><td>0366</td><td>o</td><td>o</td><td>o</td><td>o</td><td></td><td></td><td></td><td></td></tr> <tr><td>M36x3</td><td>3,0</td><td>200</td><td>50</td><td>30</td><td>-</td><td>28,0</td><td>22,0</td><td>33,00</td><td>0367</td><td>o</td><td>o</td><td>o</td><td>o</td><td></td><td></td><td></td><td></td></tr> </tbody> </table>										MF $\varnothing d_1$	P	l_1	l_2	l_2 R40	l_3	$\varnothing d_2$	a		Norma		DIN-374								Tol.	INDEX	ISO2 (6H)	ISO2 (6H)	ISO2 (6H)	ISO2 (6H)					M28x2	2,0	140	27	20	-	20,0	16,0	26,00	0286	o	o	o	o					M30x1,5	1,5	150	27	22	-	22,0	18,0	28,50	0305	o	o	o	o					M30x2	2,0	150	27	22	-	22,0	18,0	28,00	0306	o	o	o	o					M32x1,5	1,5	150	27	22	-	22,0	18,0	30,50	0325	o	o	o	o					M32x2	2,0	150	27	22	-	22,0	18,0	30,00	0326	o	o	o	o					M33x1,5	1,5	160	30	22	-	25,0	20,0	31,50	0335	o	o	o	o					M33x2	2,0	160	30	24	-	25,0	20,0	31,00	0336	o	o	o	o					M34x1,5	1,5	170	30	22	-	28,0	22,0	32,50	0345	o	o	o	o					M35x1,5	1,5	170	30	22	-	28,0	22,0	33,50	0355	o	o	o	o					M36x1,5	1,5	170	30	22	-	28,0	22,0	34,50	0365	o	o	o	o					M36x2	2,0	170	30	24	-	28,0	22,0	34,00	0366	o	o	o	o					M36x3	3,0	200	50	30	-	28,0	22,0	33,00	0367	o	o	o	o												
																			MF $\varnothing d_1$	P	l_1	l_2	l_2 R40	l_3	$\varnothing d_2$	a		Norma		DIN-374																																																																																																																																																																																																																																								
Tol.	INDEX	ISO2 (6H)	ISO2 (6H)	ISO2 (6H)	ISO2 (6H)																																																																																																																																																																																																																																																																	
M28x2	2,0	140	27	20	-	20,0	16,0	26,00	0286	o	o	o	o																																																																																																																																																																																																																																																									
M30x1,5	1,5	150	27	22	-	22,0	18,0	28,50	0305	o	o	o	o																																																																																																																																																																																																																																																									
M30x2	2,0	150	27	22	-	22,0	18,0	28,00	0306	o	o	o	o																																																																																																																																																																																																																																																									
M32x1,5	1,5	150	27	22	-	22,0	18,0	30,50	0325	o	o	o	o																																																																																																																																																																																																																																																									
M32x2	2,0	150	27	22	-	22,0	18,0	30,00	0326	o	o	o	o																																																																																																																																																																																																																																																									
M33x1,5	1,5	160	30	22	-	25,0	20,0	31,50	0335	o	o	o	o																																																																																																																																																																																																																																																									
M33x2	2,0	160	30	24	-	25,0	20,0	31,00	0336	o	o	o	o																																																																																																																																																																																																																																																									
M34x1,5	1,5	170	30	22	-	28,0	22,0	32,50	0345	o	o	o	o																																																																																																																																																																																																																																																									
M35x1,5	1,5	170	30	22	-	28,0	22,0	33,50	0355	o	o	o	o																																																																																																																																																																																																																																																									
M36x1,5	1,5	170	30	22	-	28,0	22,0	34,50	0365	o	o	o	o																																																																																																																																																																																																																																																									
M36x2	2,0	170	30	24	-	28,0	22,0	34,00	0366	o	o	o	o																																																																																																																																																																																																																																																									
M36x3	3,0	200	50	30	-	28,0	22,0	33,00	0367	o	o	o	o																																																																																																																																																																																																																																																									
										ISO																																																																																																																																																																																																																																																												

ISO	Vc (m/min)					
P	-	-	-	-		
M	5-15	5-15	5-15	5-15		
K	-	-	-	-		
N	-	-	-	-		
S	-	-	-	-		



Gwint metryczny drobnozwojny ISO DIN-13									GG					GAL				
									C-TS	C-IK-TS	E-TS	E-IK-TS	E-IKR-TS	C-R15-TS	E-R15-IK-TS			
Rodzaj materiału obrabianego									P M K		P M K		P M K		P M K		P M K	
Typ otworu									N S H		N S H		N S H		N S H		N S H	
Rodzaj materiału									N S H		N S H		N S H		N S H		N S H	
Rodzaj powłoki									N		N		N		N		N	
Nakrój									< 2d		< 2,5d		< 2d		< 2,5d		< 2,5d	
Rodzaj materiału									HSSE-PM		HSSE-PM		HSSE-PM		HSSE-PM		HSSE-PM	
Rodzaj powłoki									TS		TS		TS		TS		TS	
Nakrój									C / 2-3P		C / 2-3P		E / 1,5-2P		E / 1,5-2P		C / 2-3P	
MF ød ₁	P	l ₁	l ₂	l ₃	ød ₂	a		Norma										
								DIN-371										
								Tol.	6HX	6HX	6HX	6HX	6HX	6HX	6HX			
								INDEX	C2-125501	C4-125551	C2-145501	C4-145551	C4-145561	C2-505601	C4-655601			
M8x1	1,00	90	20	35	8,0	6,2	7,00	0083	●	○	●	○	○	●	○			
M10x0,75	0,75	90	20	35	10,0	8,0	9,20	0102	○	○	○	○	○	○	○			
M10x1	1,00	90	20	35	10,0	8,0	9,00	0103	●	○	●	○	○	●	○			
M10x1,25	1,25	100	20	39	10,0	8,0	8,80	0104	○	○	●	○	○	●	○			
ISO									Vc (m/min)									
P									-	-	-	-	-	-	-			
M									-	-	-	-	-	-	-			
K									1-60	1-60	1-60	1-60	1-60	-	-			
N									-	-	-	-	-	10-30	10-30			
S									-	-	-	-	-	-	-			

1

Gwint metryczny drobnozwojny ISO DIN-13								GG					GAL		
								C-TS	C-IK-TS	E-TS	E-IK-TS	E-IKR-TS	C-R15-TS	E-R15-IK-TS	
Rodzaj materiału obrabianego															
Typ otworu															
Rodzaj materiału								HSSE-PM HSSE-PM HSSE-PM HSSE-PM HSSE-PM HSSE-PM HSSE-PM							
Rodzaj powłoki								TS TS TS TS TS TS TS							
Nakrój								C / 2-3P C / 2-3P E / 1,5-2P E / 1,5-2P E / 1,5-2P C / 2-3P E / 1,5-2P							
MF ød ₁	P	l ₁	l ₂	ød ₂	a		Norma	DIN-374							
								Tol.	6HX	6HX	6HX	6HX	6HX	6HX	6HX
								INDEX	D2-125501	D4-125551	D2-145501	D4-145551	D4-145561	D2-505601	D4-655651
M8x1	1,00	90	20	6,0	4,9	7,00	0083	●	○	●	○	○	●	○	
M10x0,75	0,75	90	18	7,0	5,5	9,2	0102	○	○	○	○	○	○	○	
M10x1	1,00	90	20	7,0	5,5	9,00	0103	●	●	●	○	○	●	●	
M10x1,25	1,25	100	20	7,0	5,5	8,80	0104	○	○	○	○	○	○	○	
M12x1	1,00	100	20	9,0	7,0	11,00	0123	○	○	○	○	○	○	○	
M12x1,25	1,25	100	20	9,0	7,0	10,80	0124	○	○	○	○	○	○	○	
M12x1,5	1,50	100	20	9,0	7,0	10,50	0125	●	●	●	○	○	●	●	
M14x1	1,00	100	20	11,0	9,0	13,00	0143	○	○	○	○	○	○	○	
M14x1,25	1,25	100	20	11,0	9,0	12,80	0144	○	○	○	○	○	○	○	
M14x1,5	1,50	100	20	11,0	9,0	12,50	0145	●	●	●	○	○	●	●	
M16x1	1,00	100	20	12,0	9,0	15,00	0163	○	○	○	○	○	○	○	
M16x1,5	1,50	100	20	12,0	9,0	14,50	0165	●	●	●	○	○	●	●	
M18x1	1,00	110	24	14,0	11,0	17,00	0183	○	○	○	○	○	○	○	
M18x1,5	1,50	110	24	14,0	11,0	16,50	0185	●	○	●	○	○	○	○	
M18x2	2,00	125	27	14,0	11,0	16,00	0186	○	○	○	○	○	○	○	
M20x1	1,00	125	24	16,0	12,0	19,00	0203	○	○	○	○	○	○	○	
M20x1,5	1,50	125	24	16,0	12,0	18,50	0205	●	○	○	○	○	○	○	
M20x2	2,00	140	27	16,0	12,0	18,00	0206	○	○	○	○	○	○	○	
								Vc (m/min)							
ISO															
P								-	-	-	-	-	-	-	
M								-	-	-	-	-	-	-	
K								1-60	1-60	1-60	1-60	1-60	-	-	
N								-	-	-	-	-	10-30	10-30	
S								-	-	-	-	-	-	-	



Gwint metryczny drobnozwojny ISO DIN-13									S-NC						
									B-TC	C-R45-TC	C-R45-IK-TC				
Rodzaj materiału obrabianego															
Typ otworu															
Rodzaj materiału									HSSE-PM HSSE-PM HSSE-PM						
Rodzaj powłoki									TC TC TC						
Nakrój									B / 4-5P C / 2-3P C / 2-3P						
MF Ød ₁	P	l ₁	l ₂	l ₃	Ød ₂	a		Norma							
								DIN-371							
								Tol.	6HX	6HX	6HX				
									INDEX	C4-115301	C4-525301	C4-525351			
M4x0,5	0,50	63	7	21	4,5	3,4	3,50	0041	○	○	○				
M5x0,5	0,50	70	8	25	6,0	4,9	4,50	0051	○	○	○				
M6x0,75	0,75	80	10	30	6,0	4,9	5,20	0062	○	○	○				
M8x0,75	0,75	80	10	30	8,0	6,2	7,20	0082	●	●	○				
M8x1	1,00	90	13	35	8,0	6,2	7,00	0083	○	○	○				
M10x0,75	0,75	90	13	35	10,0	8,0	9,20	0102	○	○	○				
M10x1	1,00	90	13	35	10,0	8,0	9,00	0103	●	●	○				
M10x1,25	1,25	100	15	39	10,0	8,0	8,80	0104	○	○	○				
									V _c (m/min)						
									P	5-50	5-50	5-60			
									M	5-20	5-20	5-30			
									K	5-40	5-40	5-60			
									N	5-40	5-40	5-60			
									S	1-8	1-8	1-8			

1

**Gwint metryczny drobnozwojny
ISO DIN-13**

S-NC

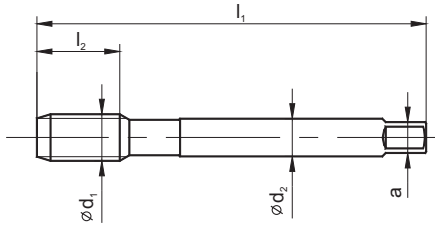
**HSSE
PM**
TC
**DIN
374**

B-TC **C-R45-TC** **C-R45-IK-TC**

Rodzaj materiału obrabianego

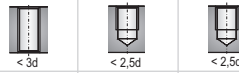

Typ otworu



Rodzaj materiału

PM/HSSE PM/HSSE PM/HSSE

Rodzaj powłoki

TC TC TC

Nakrój

B / 4-5P C / 2-3P C / 2-3P

MF ød ₁	P	l ₁	l ₂	l ₃	ød ₂	a		Norma							
								DIN-374							
								Tol.	6HX	6HX					6HX
INDEX	D4-115301	D4-525301	D4-525351												
M8x1	1,00	90	10	-	6,0	4,9	7,00	0083	○	○	○				
M10x1	1,00	90	10	-	7,0	5,5	9,00	0103	○	○	○				
M10x1,25	1,25	100	15	-	7,0	5,5	8,80	0104	○	○	○				
M11x1	1,00	90	10	-	8,0	6,2	10,00	0113	○	○	○				
M12x1	1,00	100	10	-	9,0	7,0	11,00	0123	○	○	○				
M12x1,25	1,25	100	15	-	9,0	7,0	10,80	0124	○	○	○				
M12x1,5	1,50	100	15	-	9,0	7,0	10,50	0125	●	●	○				
M14x1	1,00	100	10	-	11,0	9,0	13,00	0143	○	○	○				
M14x1,25	1,25	100	15	-	11,0	9,0	12,80	0144	○	○	○				
M14x1,5	1,50	100	15	-	11,0	9,0	12,50	0145	●	●	○				
M15x1	1,00	100	10	-	12,0	9,0	14,00	0153	○	○	○				
M16x1	1,00	100	10	-	12,0	9,0	15,00	0163	○	○	○				
M16x1,5	1,50	100	15	-	12,0	9,0	14,50	0165	●	●	○				

ISO	V _c (m/min)					
P	5-50	5-50	5-60			
M	5-20	5-20	5-30			
K	5-40	5-40	5-60			
N	5-40	5-40	5-60			
S	1-8	1-8	1-8			

**Gwint metryczny drobnozwojny
ISO DIN-13**

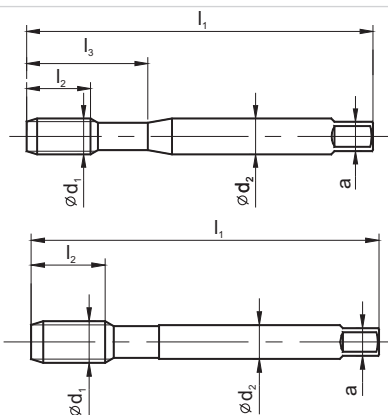
HSS
**DIN
2181**

Rodzaj materiału obrabianego



Typ otworu



Rodzaj materiału

HSS

Rodzaj powłoki

Nakrój

~3P

MF $\varnothing d_1$	P	l_1	l_2	l_3	$\varnothing d_2$	a		Norma	
								DIN-2181	
								Tol.	ISO2 (6H)
								INDEX	E1-131001
M4x0,5	0,50	45	10	18,0	4,5	3,4	3,5	0041	○
M4,5x0,5	0,50	50	12	22,0	6,0	4,9	4,0	0046	○
M5x0,5	0,50	52	13	22,0	6,0	4,9	4,5	0051	○
M5,5x0,5	0,50	56	13	24,0	6,0	4,9	5,0	0056	○
M6x0,75	0,75	56	14	24,0	6,0	4,9	5,2	0062	●
M7x0,75	0,75	56	14	-	6,0	4,9	6,2	0072	○
M8x0,75	0,75	63	14	-	6,0	4,9	7,2	0082	●
M8x1	1,00	63	17	-	6,0	4,9	7,0	0083	●
M9x0,75	0,75	63	14	-	7,0	5,5	8,2	0092	○
M9x1	1,00	63	17	-	7,0	5,5	8,0	0093	○
M10x0,75	0,75	63	18	-	7,0	5,5	9,2	0102	○
M10x1	1,00	63	18	-	7,0	5,5	9,0	0103	●
M10x1,25	1,25	70	22	-	7,0	5,5	8,8	0104	●
M11x0,75	0,75	63	18	-	8,0	6,2	10,2	0112	○
M11x1	1,00	63	18	-	8,0	6,2	10,0	0113	○
M12x1	1,00	70	18	-	9,0	7,0	11,0	0123	●
M12x1,25	1,25	70	20	-	9,0	7,0	10,8	0124	●
M12x1,5	1,50	70	20	-	9,0	7,0	10,5	0125	●
M14x1	1,00	70	18	-	11,0	9,0	13,0	0143	○
M14x1,25	1,25	70	20	-	11,0	9,0	12,8	0144	●
M14x1,5	1,50	70	20	-	11,0	9,0	12,5	0145	●
M15x1	1,00	70	18	-	12,0	9,0	14,0	0153	○
M15x1,5	1,50	70	20	-	12,0	9,0	13,5	0155	○
M16x1	1,00	80	18	-	12,0	9,0	15,0	0163	○
M16x1,25	1,25	80	18	-	18,0	9,0	14,8	0164	○
M16x1,5	1,50	80	22	-	12,0	9,0	14,5	0165	●
M17x1	1,00	80	18	-	12,0	9,0	16,0	0173	○
M17x1,5	1,50	80	22	-	12,0	9,0	15,5	0175	○
M18x1	1,00	80	18	-	14,0	11,0	17,0	0183	○
M18x1,5	1,50	80	22	-	14,0	11,0	16,5	0185	●
M18x2	2,00	80	22	-	14,0	11,0	16,0	0186	○
M20x1	1,00	80	18	-	16,0	12,0	19,0	0203	○

● Dostępne z magazynu

○ Na zapytanie

Przykład zamówienia

 E1-131001-0062
Gwintownik M6x0,75-6H DIN-2181 HSS

ISO	Vc (m/min)			
P	5-20			
M	-			
K	-			
N	-			
S	-			

1

**Gwint metryczny drobnozwojny
ISO DIN-13**

HSS

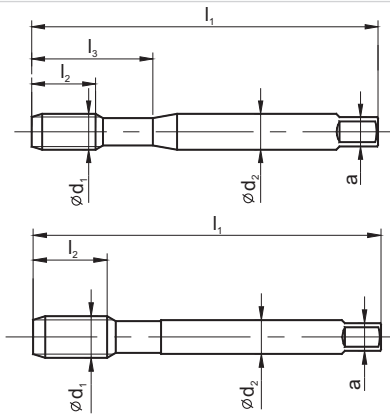
DIN
2181

Rodzaj materiału obrabianego



Typ otworu



Rodzaj materiału

HSS

Rodzaj powłoki

Nakrój

~3P

MF Ød ₁	P	l ₁	l ₂	l ₃	Ød ₂	a		Norma						
								DIN-2181						
								Tol.	ISO2 (6H)					
								INDEX	E1-131001					
M20x1,5	1,50	80	22	-	16	12,0	18,5	0205	●					
M20x2	2,00	80	22	-	16	12,0	18,0	0206	○					
M22x1	1,00	80	18	-	18	14,5	21,0	0223	○					
M22x1,5	1,5	80	22	-	18	14,5	20,5	0225	●					
M22x2	2,0	80	22	-	18	14,5	20,0	0226	○					
M24x1	1,0	90	18	-	18	14,5	23,0	0243	○					
M24x1,5	1,5	90	22	-	18	14,5	22,5	0245	●					
M24x2	2,0	90	22	-	18	14,5	22,0	0246	●					
M25x1	1,0	90	18	-	18	14,5	24,0	0253	○					
M25x1,5	1,5	90	22	-	18	14,5	23,5	0255	●					
M25x2	2,0	90	22	-	18	14,5	23,0	0256	○					
M26x1,5	1,5	90	22	-	18	14,5	24,5	0265	●					
M27x1	1,0	90	20	-	20	16,0	26,0	0273	○					
M27x1,5	1,5	90	22	-	20	16,0	25,5	0275	○					
M27x2	2,0	90	22	-	20	16,0	25,0	0276	○					
M28x1	1,0	90	20	-	20	16,0	27,0	0283	○					
M28x1,5	1,5	90	22	-	20	16,0	26,5	0285	○					
M28x2	2,0	90	22	-	20	16,0	26,0	0286	○					
M30x1	1,0	90	22	-	22	18,0	29,0	0303	○					
M30x1,5	1,5	90	22	-	22	18,0	28,5	0305	●					
M30x2	2,0	90	22	-	22	18,0	28,0	0306	○					
M30x3	3,0	125	36	-	22	18,0	27,0	0307	○					
M32x1,5	1,5	90	22	-	22	18,0	30,5	0325	○					
M32x2	2,0	90	22	-	22	18,0	30,0	0326	○					
M33x1,5	1,5	100	25	-	25	20,0	31,5	0335	○					
M33x2	2,0	100	25	-	25	20,0	31,0	0336	○					
M33x3	3,0	125	36	-	25	20,0	30,0	0337	○					
M35x1,5	1,5	100	25	-	28	22,0	33,5	0355	○					
M36x1,5	1,5	100	25	-	28	22,0	34,5	0365	○					
M36x2	2,0	125	36	-	28	22,0	34,0	0366	○					
M36x3	3,0	125	36	-	28	22,0	33,0	0367	○					
M38x1,5	1,5	100	25	-	28	22,0	36,5	0385	○					









● Dostępne z magazynu

○ Na zapytanie

ISO	Vc (m/min)					
P	5-20					
M	-					
K	-					
N	-					
S	-					

Gwint metryczny drobnozwojny ISO DIN-13												
Rodzaj materiału obrabianego												
Typ otworu												
Rodzaj materiału								HSS				
Rodzaj powłoki												
Nakrój								~3P				
MF $\varnothing d_1$	P	l_1	l_2	l_3	$\varnothing d_2$	a		Norma				
								DIN-2181				
								Tol.	ISO2 (6H)			
								INDEX	E1-131001			
M39x1,5	1,5	110	25	-	32	24	37,5	0395	o			
M39x2	2,0	125	36	-	32	24	37,0	0396	o			
M39x3	3,0	125	36	-	32	24	36,0	0397	o			
M40x1,5	1,5	110	25	-	32	24	38,5	0405	o			
M40x2	2,0	125	36	-	32	24	38,0	0406	o			
M40x3	3,0	125	36	-	32	24	37,0	0407	o			
M42x1,5	1,5	110	25	-	32	24	40,5	0425	o			
M42x2	2,0	125	36	-	32	24	40,0	0426	o			
M42x3	3,0	125	36	-	32	24	39,0	0427	o			
M42x4	4,0	150	50	-	32	24	38,0	0428	o			
M45x1,5	1,5	110	25	-	36	29	43,5	0455	o			
M45x2	2,0	125	36	-	36	29	43,0	0456	o			
M45x3	3,0	125	36	-	36	29	42,0	0457	o			
M45x4	4,0	160	50	-	36	29	41,0	0458	o			
M48x1,5	1,5	140	30	-	36	29	46,5	0485	o			
M48x2	2,0	140	36	-	36	29	46,0	0486	o			
M48x3	3,0	140	36	-	36	29	45,0	0487	o			
M48x4	4,0	180	55	-	36	29	44,0	0488	o			
M50x1,5	1,5	140	30	-	36	29	48,5	0505	o			
M50x2	2,0	140	36	-	36	29	48,0	0506	o			
M50x3	3,0	140	36	-	36	29	47,0	0507	o			
M52x1,5	1,5	140	30	-	40	32	50,5	0525	o			
M52x2	2,0	140	36	-	40	32	50,0	0526	o			
M52x3	3,0	140	40	-	40	32	49,0	0527	o			
M52x4	4,0	180	55	-	40	32	48,0	0528	o			
								ISO				
								Vc (m/min)				
								P	5-20			
								M	-			
								K	-			
								N	-			
								S	-			

1

Gwint metryczny drobnozwojny ISO DIN-13				NUTAP						
				lutowane	skręcane					
  										
Rodzaj materiału obrabianego										
Typ otworu										
Rodzaj materiału				HSSE	HSSE					
Rodzaj powłoki				TS	TS					
Nakrój				12P	12P					
M	P	Wymiary gabarytowe		Na zapytanie						
M8x1	1,0	Na zapytanie	7,0							
M10x1	1,0		9,0							
M12x1	1,0		11,0							
M12x1,5	1,5		10,5							
M14x1,5	1,5		12,5							
M16x1	1,0		15,0							
M16x1,5	1,5		14,5							
M18x1,5	1,5		16,5							
M20x1,5	1,5		18,5							
M20x2	2,0		18,0							
M22x1,5	1,5		20,5							
M22x2	2,0		20,0							
M24x1,5	1,5		22,5							
M24x2	2,0		22,0							
M27x1,5	1,5		25,5							
M27x2	2,0		25,0							
ISO				Vc (m/min)						
P				5-20	5-20					
M				-	-					
K				-	-					
N				-	-					
S				-	-					



Gwint metryczny drobnozwojny ISO DIN-13								NGMf							
								LH							
Rodzaj materiału obrabianego															
Typ otworu															
Rodzaj materiału								HSS	HSS						
Rodzaj powłoki															
Nakrój								12P	12P						
MF Ød ₁	P	l ₁	l ₂	Ød ₂	a		Norma	NGMf							
							Tol.	ISO2 (6H)	ISO2 (6H)						
							INDEX	F1-151001	F1-251001						
M4,5x0,5	0,50	100	10	3,15	2,5	4,0	0046	○	○						
M5x0,5	0,50	110	10	3,55	2,8	4,5	0051	○	○						
M5,5x0,5	0,50	110	10	4,5	3,55	5,0	0056	○	○						
M6x0,75	0,75	120	16	4,5	3,55	5,2	0062	○	○						
M7x0,75	0,75	120	16	5,6	4,5	6,2	0072	○	○						
M8x0,75	0,75	140	16	6,3	5,0	7,2	0082	○	○						
M8x1	1,00	140	20	6,3	5,0	7,0	0083	●	○						
M10x0,75	0,75	160	16	8,0	6,3	9,2	0102	○	○						
M10x1	1,00	160	20	8,0	6,3	9,0	0103	●	○						
M10x1,25	1,25	160	25	8,0	6,3	8,8	0104	●	○						
M12x1	1,00	180	20	9,0	7,1	11,0	0123	●	○						
M12x1,25	1,25	180	25	9,0	7,1	10,8	0124	●	○						
M12x1,5	1,50	180	30	9,0	7,1	10,5	0125	●	○						
M14x1	1,00	180	20	10,0	8,0	13,0	0143	○	○						
M14x1,25	1,25	180	25	10,0	8,0	12,8	0144	●	○						
M14x1,5	1,50	180	30	10,0	8,0	12,5	0145	●	○						
M15x1	1,00	180	20	12,5	10,0	14,0	0153	○	○						
M15x1,5	1,50	180	30	12,5	10,0	13,5	0155	○	○						
M16x1	1,00	200	20	12,5	10,0	15,0	0163	○	○						
M16x1,5	1,50	200	30	12,5	10,0	14,5	0165	●	○						
M17x1	1,00	200	20	14,0	11,2	16,0	0173	○	○						
M17x1,5	1,50	200	30	14,0	11,2	15,5	0175	○	○						
M18x1	1,00	200	20	14,0	11,2	17,0	0183	○	○						
M18x1,5	1,50	200	30	14,0	11,2	16,5	0185	○	○						
M18x2	2,00	200	40	14,0	11,2	16,0	0186	○	○						
M20x1	1,00	220	20	16,0	12,5	19,0	0203	○	○						
M20x1,5	1,50	220	30	16,0	12,5	18,5	0205	●	○						
M20x2	2,00	220	40	16,0	12,5	18,0	0206	○	○						
M22x1	1,00	220	20	18,0	14,0	21,0	0223	○	○						
M22x1,5	1,50	220	30	18,0	14,0	20,5	0225	○	○						
M22x2	2,00	220	40	18,0	14,0	20,0	0226	○	○						
M24x1	1,00	250	20	18,0	14,0	23,0	0243	○	○						

	Vc (m/min)			
● Dostępne z magazynu	ISO			
○ Na zapytanie	P	5-20	5-20	
	M	-	-	
	K	6-15	6-15	
	N	6-15	6-15	
	S	-	-	

Przykład zamówienia
 F1-151001-0083
 Gwintownik M8x1-6H NGMf HSS

1

**Gwint metryczny drobnozwojny
ISO DIN-13**

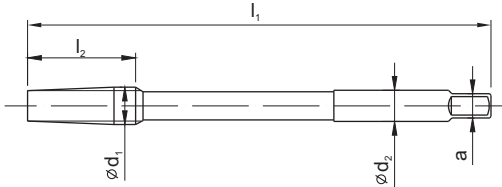

HSS

NGMf

LH

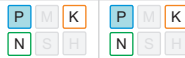

Rodzaj materiału obrabianego



Typ otworu



Rodzaj materiału

HSS HSS

Rodzaj powłoki

Nakrój

12P 12P

MF $\varnothing d_1$	P	l_1	l_2	$\varnothing d_2$	a		Norma	NGMf					
							Tol.	ISO2 (6H)	ISO2 (6H)				
							INDEX	F1-151001	F1-251001				
M24x1,5	1,50	250	30	18,0	14,0	22,5	0245	o	o				
M24x2	2,00	250	40	18,0	14,0	22,0	0246	o	o				
M25x1	1,00	250	20	20,0	16,0	24,0	0253	o	o				
M25x1,5	1,50	250	30	20,0	16,0	23,5	0255	o	o				
M25x2	2,00	250	40	20,0	16,0	23,0	0256	o	o				
M26x1,5	1,50	250	30	20,0	16,0	24,5	0265	o	o				
M27x1	1,00	250	20	20,0	16,0	26,0	0273	o	o				
M27x1,5	1,50	250	30	20,0	16,0	25,5	0275	o	o				
M27x2	2,00	250	40	20,0	16,0	25,0	0276	o	o				
M28x1	1,00	250	20	22,4	18,0	27,0	0283	o	o				
M28x1,5	1,50	250	30	22,4	18,0	26,5	0285	o	o				
M28x2	2,00	250	40	22,4	18,0	26,0	0286	o	o				
M30x1	1,00	280	20	22,4	18,0	29,0	0303	o	o				
M30x1,5	1,50	280	30	22,4	18,0	28,5	0305	o	o				
M30x2	2,00	280	40	22,4	18,0	28,0	0306	o	o				
M30x3	3,00	280	60	22,4	18,0	27,0	0307	o	o				
M32x1,5	1,50	280	30	25,0	20,0	30,5	0325	o	o				
M32x2	2,00	280	40	25,0	20,0	30,0	0326	o	o				
M33x1,5	1,50	280	30	25,0	20,0	31,5	0335	o	o				
M33x2	2,00	280	40	25,0	20,0	31,0	0336	o	o				
M33x3	3,00	280	60	25,0	20,0	30,0	0337	o	o				
M35x1,5	1,50	280	30	28,0	22,4	33,5	0355	o	o				
M36x1,5	1,50	280	30	28,0	22,4	34,5	0365	o	o				
M36x2	2,00	280	40	28,0	22,4	34,0	0366	o	o				
M36x3	3,00	280	60	28,0	22,4	33,0	0367	o	o				

ISO	Vc (m/min)					
P	5-20	5-20				
M	-	-				
K	6-15	6-15				
N	6-15	6-15				
S	-	-				



MASTER TAP

Gwint amerykański zunifikowany UNC, ANSI B-1.1											MASTER TAP					
											B-HL	C-R45-HL				
Rodzaj materiału obrabianego																
Typ otworu																
Rodzaj materiału											HSSE-PM HSSE-PM					
Rodzaj powłoki											HL HL					
Nakrój											B / 4-5P C / 2-3P					
UNC	Ød ₁	1"/P	P	l ₁	l ₂	l ₃	Ød ₂	a		Norma	DIN-371					
										Tol.	2BX	2BX				
										INDEX	C4-118M01	C4-528M01				
No2-56	2,184	56	0,455	45	10	13	2,8	2,1	1,85	4102	○	○				
No4-40	2,844	40	0,635	56	5	18	3,5	2,7	2,35	4104	●	●				
No5-40	3,175	40	0,635	56	7	18	3,5	2,7	2,65	4105	●	●				
No6-32	3,505	32	0,794	56	6	20	4,0	3,0	2,85	4106	●	●				
No8-32	4,165	32	0,794	63	7	21	4,5	3,4	3,50	4108	●	●				
No10-24	4,826	24	1,058	70	8	25	6,0	4,9	3,90	4110	●	●				
No12-24	5,486	24	1,058	80	10	30	6,0	4,9	4,50	4112	●	●				
1/4-20	6,350	20	1,270	80	13	32	7,0	5,5	5,10	4127	●	●				
5/16-18	7,938	18	1,411	90	13	35	8,0	6,2	6,60	4128	●	●				
3/8-16	9,525	16	1,588	100	15	39	10,0	8,0	8,00	4129	●	●				
UNC	Ød ₁	1"/P	P	l ₁	l ₂	l ₃	Ød ₂	a		Norma	DIN-376					
										Tol.	2BX	2BX				
										INDEX	D4-118M01	D4-528M01				
7/16-14	11,112	14	1,814	100	15	-	8,0	6,2	9,40	4130	●	●				
1/2-13	12,700	13	1,954	110	18	-	9,0	7,0	10,80	4131	●	●				
9/16-12	14,288	12	2,117	110	20	-	11,0	9,0	12,20	4132	●	●				
5/8-11	15,875	11	2,309	110	22	-	12,0	9,0	13,50	4133	●	●				
ISO											Vc (m/min)					
P											5-40	5-40				
M											5-15	5-15				
K											10-30	10-30				
N											10-30	10-30				
S											1-8	1-8				

1

**Gwint amerykański zunifikowany
UNC, ANSI B-1.1**



HSSE

TN2

DIN 371

DIN 376

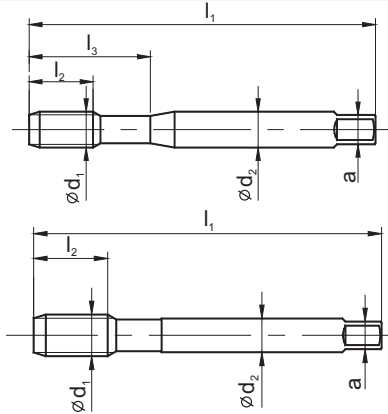

800X

B-TN2 C-R40-TN2



Rodzaj materiału obrabianego



Typ otworu



Rodzaj materiału

HSSE HSSE

Rodzaj powłoki

TN2 TN2

Nakrój

B / 4-5P C / 2-3P

UNC	Ød ₁	1"/P	P	l ₁	l ₂	l ₂ R40	l ₃	Ød ₂	a		Norma	DIN-371	
											Tol.	2B	2B
											INDEX	C2-113X01	C2-513X01
No2-56	2,184	56	0,455	45	10	10	13	2,8	2,1	1,85	4102	○	○
No4-40	2,844	40	0,635	56	10	5	18	3,5	2,7	2,35	4104	●	●
No5-40	3,175	40	0,635	56	10	7	18	3,5	2,7	2,65	4105	●	●
No6-32	3,505	32	0,794	56	12	6	20	4,0	3,0	2,85	4106	●	●
No8-32	4,165	32	0,794	63	12	7	21	4,5	3,4	3,50	4108	●	●
No10-24	4,826	24	1,058	70	14	8	25	6,0	4,9	3,90	4110	●	●
No12-24	5,486	24	1,058	80	18	10	30	6,0	4,9	4,50	4112	●	●
1/4-20	6,350	20	1,270	80	18	13	32	7,0	5,5	5,10	4127	●	●
5/16-18	7,938	18	1,411	90	20	13	35	8,0	6,2	6,60	4128	●	●
3/8-16	9,525	16	1,588	100	20	15	39	10,0	8,0	8,00	4129	●	●

UNC	Ød ₁	1"/P	P	l ₁	l ₂	l ₂ R40	l ₃	Ød ₂	a		Norma	DIN-376	
											Tol.	2B	2B
											INDEX	D2-113X01	D2-513X01
7/16-14	11,112	14	1,814	100	22	15	-	8,0	6,2	9,40	4130	●	●
1/2-13	12,700	13	1,954	110	24	18	-	9,0	7,0	10,80	4131	●	●
9/16-12	14,288	12	2,117	110	25	20	-	11,0	9,0	12,20	4132	●	●
5/8-11	15,875	11	2,309	110	32	22	-	12,0	9,0	13,50	4133	●	●
3/4-10	19,050	10	2,540	125	32	25	-	14,0	11,0	16,50	4135	●	●
7/8-9	22,225	9	2,822	140	32	30	-	18,0	14,5	19,50	4137	●	●
1-8	25,400	8	3,175	160	38	30	-	20,0	16,0	22,25	4139	●	●
1.1/8-7	28,575	7	3,629	180	45	37	-	22,0	18,0	25,00	4141	○	○
1.1/4-7	31,750	7	3,629	180	45	37	-	22,0	18,0	28,00	4143	○	○
1.3/8-6	34,925	6	4,233	200	50	40	-	28,0	22,0	30,75	4145	○	○
1.1/2-6	38,100	6	4,233	200	55	40	-	28,0	22,0	34,00	4147	○	○

ISO	Vc (m/min)		
P	5-35	5-35	
M	5-15	5-15	
K	5-25	5-25	
N	10-30	10-30	
S	-	-	

800X

Gwint amerykański zunifikowany UNC, ANSI B-1.1											800						
											B	C-R40					
Rodzaj materiału obrabianego																	
Typ otworu																	
Rodzaj materiału											HSSE						
Rodzaj powłoki																	
Nakrój											B / 4-5P C / 2-3P						
UNC	Ød ₁	1"/P	P	l ₁	l ₂	l ₂ R40	l ₃	Ød ₂	a		Norma						
											DIN-371						
											Tol.	2B	2B				
											INDEX	C2-111101	C2-511101				
No2-56	2,184	56	0,455	45	10	10	13	2,8	2,1	1,85	4102	○	○				
No4-40	2,844	40	0,635	56	10	5	18	3,5	2,7	2,35	4104	●	●				
No5-40	3,175	40	0,635	56	10	7	18	3,5	2,7	2,65	4105	●	●				
No6-32	3,505	32	0,794	56	12	6	20	4,0	3,0	2,85	4106	●	●				
No8-32	4,165	32	0,794	63	12	7	21	4,5	3,4	3,50	4108	●	●				
No10-24	4,826	24	1,058	70	14	8	25	6,0	4,9	3,90	4110	●	●				
No12-24	5,486	24	1,058	80	18	10	30	6,0	4,9	4,50	4112	●	●				
1/4-20	6,350	20	1,270	80	18	13	32	7,0	5,5	5,10	4127	●	●				
5/16-18	7,938	18	1,411	90	20	13	35	8,0	6,2	6,60	4128	●	●				
3/8-16	9,525	16	1,588	100	20	15	39	10,0	8,0	8,00	4129	●	●				
UNC	Ød ₁	1"/P	P	l ₁	l ₂	l ₂ R40	l ₃	Ød ₂	a		Norma						
											DIN-376						
											Tol.	2B	2B				
											INDEX	D2-111101	D2-511101				
7/16-14	11,112	14	1,814	100	22	15	-	8,0	6,2	9,40	4130	●	●				
1/2-13	12,700	13	1,954	110	24	18	-	9,0	7,0	10,80	4131	●	●				
9/16-12	14,288	12	2,117	110	25	20	-	11,0	9,0	12,20	4132	●	●				
5/8-11	15,875	11	2,309	110	32	22	-	12,0	9,0	13,50	4133	●	●				
3/4-10	19,050	10	2,540	125	32	25	-	14,0	11,0	16,50	4135	●	●				
7/8-9	22,225	9	2,822	140	32	30	-	18,0	14,5	19,50	4137	●	●				
1-8	25,400	8	3,175	160	38	30	-	20,0	16,0	22,25	4139	●	●				
1.1/8-7	28,575	7	3,629	180	45	37	-	22,0	18,0	25,00	4141	●	●				
1.1/4-7	31,750	7	3,629	180	45	37	-	22,0	18,0	28,00	4143	●	●				
1.3/8-6	34,925	6	4,233	200	50	40	-	28,0	22,0	30,75	4145	●	●				
1.1/2-6	38,100	6	4,233	200	55	40	-	28,0	22,0	34,00	4147	●	●				
											ISO		Vc (m/min)				
											P	5-20	5-20				
											M	5-10	5-10				
											K	5-15	5-15				
											N	5-25	5-25				
											S	-	-				

1

**Gwint amerykański zunifikowany
UNC, ANSI B-1.1**

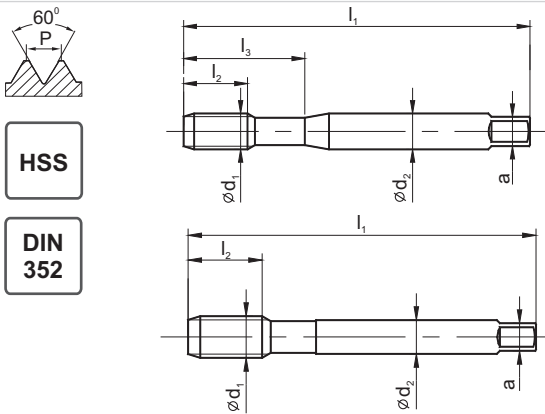

Rodzaj materiału obrabianego



Typ otworu



Rodzaj materiału

HSS

Rodzaj powłoki

Nakrój

~3P

UNC	Ød ₁	1"/P	P	l ₁	l ₂	l ₃	Ød ₂	a		Norma					
										DIN-352					
										Toł.	2B				
										INDEX	E1-131001				
No4-40	2,844	40	0,635	40	10	18	3,5	2,7	2,35	4104	○				
No5-40	3,175	40	0,640	42	10	18	3,5	2,7	2,65	4105	○				
No6-32	3,505	32	0,794	45	11	18	4,0	3,0	2,85	4106	●				
No8-32	4,166	32	0,794	48	12	23	4,5	3,4	3,50	4108	○				
No10-24	4,826	24	1,060	52	14	26	6,0	4,9	3,90	4110	○				
No12-24	5,486	24	1,060	56	16	27	6,0	4,9	4,50	4112	○				
1/4-20	6,350	20	1,270	56	16	27	6,0	4,9	5,20	4127	●				
5/16-18	7,938	18	1,411	63	20	-	6,0	4,9	6,60	4128	●				
3/8-16	9,525	16	1,588	70	22	-	7,0	5,5	8,00	4129	●				
7/16-14	11,112	14	1,814	70	22	-	8,0	6,2	9,40	4130	○				
1/2-13	12,700	13	1,954	80	25	-	9,0	7,0	10,80	4131	●				
9/16-12	14,288	12	2,117	80	26	-	11,0	9,0	12,20	4132	○				
5/8-11	15,875	11	2,309	80	27	-	12,0	9,0	13,50	4133	●				
3/4-10	19,050	10	2,540	95	30	-	14,0	11,0	16,50	4135	●				
7/8-9	22,225	9	2,822	100	32	-	18,0	14,5	19,50	4137	○				
1-8	25,400	8	3,175	110	36	-	18,0	14,5	22,25	4139	○				
1.1/8-7	28,575	7	3,629	125	40	-	22,0	18,0	25,00	4141	○				
1.1/4-7	31,750	7	3,629	125	40	-	22,0	18,0	28,00	4143	○				
1.3/8-6	34,925	6	4,233	150	50	-	28,0	22,0	30,75	4145	○				
1.1/2-6	38,100	6	4,233	150	50	-	28,0	22,0	34,00	4147	○				
1.3/4-5	44,450	5	5,080	160	58	-	36,0	29,0	39,50	4151	○				
2-4.1/2	50,800	4 1/2	5,644	180	65	-	40,0	32,0	45,00	4155	○				

ISO		Vc (m/min)			
P	5-20				
M	-				
K	-				
N	-				
S	-				



Gwint amerykański zunifikowany drobnozwojny UNF, ANSI B-1.1										MASTER TAP						
										B-HL	C-R45-HL					
Rodzaj materiału obrabianego																
Typ otworu																
Rodzaj materiału										HSSE-PM HSSE-PM						
Rodzaj powłoki										HL HL						
Nakrój										B / 4-5P C / 2-3P						
UNF	Ød ₁	1"/P	P	l ₁	l ₂	l ₃	Ød ₂	a		Norma			DIN-371			
													2BX		2BX	
										INDEX			C4-118M01		C4-528M01	
No4-48	2,844	48	0,529	56	5	18	3,5	2,7	2,40	4204	●	●				
No5-44	3,175	44	0,557	56	7	18	3,5	2,7	2,70	4205	●	●				
No6-40	3,505	40	0,635	56	6	20	4,0	3,0	2,95	4206	●	●				
No8-36	4,165	36	0,706	63	7	21	4,5	3,4	3,50	4208	●	●				
No10-32	4,826	32	0,794	70	8	25	6,0	4,9	4,10	4210	●	●				
No12-28	5,486	28	0,907	80	10	30	6,0	4,9	4,60	4212	●	●				
1/4-28	6,350	28	0,907	80	10	30	7,0	5,5	5,50	4227	●	●				
5/16-24	7,938	24	1,058	90	13	35	8,0	6,2	6,90	4228	●	●				
3/8-24	9,525	24	1,058	90	15	35	10,0	8,0	8,50	4229	●	●				
UNF	Ød ₁	1"/P	P	l ₁	l ₂	l ₃	Ød ₂	a		Norma			DIN-374			
													2BX		2BX	
										INDEX			D4-118M01		D4-528M01	
7/16-20	11,112	20	1,270	100	15	-	8,0	6,2	9,90	4230	●	●				
1/2-20	12,700	20	1,270	100	15	-	9,0	7,0	11,50	4231	●	●				
9/16-18	14,288	18	1,411	100	15	-	11,0	9,0	12,90	4232	●	●				
5/8-18	15,875	18	1,411	100	15	-	12,0	9,0	14,50	4233	●	●				
										ISO		Vc (m/min)				
										P	5-40	5-40				
										M	5-15	5-15				
										K	10-30	10-30				
										N	10-30	10-30				
										S	1-8	1-8				

MASTER TAP

1

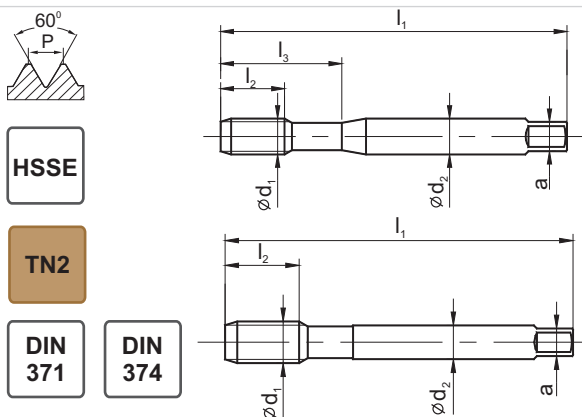
**Gwint amerykański zunifikowany
drobnozwojny UNF, ANSI B-1.1**

HSSE

TN2

DIN
371DIN
374**800X**

B-TN2

C-R40-TN2



Rodzaj materiału obrabianego

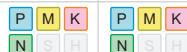

Typ otworu



Rodzaj materiału

HSSE

HSSE

Rodzaj powłoki

TN2

TN2

Nakrój

B / 4-5P

C / 2-3P

UNF	Ød ₁	1"/P	P	l ₁	l ₂	l ₂ R40	l ₃	Ød ₂	a		Norma					
											DIN-371					
											Tol.	2B	2B			
INDEX																
												C2-113X01	C2-513X01			
No6-40	3,505	40	0,635	56	12	6	20	4,0	3,0	2,95	4206	○	○			
No8-36	4,165	36	0,706	63	12	7	21	4,5	3,4	3,50	4208	○	○			
No10-32	4,826	32	0,794	70	14	8	25	6,0	4,9	4,10	4210	●	●			
No12-28	5,486	28	0,907	80	18	10	30	6,0	4,9	4,60	4212	●	●			
1/4-28	6,350	28	0,907	80	18	10	30	7,0	5,5	5,50	4227	●	●			
5/16-24	7,938	24	1,058	90	20	13	35	8,0	6,2	6,90	4228	●	●			
3/8-24	9,525	24	1,058	90	20	15	35	10,0	8,0	8,50	4229	●	●			

UNF	Ød ₁	1"/P	P	l ₁	l ₂	l ₂ R40	l ₃	Ød ₂	a		Norma					
											DIN-374					
											Tol.	2B	2B			
INDEX																
												D2-113X01	D2-513X01			
7/16-20	11,112	20	1,270	100	20	15	-	8,0	6,2	9,90	4230	●	●			
1/2-20	12,700	20	1,270	100	20	15	-	9,0	7,0	11,50	4231	●	●			
9/16-18	14,288	18	1,411	100	20	15	-	11,0	9,0	12,90	4232	●	●			
5/8-18	15,875	18	1,411	100	20	15	-	12,0	9,0	14,50	4233	●	●			
3/4-16	19,050	16	1,588	110	24	17	-	14,0	11,0	17,50	4235	●	●			
7/8-14	22,225	14	1,814	125	24	17	-	18,0	14,5	20,40	4237	●	●			
1-12	25,400	12	2,117	140	27	22	-	18,0	14,5	23,25	4239	●	●			
1.1/8-12	28,575	12	2,117	150	27	22	-	22,0	18,0	26,50	4241	○	○			
1.1/4-12	31,750	12	2,117	150	27	22	-	22,0	18,0	29,50	4243	○	○			
1.3/8-12	34,925	12	2,117	170	30	22	-	28,0	22,0	32,75	4245	○	○			
1.1/2-12	38,100	12	2,117	170	30	24	-	28,0	22,0	36,00	4247	○	○			

ISO	V _c (m/min)				
P	5-35	5-35			
M	5-15	5-15			
K	5-25	10-25			
N	10-30	10-30			
S	-	-			

Przykład zamawiania

C2-113X01-4208
Gwintownik 800X No8-36 UNF 2B DIN-371 B HSSE TN2

- Dostępne z magazynu
- Na zapytanie

Gwint amerykański zunifikowany drobnozwojny UNF, ANSI B-1.1												800					
												B	C-R40				
Rodzaj materiału obrabianego																	
Typ otworu																	
Rodzaj materiału												HSSE					
Rodzaj powłoki																	
Nakrój												B / 4-5P		C / 2-3P			
UNF	Ød ₁	1"/P	P	l ₁	l ₂	l ₂ R40	l ₃	Ød ₂	a		Norma	DIN-371					
											Tol.	2B	2B				
											INDEX	C2-111101	C2-511101				
No6-40	3,505	40	0,635	56	12	6	20	4,0	3,0	2,95	4206	○	○				
No8-36	4,165	36	0,706	63	12	7	21	4,5	3,4	3,50	4208	○	○				
No10-32	4,826	32	0,794	70	14	8	25	6,0	4,9	4,10	4210	●	●				
No12-28	5,486	28	0,907	80	18	10	30	6,0	4,9	4,60	4212	●	●				
1/4-28	6,350	28	0,907	80	18	10	30	7,0	5,5	5,50	4227	●	●				
5/16-24	7,938	24	1,058	90	20	13	35	8,0	6,2	6,90	4228	●	●				
3/8-24	9,525	24	1,058	90	20	15	35	10,0	8,0	8,50	4229	●	●				

UNF	Ød ₁	1"/P	P	l ₁	l ₂	l ₂ R40	l ₃	Ød ₂	a		Norma	DIN-374						
											Tol.	2B	2B					
											INDEX	D2-111101	D2-511101					
7/16-20	11,112	20	1,270	100	20	15	-	8,0	6,2	9,90	4230	●	●					
1/2-20	12,700	20	1,270	100	20	15	-	9,0	7,0	11,50	4231	●	●					
9/16-18	14,288	18	1,411	100	20	15	-	11,0	9,0	12,90	4232	●	●					
5/8-18	15,875	18	1,411	100	20	15	-	12,0	9,0	14,50	4233	●	●					
3/4-16	19,050	16	1,588	110	24	17	-	14,0	11,0	17,50	4235	●	●					
7/8-14	22,225	14	1,814	125	24	17	-	18,0	14,5	20,40	4237	●	●					
1-12	25,400	12	2,117	140	27	22	-	18,0	14,5	23,25	4239	●	●					
1.1/8-12	28,575	12	2,117	150	27	22	-	22,0	18,0	26,50	4241	○	○					
1.1/4-12	31,750	12	2,117	150	27	22	-	22,0	18,0	29,50	4243	○	○					
1.3/8-12	34,925	12	2,117	170	30	22	-	28,0	22,0	32,75	4245	○	○					
1.1/2-12	38,100	12	2,117	170	30	24	-	28,0	22,0	36,00	4247	○	○					
												ISO			V _c (m/min)			
												P	5-20	5-20				
												M	5-10	5-10				
												K	5-15	5-15				
												N	5-25	5-25				
												S	-	-				

1

**Gwint amerykański zunifikowany
drobnozwojny UNF, ANSI B-1.1**

HSS

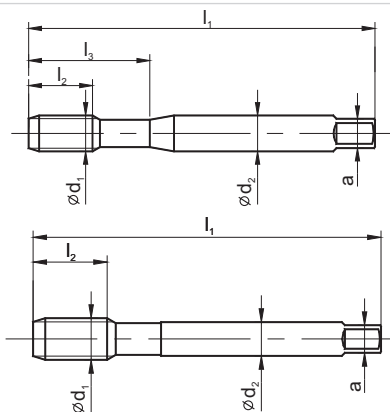
DIN
2181

Rodzaj materiału obrabianego



Typ otworu



Rodzaj materiału

HSS

Rodzaj powłoki

Nakrój

~3P

UNF	Ød ₁	1"/P	P	l ₁	l ₂	l ₃	Ød ₂	a		Norma						
										DIN-2181						
										Tol.	2B					
										INDEX	E1-131001					
No5-44	3,175	44	0,577	42	10	18	3,5	2,7	2,70	4205	○					
No6-40	3,505	40	0,635	45	11	18	4,0	3,0	2,95	4206	○					
No8-36	4,165	36	0,706	48	12	23	4,5	3,4	3,50	4208	○					
No10-32	4,826	32	0,794	52	14	22	6,0	4,9	4,10	4210	○					
No12-28	5,486	28	0,907	56	16	24	6,0	4,9	4,60	4212	○					
1/4-28	6,350	28	0,907	56	16	24	6,0	4,9	5,50	4227	●					
5/16-24	7,938	24	1,058	63	17	-	6,0	4,9	6,90	4228	●					
3/8-24	9,525	24	1,058	63	18	-	7,0	5,5	8,50	4229	●					
7/16-20	11,112	20	1,270	70	22	-	8,0	6,2	9,90	4230	●					
1/2-20	12,700	20	1,270	70	20	-	9,0	7,0	11,50	4231	●					
9/16-18	14,288	18	1,411	80	20	-	11,0	9,0	12,90	4232	●					
5/8-18	15,875	18	1,411	80	20	-	12,0	9,0	14,50	4233	●					
3/4-16	16,050	16	1,588	80	22	-	14,0	11,0	17,50	4235	●					
7/8-14	22,225	14	1,814	80	22	-	18,0	14,5	20,40	4237	○					
1-12	25,400	12	2,117	90	22	-	18,0	14,5	23,25	4239	○					
1.1/8-12	28,575	12	2,117	90	22	-	22,0	18,0	26,50	4241	○					
1.1/4-12	31,750	12	2,117	90	22	-	22,0	18,0	29,50	4243	○					
1.3/8-12	34,925	12	2,117	125	36	-	28,0	22,0	32,75	4245	○					
1.1/2-12	38,100	12	2,117	125	36	-	28,0	22,0	36,00	4247	○					

ISO	V _c (m/min)				
P	5-20				
M	-				
K	-				
N	-				
S	-				



Gwint amerykański zunifikowany drobnozwojny UNEF, ANSI B-1.1												800X							
												B-TN2	C-R40-TN2						
Rodzaj materiału obrabianego																			
Typ otworu																			
Rodzaj materiału												HSSE							
Rodzaj powłoki												TN2							
Nakrój												B / 4-5P		C / 2-3P					
UNEF	Ød ₁	1"/P	P	l ₁	l ₂	l ₂ R40	l ₃	Ød ₂	a		Norma	~DIN-374							
											Tol.	2B	2B						
											INDEX	D2-113X01	D2-513X01						
1/4-32	6,350	32	0,794	80	14	8	-	4,5	3,4	5,55	4327	o	o						
5/16-32	7,938	32	0,794	80	14	8	-	6,0	4,9	7,15	4328	o	o						
3/8-32	9,525	32	0,794	90	18	8	-	7,0	5,5	8,70	4329	o	o						
7/16-28	11,112	28	0,907	90	18	10	-	8,0	6,2	10,20	4330	o	o						
1/2-28	12,700	28	0,907	100	18	10	-	9,0	7,0	11,80	4331	o	o						
9/16-24	14,288	24	1,058	100	18	11	-	11,0	9,0	13,20	4332	o	o						
5/8-24	15,875	24	1,058	100	18	11	-	12,0	9,0	14,80	4333	o	o						
3/4-20	19,050	20	1,270	110	25	13	-	14,0	11,0	17,80	4335	o	o						
7/8-20	22,225	20	1,270	125	25	13	-	18,0	14,5	20,95	4337	o	o						
1-20	25,400	20	1,270	140	28	13	-	18,0	14,5	24,15	4339	o	o						
												ISO		V _c (m/min)					
												P	5-35	5-35					
												M	5-15	5-15					
												K	5-25	10-25					
												N	10-30	10-30					
												S	-	-					

1

Gwint amerykański zunifikowany drobnozwojny UNEF, ANSI B-1.1



HSSE
DIN ~374

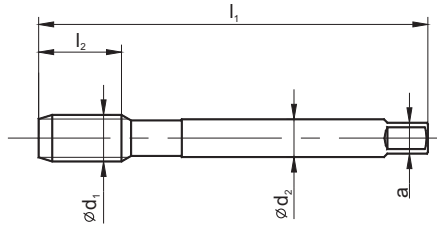

800

B

C-R40



Rodzaj materiału obrabianego

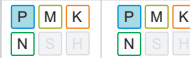

Typ otworu



Rodzaj materiału

HSSE HSSE

Rodzaj powłoki

Nakrój

B / 4-5P C / 2-3P

UNEF	Ød ₁	1"/P	P	l ₁	l ₂	l ₂ R40	l ₃	Ød ₂	a		Norma		~DIN-374					
											Tol.	2B		2B				
											INDEX	D2-111101	D2-511101					
1/4-32	6,350	32	0,794	80	14	8	-	4,5	3,4	5,55	4327	o	o					
5/16-32	7,938	32	0,794	80	14	8	-	6,0	4,9	7,15	4328	o	o					
3/8-32	9,525	32	0,794	90	18	8	-	7,0	5,5	8,70	4329	o	o					
7/16-28	11,112	28	0,907	90	18	10	-	8,0	6,2	10,20	4330	o	o					
1/2-28	12,700	28	0,907	100	18	10	-	9,0	7,0	11,80	4331	o	o					
9/16-24	14,288	24	1,058	100	18	11	-	11,0	9,0	13,20	4332	o	o					
5/8-24	15,875	24	1,058	100	18	11	-	12,0	9,0	14,80	4333	o	o					
3/4-20	19,050	20	1,270	110	25	13	-	14,0	11,0	17,80	4335	o	o					
7/8-20	22,225	20	1,270	125	25	13	-	18,0	14,5	20,95	4337	o	o					
1-20	25,400	20	1,270	140	28	13	-	18,0	14,5	24,15	4339	o	o					

ISO	V _c (m/min)		
P	5-20	5-20	
M	5-10	5-10	
K	5-15	5-15	
N	5-25	5-25	
S	-	-	



Gwint amerykański zunifikowany przeznaczony do lotnictwa UNJC ASME B1.15										1400-HT					
										B-TS	C-R15-TS				
Rodzaj materiału obrabianego															
Typ otworu															
Rodzaj materiału										HSSE-PM HSSE-PM					
Rodzaj powłoki										TS TS					
Nakrój										B / 4-5P C / 2-3P					
UNJC	$\varnothing d_1$	P	l_1	l_2	l_3	$\varnothing d_2$	a		Norma	DIN-371					
									Tol.	3BX	3BX				
									INDEX	C4-11G902	C4-50G902				
No4-40	2,844	40	56	10	18	3,5	2,7	2,35	4004	o	o				
No6-32	3,505	32	56	12	20	4,0	3,0	2,85	4006	o	o				
No8-32	4,165	32	63	12	21	4,5	3,4	3,50	4008	o	o				
No10-24	4,826	24	70	14	25	6,0	4,9	3,90	4010	o	o				
1/4-20	6,350	20	80	18	32	7,0	5,5	5,10	4027	o	o				
5/16-18	7,938	18	90	20	35	8,0	6,0	6,60	4028	o	o				
3/8-16	9,525	16	100	20	39	10,0	8,0	8,00	4029	o	o				
UNJC	$\varnothing d_1$	P	l_1	l_2	l_3	$\varnothing d_2$	a		Norma	DIN-376					
									Tol.	3BX	3BX				
									INDEX	D4-11G902	D4-50G902				
7/16-14	11,112	14	100	22	-	8,0	6,2	9,40	4030	o	o				

1

Gwint amerykański zunifikowany drobnozwojny przeznaczony do lotnictwa UNJF ASME B1.15

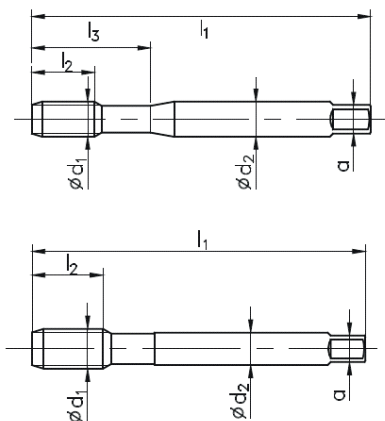
**HSSE
PM**
TS

1400-HT

B-TS

C-R15-TS



Rodzaj materiału obrabianego



Typ otworu



Rodzaj materiału

HSSE-PM HSSE-PM

Rodzaj powłoki

TS TS

Nakrój

B / 4-5P C / 2-3P

UNJF	$\varnothing d_1$	P	l_1	l_2	l_3	$\varnothing d_2$	a		Norma		DIN-371	
									Tol.		3BX	3BX
									INDEX		C4-11G902	C4-50G902
No6-40	3,505	40	56	12	20	4,0	3,0	2,95	4906	o	o	
No8-36	4,165	36	63	12	21	4,5	3,4	3,50	4908	o	o	
No10-32	4,826	32	70	14	25	6,0	4,9	4,10	4910	o	o	
1/4-28	6,350	28	80	18	32	7,0	5,5	5,50	4927	o	o	
5/16-24	7,938	24	90	20	35	8,0	6,0	6,90	4928	o	o	
3/8-24	9,525	24	100	20	39	10,0	8,0	8,50	4929	o	o	

UNJF	$\varnothing d_1$	P	l_1	l_2	l_3	$\varnothing d_2$	a		Norma		DIN-374	
									Tol.		3BX	3BX
									INDEX		D4-11G902	D4-50G902
7/16-20	11,112	20	100	20	-	8,0	6,2	9,40	4930	o	o	



Gwint rurowy walcowy G, DIN-ISO 228										MASTER TAP					
										B-HL	C-R45-HL				
HSSE PM HL DIN 5156															
Rodzaj materiału obrabianego															
Typ otworu															
Rodzaj materiału										HSSE-PM	HSSE-PM				
Rodzaj powłoki										HL	HL				
Nakrój										B / 4-5P	C / 2-3P				
G	Ød ₁	1"/P	P	l ₁	l ₂	l ₃	Ød ₂	a		Norma					
										DIN-5156					
										Tol.					
										INDEX	D4-118M01	D4-528M01			
G1/16	7,723	28	0,907	90	10	-	6,0	4,9	6,80	3121	○	○			
G1/8	9,728	28	0,907	90	10	-	7,0	5,5	8,80	3123	●	●			
G1/4	13,157	19	1,337	100	14	-	11,0	9,0	11,80	3127	●	●			
G3/8	16,662	19	1,337	100	15	-	12,0	9,0	15,25	3129	●	●			
G1/2	20,955	14	1,814	125	17	-	16,0	12,0	19,00	3131	●	●			
G5/8	22,911	14	1,814	125	20	-	18,0	14,5	21,00	3133	●	●			
G3/4	26,441	14	1,814	140	20	-	20,0	16,0	24,50	3135	●	●			
G7/8	30,201	14	1,814	150	22	-	22,0	18,0	28,25	3137	●	●			
G1	33,249	11	2,309	160	24	-	25,0	20,0	30,75	3139	●	●			
										ISO		Vc (m/min)			
										P	10-40	10-40			
										M	5-15	5-15			
										K	10-30	10-30			
										N	10-50	10-50			
										S	1-8	1-8			

MASTER TAP

1

Gwint rurowy walcowy G, DIN-ISO 228



HSSE

TN2

DIN 5156

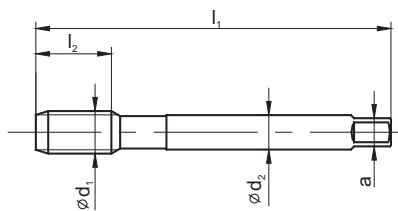

800X

C-TN2

B-TN2

C-R40-TN2



Rodzaj materiału obrabianego

P M K
N S HP M K
N S HP M K
N S H

Typ otworu



<math>< 1.5d</math>



<math>< 3d</math>



<math>< 2.5d</math>

Rodzaj materiału

HSSE

HSSE

HSSE

Rodzaj powłoki

TN2

TN2

TN2

Nakrój

C / 2-3P

B / 4-5P

C / 2-3P

G	$\varnothing d_1$	1"/P	P	l_1	l_2	l_2 R40	$\varnothing d_2$	a		Norma			DIN-5156				
										Tol.							
										INDEX	D2-123X01	D2-113X01	D2-513X01				
G1/16	7,723	28	0,907	90	17	10	6,0	4,9	6,80	3121	○	○	○				
G1/8	9,728	28	0,907	90	18	10	7,0	5,5	8,80	3123	●	●	●				
G1/4	13,157	19	1,337	100	22	14	11,0	9,0	11,80	3127	●	●	●				
G3/8	16,662	19	1,337	100	22	15	12,0	9,0	15,25	3129	●	●	●				
G1/2	20,955	14	1,814	125	25	17	16,0	12,0	19,00	3131	●	●	●				
G5/8	22,911	14	1,814	125	25	20	18,0	14,5	21,00	3133	●	●	●				
G3/4	26,441	14	1,814	140	28	20	20,0	16,0	24,50	3135	●	●	●				
G7/8	30,201	14	1,814	150	30	22	22,0	18,0	28,25	3137	●	●	●				
G1	33,249	11	2,309	160	32	24	25,0	20,0	30,75	3139	●	●	●				
G1.1/8	37,907	11	2,309	170	34	24	28,0	22,0	35,50	3141	○	○	○				
G1.1/4	41,910	11	2,309	170	34	25	32,0	24,0	39,50	3143	○	○	○				
G1.1/2	47,800	11	2,309	190	36	-	36,0	29,0	45,25	3147	○	○	-				
G1.3/4	53,756	11	2,309	190	36	-	40,0	32,0	51,00	3151	○	○	-				
G2	59,614	11	2,309	220	40	-	45,0	35,0	57,00	3155	○	○	-				
											ISO			Vc (m/min)			
											P	5-35	5-35	5-20			
											M	5-15	5-15	5-15			
											K	5-25	10-25	5-15			
											N	10-30	10-30	5-25			
											S	-	-	-			

800X



Gwint rurowy walcowy G, DIN-ISO 228											800					
											C	B	C-R40			
Rodzaj materiału obrabianego																
Typ otworu																
Rodzaj materiału											HSSE					
Rodzaj powłoki																
Nakrój											C / 2-3P					
											Norma			DIN-5156		
											Tol.					
											INDEX			D2-121101	D2-111101	D2-511101
G	Ød ₁	1"/P	P	l ₁	l ₂	l ₂ R40	Ød ₂	a								
G1/16	7,723	28	0,907	90	17	10	6,0	4,9	6,80	3121	○	○	○			
G1/8	9,728	28	0,907	90	18	10	7,0	5,5	8,80	3123	●	●	●			
G1/4	13,157	19	1,337	100	22	14	11,0	9,0	11,80	3127	●	●	●			
G3/8	16,662	19	1,337	100	22	15	12,0	9,0	15,25	3129	●	●	●			
G1/2	20,955	14	1,814	125	25	17	16,0	12,0	19,00	3131	●	●	●			
G5/8	22,911	14	1,814	125	25	20	18,0	14,5	21,00	3133	●	●	●			
G3/4	26,441	14	1,814	140	28	20	20,0	16,0	24,50	3135	●	●	●			
G7/8	30,201	14	1,814	150	30	22	22,0	18,0	28,25	3137	●	●	●			
G1	33,249	11	2,309	160	32	24	25,0	20,0	30,75	3139	●	●	●			
G1.1/8	37,907	11	2,309	170	34	24	28,0	22,0	35,50	3141	○	○	○			
G1.1/4	41,910	11	2,309	170	34	25	32,0	24,0	39,50	3143	○	○	○			
G1.1/2	47,800	11	2,309	190	36	-	36,0	29,0	45,25	3147	○	○	-			
G1.3/4	53,756	11	2,309	190	36	-	40,0	32,0	51,00	3151	○	○	-			
G2	59,614	11	2,309	220	40	-	45,0	35,0	57,00	3155	○	○	-			
											ISO			Vc (m/min)		
											P			5-20	5-20	5-20
											M			5-10	5-10	5-10
											K			5-15	5-15	5-15
											N			5-25	5-25	5-25
											S			-	-	-

1

Gwint rurowy walcowy G, DIN-ISO 228

Ms

F

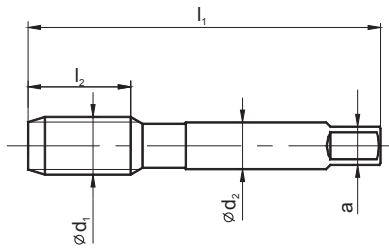

HSSE

DIN
~5157

Rodzaj materiału obrabianego



Typ otworu



Rodzaj materiału

HSSE

Rodzaj powłoki

Nakrój

F / 1P

G	$\varnothing d_1$	1"/P	P	l_1	l_2	$\varnothing d_2$	a		Norma					
									~DIN-5157	Tol.				
									INDEX	E2-141401				
G3/8	16,662	19	1,337	70	22	12	9	15,25	3129	●				
G1/2	20,965	14	1,814	80	22	16	12	19,00	3131	●				
G3/4	26,441	14	1,814	90	22	20	16	24,50	3135	●				
G1	33,259	11	2,309	100	25	25	20	30,75	3139	●				

ISO	Vc (m/min)				
P	-				
M	-				
K	-				
N	10-25				
S	-				

Gwint rurowy walcowy G, DIN-ISO 228

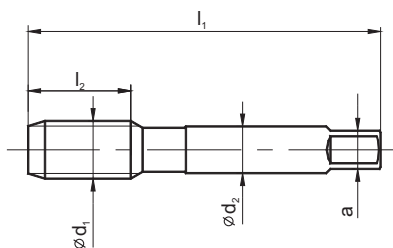
HSS
DIN 5157

Rodzaj materiału obrabianego



Typ otworu



Rodzaj materiału

HSS

Rodzaj powłoki

Nakrój

~3P

G	Ød ₁	1"/P	P	l ₁	l ₂	l ₃	Ød ₂	a		Norma					
										DIN-5157					
										Tol.					
										INDEX					
G1/16	7,723	28	0,907	56	22	-	6	4,9	6,80	3121	○				
G1/8	9,728	28	0,907	63	20	-	7	5,5	8,80	3123	○				
G1/4	13,157	19	1,337	70	22	-	11	9,0	11,80	3127	●				
G3/8	16,662	19	1,337	70	22	-	12	9,0	15,25	3129	●				
G1/2	20,955	14	1,814	80	22	-	16	12,0	19,00	3131	●				
G5/8	22,911	14	1,814	80	22	-	18	14,5	21,00	3133	○				
G3/4	26,441	14	1,814	90	22	-	20	16,0	24,50	3135	●				
G7/8	30,201	14	1,814	90	22	-	22	18,0	28,25	3137	○				
G1	33,249	11	2,309	100	25	-	25	20,0	30,75	3139	●				
G1.1/8	37,897	11	2,309	125	36	-	28	22,0	35,50	3141	○				
G1.1/4	41,910	11	2,309	125	36	-	32	24,0	39,50	3143	○				
G1.3/8	44,323	11	2,309	125	36	-	36	29,0	41,75	3145	○				
G1.1/2	47,803	11	2,309	140	40	-	36	29,0	45,25	3147	○				
G1.3/4	53,769	11	2,309	140	40	-	40	32,0	51,00	3151	○				
G2	59,614	11	2,309	160	40	-	45	35,0	57,00	3155	○				

ISO	Vc (m/min)			
P	5-20			
M	-			
K	-			
N	-			
S	-			

Przykład zamawiania

 E1-131001-3127
 Gwintownik G-1/4" DIN-5157 HSS

- Dostępne z magazynu
- Na zapytanie

1

Gwint rurowy walcowy G, DIN-ISO 228

NGRf



HSS

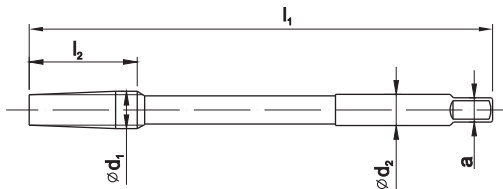

Rodzaj materiału obrabianego



Typ otworu



Rodzaj materiału

HSS

Rodzaj powłoki

Nakrój

12P

G	Ød ₁	1"/P	P	l ₁	l ₂	l ₃	Ød ₂	a		Norma	NGRf			
										Tol.				
										INDEX				
G1/16	7,723	28	0,907	140	20	-	6,0	4,5	6,80	3121	o			
G1/8	9,728	28	0,907	140	20	-	7,0	6,3	8,80	3123	o			
G1/4	13,157	19	1,337	180	30	-	11,0	8,0	11,80	3127	o			
G3/8	16,662	19	1,337	200	30	-	12,0	10,0	15,25	3129	o			
G1/2	20,955	14	1,814	220	40	-	16,0	12,5	19,00	3131	●			
G5/8	22,911	14	1,814	220	40	-	18,0	14,0	21,00	3133	o			
G3/4	26,441	14	1,814	250	40	-	20,0	16,0	24,00	3135	o			
G7/8	30,201	14	1,814	280	40	-	22,0	18,0	28,25	3137	o			
G1	33,249	11	2,309	280	60	-	25,0	20,0	30,75	3139	o			
G1.1/8	37,907	11	2,309	280	60	-	28,0	22,4	35,50	3141	-			
G1.1/4	41,910	11	2,309	280	60	-	32,0	25,0	39,50	3143	o			
G1.3/8	44,323	11	2,309	280	60	-	32,0	25,0	42,00	3145	-			
G1.1/2	47,800	11	2,309	280	60	-	36,0	28,0	45,00	3147	o			
G1.3/4	53,756	11	2,309	280	60	-	40,0	28,0	51,00	3151	-			
G2	59,614	11	2,309	280	60	-	45,0	31,5	57,00	3155	o			

ISO	Vc (m/min)			
P	5-20			
M	-			
K	6-15			
N	6-15			
S	-			



Gwint rurowy walcowy Rp, PN-ISO 7/1, DIN EN 10226-1											800				
											c	c			
Gwint rurowy stożkowy Rc, PN-ISO 7/1, DIN EN 10226-2 															
HSSE DIN 5156 DIN ~5156															
Rodzaj materiału obrabianego															
Typ otworu															
Rodzaj materiału											HSSE	HSSE			
Rodzaj powłoki															
Nakrój											C / 2-3P	C / 2-3P			
Rp	Ød ₁	1"/P	P	l ₁	l ₂	l ₃	Ød ₂	a		Norma	DIN-5156				
										Tol.					
										INDEX	D2-121101				
Rp-1/16"	7,723	28	0,907	90	17	-	6,0	4,9		3221	o				
Rp-1/8"	9,728	28	0,907	90	18	-	7,0	5,5		3223	o				
Rp-1/4"	13,157	19	1,337	100	22	-	11,0	9,0		3227	o				
Rp-3/8"	16,662	19	1,337	100	22	-	12,0	9,0		3229	o				
Rp-1/2"	20,955	14	1,814	125	25	-	16,0	12,0		3231	o				
Rp-3/4"	26,441	14	1,814	140	28	-	20,0	16,0		3235	o				
Rp-1"	33,249	11	2,309	160	32	-	25,0	20,0		3239	o				

Rc	Ød ₁	1"/P	P	l ₁	l ₂	l ₃	Ød ₂	a		Norma	~DIN-5156			
										Tol.				
										INDEX	D2-121101			
Rc-1/16"	-	28	0,907	90	15	-	6,0	4,9		3321	o			
Rc-1/8"	-	28	0,907	90	15	-	7,0	5,5		3323	•			
Rc-1/4"	-	19	1,337	100	19	-	11,0	9,0		3327	•			
Rc-3/8"	-	19	1,337	100	21	-	12,0	9,0		3329	•			
Rc-1/2"	-	14	1,814	125	26	-	16,0	12,0		3331	o			
Rc-3/4"	-	14	1,814	140	28	-	20,0	16,0		3335	o			
Rc-1"	-	11	2,309	160	33	-	25,0	20,0		3339	o			

ISO	V _c (m/min)				
P	5-20	5-20			
M	5-10	5-10			
K	5-15	5-15			
N	10-25	10-25			
S	-	-			



Pogłębiacze stożkowe 1:16 na str. 174



Informacje odnośnie wymiarów otworów pod gwinty stożkowe w części technicznej katalogu na str. 335

Przykład zamawiania

 D2-121101-3221
 Gwintownik Rp-1/16" DIN-5156 C HSSE

- Dostępne z magazynu
- Na zapytanie

1

**Gwint amerykański rurowy stożkowy
NPT 1:16, ANSI B-1.20.1**

800

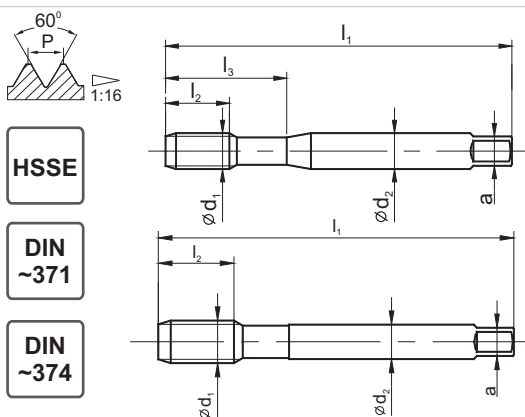

c



Rodzaj materiału obrabianego



Typ otworu



Rodzaj materiału

HSSE

Rodzaj powłoki

Nakrój

C / 2-3P

NPT	Ød ₁	1"/P	P	l ₁	l ₂	l ₃	Ød ₂	a		Norma					
										~DIN-371					
										Tol.					
										INDEX	C2-121101				
1/8	-	27	0,941	90	15	35	10,0	8,0	8,50	4623	●				
1/4	-	18	1,411	100	20	37,7	14,0	11,0	11,10	4627	●				

NPT	1"/P	P	l ₁	l ₂	l ₃	Ød ₂	a		Norma					
									~DIN-374					
									Tol.					
									INDEX	D2-121101				
3/8	18	1,411	110	22	-	14,0	11,0	14,40	4629	●				
1/2	14	1,814	140	27	-	18,0	14,5	17,80	4631	●				
3/4	14	1,814	140	28	-	20,0	16,0	23,15	4635	●				
1	11.1/2	2,209	160	35	-	25,0	20,0	29,05	4639	●				

ISO	V _c (m/min)			
P	5-20			
M	5-10			
K	5-15			
N	10-25			
S	-			



Gwint amerykański rurowy stożkowy NPTF 1:16, ANSI B-1.20.1										800					
Rodzaj materiału obrabianego															
Typ otworu															
Rodzaj materiału										HSSE					
Rodzaj powłoki															
Nakrój										C / 2-3P					
NPTF	Ød ₁	1"/P	P	l ₁	l ₂	Ød ₂	a		Norma	~DIN-374					
									Tol.						
								INDEX	D2-121101						
1/8	-	27	0,941	90	15	7,0	5,5	8,45	4723	●					
1/4	-	18	1,411	100	20	11,0	9,0	10,90	4727	○					
3/8	-	18	1,411	110	22	14,0	11,0	14,30	4729	○					
1/2	-	14	1,814	140	27	18,0	14,5	17,60	4731	○					
										ISO		Vc (m/min)			
										P	5-20				
										M	5-10				
										K	5-15				
										N	10-25				
										S	-				

1

**Gwint amerykański walcowy rurowy NPSF,
ANSI B 1.20.3**

800

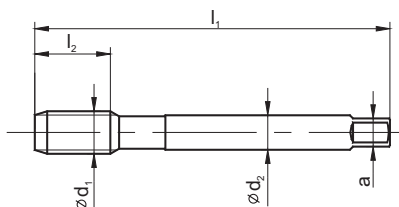

HSSE

DIN
~374

Rodzaj materiału obrabianego



Typ otworu



Rodzaj materiału

HSSE

Rodzaj powłoki

Nakrój

C / 2-3P

NPSF	Ød ₁	1"/P	P	l ₁	l ₂	Ød ₂	a		Norma					
									~DIN-374	Tol.	INDEX			
1/16	7,582	27	0,941	90	20	6,0	4,9	6,35	4521	o				
1/8	9,929	27	0,941	90	20	7,0	5,5	8,70	4523	o				
1/4	13,236	18	1,411	100	20	11,0	9,0	11,30	4527	o				
3/8	16,673	18	1,411	100	20	12,0	9,0	14,75	4529	o				
1/2	20,814	14	1,814	125	27	16,0	12,0	18,20	4531	o				
3/4	26,166	14	1,814	140	27	20,0	16,0	23,50	4535	o				
1	32,718	11.1/2	2,209	160	32	25,0	20,0	29,50	4539	o				

ISO	Vc (m/min)				
P	5-20				
M	5-10				
K	5-15				
N	5-25				
S	-				



Gwint calowy zwykły Whitwortha BSW, BS-84:1956												800					
												B	C-R40				
Rodzaj materiału obrabianego																	
Typ otworu																	
Rodzaj materiału												HSSE					
Rodzaj powłoki																	
Nakrój												B / 4-5P		C / 2-3P			
BSW	Ød ₁	1"/P	P	l ₁	l ₂	l ₂ R40	l ₃	Ød ₂	a		Norma						
											DIN-371(~DIN2182)						
											Tol.	normal	normal				
											INDEX	C2-111101	C2-511101				
1/8-40	3,175	40	0,635	56	10	5	18	3,5	2,7	2,55	7123	o	o				
3/16-24	4,762	24	1,058	70	14	8	25	6,0	4,9	3,70	7125	o	o				
1/4-20	6,350	20	1,270	80	18	13	32	7,0	5,5	5,10	7127	o	o				
5/16-18	7,938	18	1,411	90	20	13	35	8,0	6,2	6,50	7128	o	o				
3/8-16	9,525	16	1,588	100	20	15	39	10,0	8,0	7,90	7129	o	o				

BSW	Ød ₁	1"/P	P	l ₁	l ₂	l ₂ R40	l ₃	Ød ₂	a		Norm								
											DIN-376(~DIN2182)								
											Tol.								
											INDEX	D2-111101	D2-511101						
7/16-14	11,112	14	1,814	100	22	15	-	8,0	6,2	9,25	7130	o	o						
1/2-12	12,700	12	2,117	110	24	18	-	9,0	7,0	10,50	7131	o	o						
5/8-11	15,875	11	2,309	110	32	22	-	12,0	9,0	13,50	7133	o	o						
3/4-10	19,050	10	2,540	125	32	25	-	14,0	11,0	16,40	7135	o	o						
7/8-9	22,225	9	2,822	140	32	30	-	18,0	14,5	19,25	7137	o	o						
1-8	25,400	8	3,175	160	38	30	-	20,0	16,0	22,00	7139	o	o						
												ISO				Vc (m/min)			
												P	5-20	5-20					
												M	5-10	5-10					
												K	5-15	5-15					
												N	5-25	5-25					
												S	-	-					

1

MASTER TAP

Gwint metryczny zwykły ISO DIN 8140-2

MASTER TAP

B-HL E-R45-HL

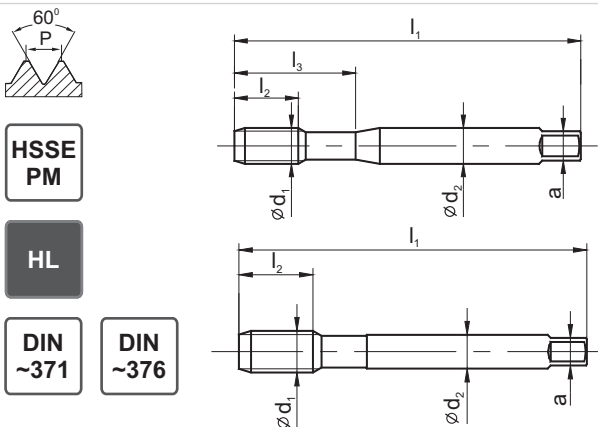

Rodzaj materiału obrabianego

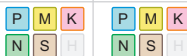

Typ otworu

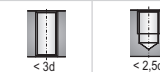

Rodzaj materiału

HSSE-PM HSSE-PM

Rodzaj powłoki

HL HL

Nakrój

B / 4-5P E / 1,5-2P

EG M (STI)	Ød ₁	P	l ₁	l ₂	l ₂ R45	l ₃	Ød ₂	a		Norma ~DIN-371(DIN-40435)		
										Tol.	6H mod.	6H mod.
										INDEX	C4-118M01	C4-718M01
M2	2,520	0,40	50	9	5	14	2,8	2,1	2,10	6020	●	●
M2,5	3,084	0,45	56	10	5	18	3,5	2,7	2,65	6025	●	●
M3	3,650	0,50	63	12	5	21	4,5	3,4	3,15	6030	●	●
M4	4,910	0,70	70	14	8	25	6,0	4,9	4,20	6040	●	●
M5	6,040	0,80	80	18	10	30	6,0	4,9	5,25	6050	●	●
M6	7,300	1,00	90	18	10	35	8,0	6,2	6,30	6060	●	●
M8	9,624	1,25	100	20	13	39	10,0	8,0	8,40	6080	●	●

EG M (STI)	Ød ₁	P	l ₁	l ₂	l ₂ R45	l ₃	Ød ₂	a		Norma ~DIN-376(DIN-40435)		
										Tol.	6H mod.	6H mod.
										INDEX	D4-118M01	D4-718M01
M10	11,948	1,50	100	15	15	-	9,0	7,0	10,50	6100	●	●
M12	14,274	1,75	110	20	20	-	11,0	9,0	12,50	6120	●	●
M14	16,598	2,00	110	20	20	-	12,0	9,0	14,50	6140	●	●
M16	18,598	2,00	125	20	20	-	14,0	11,0	16,50	6160	●	●
M18	21,248	2,50	140	27	27	-	18,0	14,5	18,75	6180	●	●
M20	23,248	2,50	160	30	30	-	18,0	14,5	20,75	6200	●	●

ISO	Vc (m/min)		
P	5-40	5-40	
M	5-15	5-15	
K	10-30	10-30	
N	10-30	10-30	
S	1-8	1-8	



Gwint amerykański zunifikowany UNC, ASME B18.29.1											MASTER TAP								
											B-HL		E-R45-HL						
Rodzaj materiału obrabianego																			
Typ otworu																			
Rodzaj materiału											HSSE-PM		HSSE-PM						
Rodzaj powłoki											HL		HL						
Nakrój											B / 4-5P		E / 1,5-2P						
EG UNC (STI)	Ød ₁	1/P	l ₁	l ₂	l ₂ R45	l ₃	Ød ₂	a		Norma	~DIN-371(DIN-40435)								
										Tol.	2B	2B							
										INDEX	C4-118M01	C4-718M01							
No4-40	3,671	40	63	13	7	21	4,5	3,4	3,10	6804	o	o							
No6-32	4,536	32	70	14	8	25	6,0	4,9	3,80	6806	o	o							
No8-32	5,197	32	80	16	10	30	6,0	4,9	4,40	6808	o	o							
No10-24	6,200	24	80	17	12	30	7,0	5,5	5,20	6810	o	o							
1/4-20	8,002	20	90	20	15	35	8,0	6,2	6,70	6827	o	o							
5/16-18	9,771	18	100	22	18	39	10,0	8,0	8,40	6828	o	o							
EG UNC (STI)	Ød ₁	1/P	l ₁	l ₂	l ₂ R45	l ₃	Ød ₂	a		Norm	~DIN-376(DIN-40435)								
										Tol.	2B	2B							
										INDEX	D4-118M01	D4-718M01							
3/8-16	11,587	16	100	15	15	-	9	7	10	6829	o	o							
7/16-14	13,469	14	110	18	18	-	11	9	11,6	6830	o	o							
1/2-13	15,237	13	110	18	18	-	12	9	13,3	6831	o	o							
9/16-12	17,039	12	110	20	20	-	12	9	14,9	6832	o	o							
5/8-11	18,875	11	125	20	20	-	14	11	16,5	6833	o	o							
3/4-10	22,349	10	140	25	25	-	18	14,5	19,75	6835	o	o							
											ISO		Vc (m/min)						
											P	5-40	5-40						
											M	5-15	5-15						
											K	10-30	10-30						
											N	10-30	10-30						
											S	1-8	1-8						

MASTER TAP

1

MASTER TAP

Gwint amerykański zunifikowany drobnozwojny UNF, ASME B18.29.1

MASTERTAP

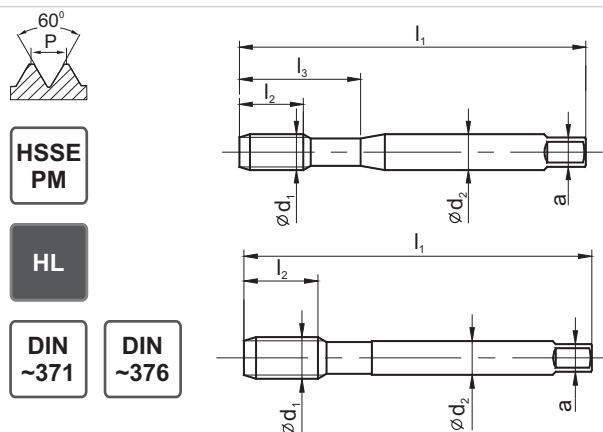

B-HL E-R45-HL



Rodzaj materiału obrabianego

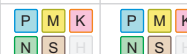

Typ otworu



Rodzaj materiału

HSSE-PM HSSE-PM

Rodzaj powłoki

HL HL

Nakrój

B / 4-5P E / 1,5-2P

EG UNF (STI)	Ød ₁	1/P	l ₁	l ₂	l ₂ R45	l ₃	Ød ₂	a		Norma ~DIN-371(DIN-40435)						
										Norma	2B	2B				
										Tol.	2B	2B				
											INDEX	C4-118M01	C4-718M01			
No4-48	3,533	48	56	9	6	20	4	3	3	6904	o	o				
No6-40	4,330	40	70	10	7	25	6	4,9	3,7	6906	o	o				
No8-36	5,083	36	80	13	9	30	6	4,9	4,4	6908	o	o				
No10-32	5,858	32	80	13	9	30	6	4,9	5,1	6910	o	o				
1/4-28	7,528	28	90	17	10	35	8	6,2	6,6	6927	o	o				
5/16-24	9,312	24	90	18	12	35	10	8	8,3	6928	o	o				

EG UNF (STI)	Ød ₁	1/P	l ₁	l ₂	l ₂ R45	l ₃	Ød ₂	a		Norm ~DIN-376(DIN-40435)						
										Norm	2B	2B				
										Tol.	2B	2B				
											INDEX	D4-118M01	D4-718M01			
3/8-24	10,899	24	90	12	12	-	8	6	9,8	6929	o	o				
7/16-20	12,763	20	100	15	15	-	9	7	11,5	6930	o	o				
1/2-20	14,352	20	100	15	15	-	11	9	13,1	6931	o	o				
9/16-18	16,121	18	100	15	15	-	12	9	14,7	6932	o	o				
5/8-18	17,709	18	110	15	15	-	14	11	16,25	6933	o	o				
3/4-16	21,112	16	125	17	17	-	16	12,0	19,5	6935	o	o				

ISO	Vc (m/min)				
P	5-40	5-40			
M	5-15	5-15			
K	10-30	10-30			
N	10-30	10-30			
S	1-8	1-8			



Gwint trapezowy Tr, DIN-103								NGSt					
 								LH					
Rodzaj materiału obrabianego													
Typ otworu													
Rodzaj materiału								HSS	HSS				
Rodzaj powłoki								-	-				
Nakrój								24P	24P				
Tr Ød ₁	P	l ₁	l ₂	Ød ₂	a		Norma	NGSt					
							Tol.	7H	7H				
							INDEX	G1-701002	G1-751002				
Tr 10x1,5	1,5	100	45	7	5,5	8,5	8008	○	○				
Tr 10x2	2	115	76	7	5,5	8	8009	●	○				
Tr 12x2	2	120	74	8	6,3	10	8014	●	○				
Tr 12x3	3	155	104	8	6,3	9	8015	●	○				
Tr 14x2	2	130	74	10	8	12	8018	●	○				
Tr 14x3	3	160	104	10	8	11	8019	●	○				
Tr 16x2	2	135	74	11,2	9	14	8022	●	○				
Tr 16x4	4	200	132	11,2	9	12	8024	●	○				
Tr 18x2	2	140	74	12,5	10	16	8030	○	○				
Tr 18x4	4	205	132	12,5	10	14	8032	○	○				
Tr 20x2	2	145	74	14	11,2	18	8033	○	○				
Tr 20x4	4	210	132	14	11,2	16	8034	○	○				
Tr 22x3	3	185	104	16	12,5	19	8035	○	○				
Tr 22x5	5	250	165	16	12,5	17	8037	○	○				
Tr 24x3	3	190	104	18	14	21	8040	○	○				
Tr 24x5	5	255	165	18	14	19	8042	○	○				
Tr 26x3	3	195	104	20	16	23	8045	○	○				
Tr 26x5	5	265	165	20	16	21	8047	○	○				
Tr 28x3	3	205	104	22,4	18	25	8050	○	○				
Tr 28x5	5	270	165	22,4	18	23	8052	○	○				
Tr 30x3	3	205	104	22,4	18	27	8055	○	○				
Tr 30x6	6	305	206	22,4	18	24	8057	○	○				
Tr 32x6	6	315	206	25	20	26	8062	○	○				
Tr 36x6	6	325	206	28	22,4	30	8072	○	○				
ISO								Vc (m/min)					
P								2-6	2-6				
M								-	-				
K								2-6	2-6				
N								2-8	2-8				
S								-	-				

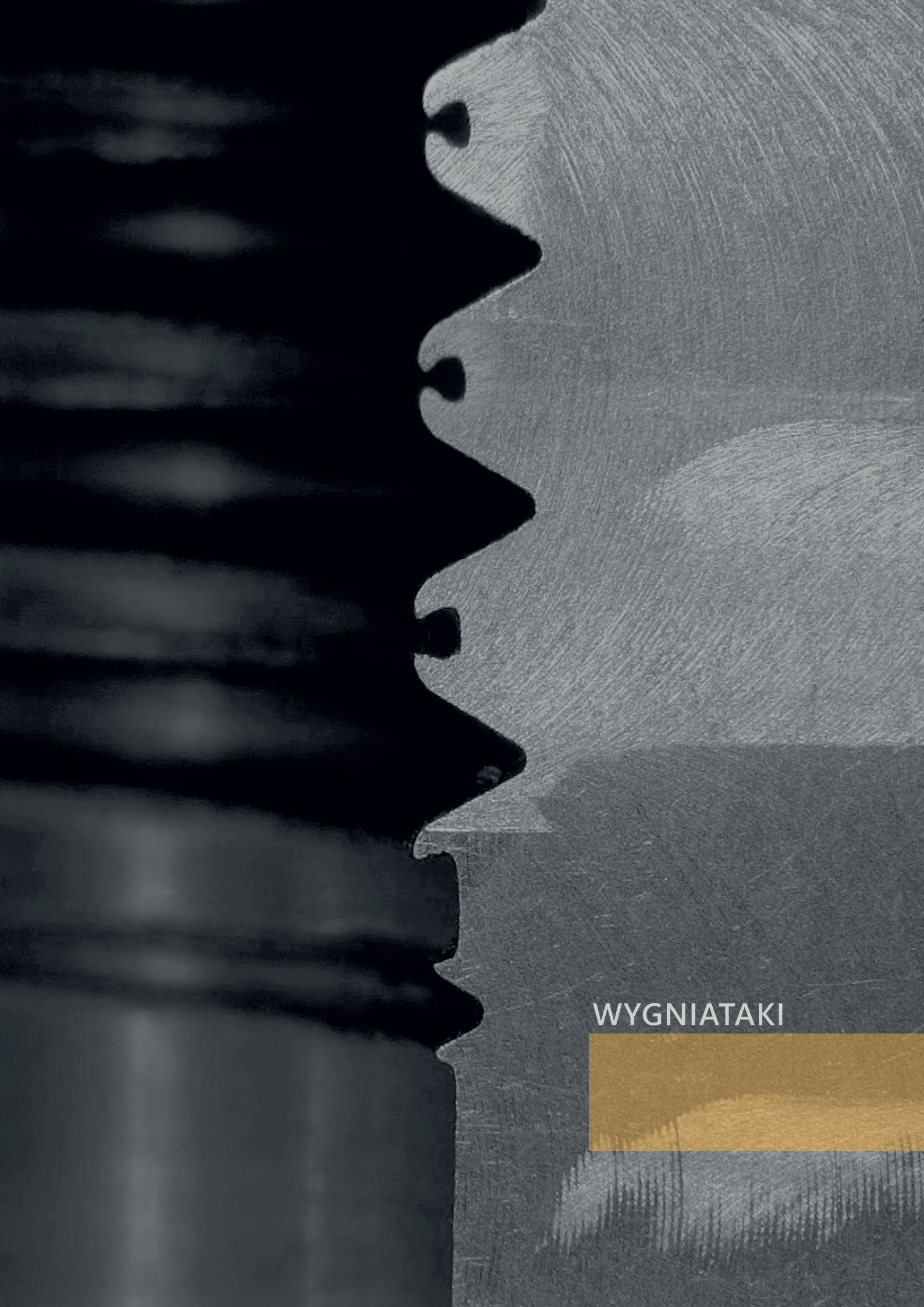

WYGNIATAKI



TABELA DOBORU

4

STRONY KATALOGOWE

93 - 97

M	DIN-371 DIN-376	Wygniaki z chwytem wzmacnionym Wygniaki z chwytem przelotowym	WGN	93
MF	DIN-371 DIN-374	Wygniaki z chwytem wzmacnionym Wygniaki z chwytem przelotowym	WGN	94
UNC	DIN-371 DIN-376	Wygniaki z chwytem wzmacnionym Wygniaki z chwytem przelotowym	WGN	95
UNF	DIN-371 DIN-374	Wygniaki z chwytem wzmacnionym Wygniaki z chwytem przelotowym	WGN	96
G	~DIN-5156	Wygniaki z chwytem przelotowym	WGN	97



Gwint metryczny ISO DIN-13									WGN							
									C-TN2	C-SR-TN2	C-SR-TN2	C-SR-TC	E-SR-TC	E-SR-IK-TC	E-SR-IKR-TC	
Rodzaj materiału obrabianego																
Typ otworu																
Rodzaj materiału									HSSE-PM HSSE-PM HSSE-PM HSSE-PM HSSE-PM HSSE-PM HSSE-PM							
Rodzaj powłoki									TN2 TN2 TN2 TC TC TC TC							
Nakrój									C / 2-3P C / 2-3P C / 2-3P C / 2-3P E / 1,5-2P E / 1,5-2P E / 1,5-2P							
M $\varnothing d_1$	P	l_1	l_2	l_3	$\varnothing d_2$	a		Norma	DIN-371 (~DIN-2174)							
									Tol.	6HX	6HX	6GX	6HX	6HX	6HX	6HX
								INDEX	C4-903005	C4-923005	C4-923006	C4-925005	C4-945005	C4-945055	C4-945065	
M 1,6	0,35	40	8	8	2,5	2,1	1,47	0016	●	●	-	-	-	-	-	
M 2	0,40	45	8	8	2,8	2,1	1,85	0020	●	●	-	-	-	-	-	
M 2,5	0,45	50	9	9	2,8	2,1	2,33	0025	●	●	-	-	-	-	-	
M 3	0,50	56	10	18	3,5	2,7	2,80	0030	●	●	●	●	●	-	-	
M 3,5	0,60	56	12	20	4	3	3,25	0035	○	○	○	○	○	-	-	
M 4	0,70	63	7	21	4,5	3,4	3,70	0040	●	●	●	●	●	-	-	
M 5	0,80	70	8	25	6	4,9	4,65	0050	●	●	●	●	●	●	●	
M 6	1,00	80	10	30	6	4,9	5,60	0060	●	●	●	●	●	●	●	
M 7	1,00	80	10	30	7	5,5	6,60	0070	○	○	○	○	○	○	○	
M 8	1,25	90	13	35	8	6,2	7,45	0080	●	●	●	●	●	●	●	
M 9	1,25	90	13	35	9	7	8,45	0090	○	○	○	○	○	○	○	
M 10	1,50	100	15	39	10	8	9,35	0100	●	●	●	●	●	●	●	
M $\varnothing d_1$	P	l_1	l_2	l_3	$\varnothing d_2$	a		Norma	DIN-376 (~DIN-2174)							
									Tol.	6HX	6HX	6GX				
								INDEX	D4-903005	D4-923005	D4-923006					
M6	1	80	10	-	4,5	3,4	5,60	0060	●	●	●					
M8	1,25	90	13	-	6	4,9	7,45	0080	●	●	●					
M 10	1,5	100	15	-	7	5,5	9,35	0100	●	●	●					
M 12	1,75	110	18	-	9	7	11,25	0120	●	●	●					
M 14	2	110	20	-	11	9	13,10	0140	●	●	●					
M 16	2	110	20	-	12	9	15,10	0160	●	●	●					
M 18	2,5	125	25	-	14	11	16,85	0180	●	●	●					
M 20	2,5	140	25	-	16	12	18,85	0200	●	●	●					
									Vc (m/min)							
									ISO							
									P	10-30	10-30	10-30	10-30	10-30	10-50	10-50
									M	10-25	10-25	10-25	10-25	10-25	10-25	10-25
									K	-	-	-	-	-	-	-
									N	20-40	20-40	20-40	20-60	20-60	20-60	20-60
									S	-	-	-	-	-	-	-

2

Gwint metryczny drobnozwojny ISO DIN-13									WGN					
									C-SR-TN2	C-SR-TC				
<div style="display: flex; flex-direction: column; align-items: flex-start;"> <div style="border: 1px solid black; padding: 2px; margin-bottom: 2px;">HSSE PM</div> <div style="border: 1px solid black; padding: 2px; margin-bottom: 2px;">TN2</div> <div style="border: 1px solid black; padding: 2px; margin-bottom: 2px;">TC</div> <div style="border: 1px solid black; padding: 2px; margin-bottom: 2px;">DIN 371</div> <div style="border: 1px solid black; padding: 2px; margin-bottom: 2px;">DIN 374</div> </div>									<div style="display: flex; justify-content: space-around;"> <div style="display: flex; flex-direction: column; gap: 2px;"> <div style="border: 1px solid black; padding: 1px;">P</div> <div style="border: 1px solid black; padding: 1px;">M</div> <div style="border: 1px solid black; padding: 1px;">K</div> <div style="border: 1px solid black; padding: 1px;">N</div> <div style="border: 1px solid black; padding: 1px;">S</div> <div style="border: 1px solid black; padding: 1px;">H</div> </div> <div style="display: flex; flex-direction: column; gap: 2px;"> <div style="border: 1px solid black; padding: 1px;">P</div> <div style="border: 1px solid black; padding: 1px;">M</div> <div style="border: 1px solid black; padding: 1px;">K</div> <div style="border: 1px solid black; padding: 1px;">N</div> <div style="border: 1px solid black; padding: 1px;">S</div> <div style="border: 1px solid black; padding: 1px;">H</div> </div> </div>					
Rodzaj materiału obrabianego														
Typ otworu														
Rodzaj materiału									HSSE-PM					
Rodzaj powłoki									TN2					
Nakrój									C / 2-3P					
MF $\varnothing d_1$	P	l_1	l_2	l_3	$\varnothing d_2$	a		Norma	DIN-371 (~DIN-2174)					
								Tol.	6HX	6HX				
								INDEX	C4-923005	C4-925005				
M 4 x 0,5	0,5	63	7	21	4,5	3,4	3,80	0041	●	●				
M 5 x 0,5	0,5	70	8	25	6	4,9	4,80	0051	●	●				
M 6 x 0,5	0,5	80	10	30	6	4,9	5,80	0061	●	●				
M 6 x 0,75	0,75	80	10	30	7	5,5	5,70	0062	●	●				
M 8 x 1	1	90	13	35	8	6,2	7,60	0083	●	●				
M 10 x 1	1	90	13	35	10	8	9,60	0103	●	●				
M 10 x 1,25	1,25	100	15	39	10	8	9,45	0104	●	●				
MF $\varnothing d_1$	P	l_1	l_2	l_3	$\varnothing d_2$	a		Norma	DIN-374 (~DIN-2174)					
								Tol.	6HX	6HX				
								INDEX	D4-923005	D4-925005				
M 6 x 0,5	0,5	80	10	-	4,5	3,4	5,80	0061	○	○				
M 6 x 0,75	0,75	80	10	-	4,5	3,4	5,70	0062	○	○				
M 8 x 1	1	90	10	-	6,0	4,9	7,60	0083	●	●				
M 10 x 1	1	90	10	-	7,0	5,5	9,60	0103	●	●				
M 10 x 1,25	1,25	100	15	-	7,0	5,5	9,45	0104	●	●				
M 12 x 1	1	100	10	-	9,0	7	11,60	0123	●	●				
M 12 x 1,25	1,25	100	15	-	9,0	7	11,45	0124	●	●				
M 12 x 1,5	1,5	100	15	-	9,0	7	11,35	0125	●	●				
M 16 x 1,5	1,5	100	15	-	12	9	15,35	0165	●	●				
M 18 x 1,5	1,5	110	17	-	14	11	17,35	0185	●	●				
M 20 x 1,5	1,5	125	17	-	16	12	19,35	0205	●	●				
ISO									Vc (m/min)					
P									10-30	10-30				
M									10-25	10-25				
K									-	-				
N									20-40	20-60				
S									-	-				



Gwint amerykański zunifikowany UNC, ANSI B-1.1											WGN											
											C-SR-TN2											
<div style="display: flex; flex-direction: column; align-items: center;"> <div style="border: 1px solid black; padding: 2px; margin-bottom: 5px;">HSSE</div> <div style="border: 1px solid black; padding: 2px; margin-bottom: 5px;">TN2</div> <div style="border: 1px solid black; padding: 2px; margin-bottom: 5px;">DIN 371</div> <div style="border: 1px solid black; padding: 2px;">DIN 376</div> </div>											<div style="display: flex; gap: 5px;"> P M K </div> <div style="display: flex; gap: 5px; margin-top: 5px;"> N S H </div>											
Rodzaj materiału obrabianego																						
Typ otworu																						
Rodzaj materiału											HSSE											
Rodzaj powłoki											TN2											
Nakrój											C / 2-3P											
											Norma		DIN-371 (~DIN-2174)									
											Tol.		2BX									
											INDEX		C2-923105									
UNC	Ød ₁	1"/P	P	l ₁	l ₂	l ₃	Ød ₂	a														
No 5-40	3,175	40	0,635	56	7	18	3,5	2,7	2,90	4105	o											
No 6-32	3,505	32	0,795	56	6	20	4,0	3,0	3,15	4106	o											
No 8-32	4,166	32	0,794	63	7	21	4,5	3,4	3,80	4108	o											
No 10-24	4,826	24	1,058	70	8	25	6,0	4,9	4,35	4110	o											
No 12-24	5,486	24	1,058	80	10	30	6,0	4,9	5,00	4112	o											
1/4-20	6,350	20	1,270	80	13	30	7,0	5,5	5,75	4127	o											
5/16-18	7,938	18	1,411	90	13	35	8,0	6,2	7,30	4128	o											
3/8-16	9,525	16	1,588	100	15	39	10	8	8,80	4129	o											
											Norma		DIN-376 (~DIN-2174)									
											Tol.		2BX									
											INDEX		D2-923105									
7/16-14	11,112	14	1,814	100	15	-	8	6,2	10,25	4130	o											
1/2-13	12,700	13	1,954	110	18	-	9	7	11,80	4131	o											
5/8-11	15,875	11	2,309	110	20	-	12	9	14,80	4133	o											
											ISO		Vc (m/min)									
											P		10-30									
											M		10-25									
											K		-									
											N		20-40									
											S		-									

2

**Gwint amerykański zunifikowany
drobnozwojny UNF, ANSI B-1.1**

WGN

C-SR-TN2

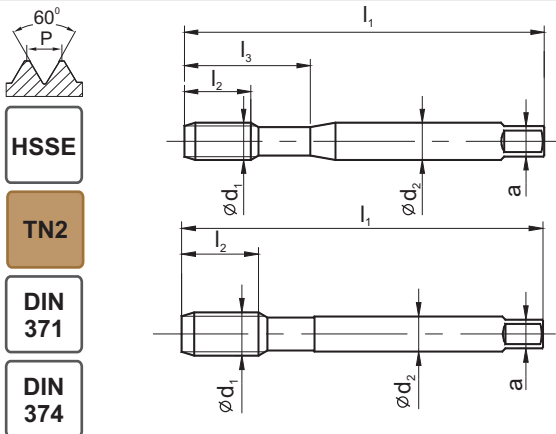

Rodzaj materiału obrabianego



Typ otworu



Rodzaj materiału

HSSE

Rodzaj powłoki

TN2

Nakrój

C / 2-3P

UNF	Ød ₁	1"/P	P	l ₁	l ₂	l ₃	Ød ₂	a		Norma						
										DIN-371 (~DIN-2174)						
										Tol.	2BX					
											INDEX	C2-923105				
No 5-44	3,175	44	0,577	56	7	18	3,5	2,7	2,92	4205	o					
No 6-40	3,505	40	0,635	56	6	20	4	3	3,22	4206	o					
No 8-36	4,166	36	0,706	63	7	21	4,5	3,4	3,85	4208	o					
No 10-32	4,826	32	0,794	70	8	25	6	4,9	4,45	4210	o					
No 12-28	5,486	28	0,907	80	10	30	6	4,9	5,10	4212	o					
1/4-28	6,350	28	0,907	80	10	30	6	4,9	5,95	4227	o					
5/16-24	7,938	24	1,058	90	13	35	8	6,2	7,45	4228	o					
3/8-24	9,525	24	1,058	90	15	35	10	8	9,05	4229	o					

UNF	Ød ₁	1"/P	P	l ₁	l ₂	Ød ₂	a		Norma							
									DIN-374 (~DIN-2174)							
									Tol.	2BX						
											INDEX	D2-923105				
7/16-20	11,112	20	1,270	100	15	8	6,2	10,55	4230	o						
1/2-20	12,700	20	1,270	110	15	9	7	12,15	4231	o						
5/8-18	15,875	18	1,411	110	15	12	9	15,25	4233	o						
3/4-16	19,050	16	1,588	120	17	14	11	18,35	4235	o						

ISO	Vc (m/min)			
P	10-30			
M	10-25			
K	-			
N	20-40			
S	-			

Gwint rurowy walcowy G, DIN-ISO 228										WGN										
										C-SR-TN2										
Rodzaj materiału obrabianego																				
Typ otworu																				
Rodzaj materiału										HSSE										
Rodzaj powłoki										TN2										
Nakrój										C / 2-3P										
										Norma ~DIN-5156										
										Tol.										
										INDEX D2-923105										
G	Ød ₁	1"/P	P	l ₁	l ₂	Ød ₂	a													
G-1/8"	9,728	28	0,907	90	10	7	5,5	9,25	3123	●										
G-1/4"	13,157	19	1,337	100	14	11	9	12,55	3127	●										
G-3/8"	16,662	19	1,337	100	15	12	9	16,05	3129	●										
G-1/2"	20,955	14	1,814	125	17	16	12	20,10	3131	●										
G-5/8"	22,911	14	1,814	125	20	18	14,5	22,05	3133	●										
G-3/4"	26,441	14	1,814	140	22	20	16	25,60	3135	●										
										ISO		V _c (m/min)								
										P		10-30								
										M		10-25								
										K		-								
										N		20-40								
										S		-								



FREZY DO GWINTÓW



TABELA DOBORU

4

STRONY KATALOGOWE

101 - 104

M MF	Frezy do gwintów		101
	Frezy do gwintów z częścią fazującą		102
	Frezy z krótką częścią skrawającą do materiałów zahartowanych	HRC	103
	Frezy do małych gwintów		104



Gwint metryczny ISO DIN-13								IK	
Rodzaj materiału obrabianego									
Rodzaj materiału								VHM	
Rodzaj powłoki								TS	
P	M	MF	Ød ₁	Ød ₂	l ₁	l ₂	z	INDEX	INDEX
0,5	M3	Ø ≥ 4	2,3	6	58,0	5,3	4	MI-41G100M-0050	-
0,5		Ø ≥ 5	3,9	6	58,0	10,3	4	MI-41G100M-0050A	MI-41G150M-0050A
0,7	M4	Ø ≥ 5	3,1	6	58,0	7,1	4	MI-41G100M-0070	MI-41G150M-0070
0,75		Ø ≥ 6	4,6	6	58,0	10,1	4	MI-41G100M-0075	MI-41G150M-0075
0,8	M5	Ø ≥ 6	3,9	6	58,0	8,7	4	MI-41G100M-0080	MI-41G150M-0080
1	M6	Ø ≥ 7	4,6	6	58,0	10,5	4	MI-41G100M-0100	MI-41G150M-0100
1	M6	Ø ≥ 7	4,6	6	58,0	15,0	4	MI-41G100M-0100A	MI-41G150M-0100A
1		Ø ≥ 9	6,0	6	58,0	12,5	4	MI-41G100M-0100B	MI-41G150M-0100B
1		Ø ≥ 10	8,0	8	64,0	16,5	4	MI-41G100M-0100C	MI-41G150M-0100C
1,25	M8	Ø ≥ 10	5,9	6	58,0	13,9	4	MI-41G100M-0125	MI-41G150M-0125
1,25	M8	Ø ≥ 10	5,9	6	58,0	20,0	4	MI-41G100M-0125A	MI-41G150M-0125A
1,5	M10	Ø ≥ 12	7,9	8	64,0	17,3	4	MI-41G100M-0150	MI-41G150M-0150
1,5	M10	Ø ≥ 12	7,9	8	76,0	25,0	4	MI-41G100M-0150A	MI-41G150M-0150A
1,5		Ø ≥ 14	10,0	10	73,0	21,8	4	MI-41G100M-0150B	MI-41G150M-0150B
1,5		Ø ≥ 20	15,9	16	105,0	33,8	4	MI-41G100M-0150C	MI-41G150M-0150C
1,75	M12	Ø ≥ 14	9,6	10	76,0	20,6	6	MI-61G100M-0175	MI-61G150M-0175
1,75	M12	Ø ≥ 14	9,6	10	76,0	30,0	6	MI-61G100M-0175A	MI-61G150M-0175A
2	M14/M16	Ø ≥ 17	11,4	12	73,0	27,0	6	MI-61G100M-0200	MI-61G150M-0200
2	M14/M16	Ø ≥ 17	11,4	12	105,0	39,0	6	MI-61G100M-0200A	MI-61G150M-0200A
2		Ø ≥ 20	15,9	16	105,0	35,0	6	MI-61G100M-0200B	MI-61G150M-0200B
2,5	M18/M20	Ø ≥ 22	14,9	16	84,0	33,8	6	MI-61G100M-0250	MI-61G150M-0250
2,5	M18/M20	Ø ≥ 22	14,9	16	105,0	50,0	6	MI-61G100M-0250A	MI-61G150M-0250A

ISO		Vc [m/min]	Posuw na ostrze [mm/ostrze]									
			Ø2	Ø3	Ø4	Ø6	Ø8	Ø10	Ø12	Ø14	Ø16	
P	P1-P5	Stal konstrukcyjna, stal do nawęglania	100-150	0,02	0,03	0,03	0,05	0,06	0,07	0,08	0,09	0,10
	P6-P9	Stal węglowa i niskostopowa, staliwo	85-120	0,015	0,02	0,025	0,03	0,04	0,05	0,06	0,07	0,08
	P10-P12	Stal stopowa, stal narzędziowa, stal do ulepszania cieplnie do 38 HRC	70-100	0,015	0,02	0,025	0,03	0,035	0,04	0,05	0,055	0,06
	P13-P14	Stal ferrytyczna i martenzytyczna	60-90	0,01	0,015	0,02	0,025	0,03	0,035	0,04	0,045	0,05
M	M1-M2	Stal austenityczna	60-90	0,01	0,015	0,02	0,025	0,03	0,035	0,04	0,045	0,05
	M3	Stal Duplex	50-70	0,01	0,015	0,02	0,025	0,03	0,035	0,04	0,045	0,05
K	K1-K5	Żeliwo szare	70-150	0,015	0,02	0,025	0,03	0,04	0,05	0,06	0,07	0,08
N	N1-N10	Aluminium i jego stopy 1% < Si < 7%, miedź niestopowa i stopowa	150-220	0,03	0,04	0,04	0,06	0,07	0,08	0,09	0,11	0,12
		Stopy aluminium Si ≥ 7%	100-180	0,02	0,02	0,03	0,03	0,04	0,05	0,05	0,06	0,07
		Duroplasty i Termoplasty	100-300	0,05	0,06	0,07	0,08	0,10	0,11	0,12	0,14	0,15

3

Gwint metryczny ISO DIN-13									
Rodzaj materiału obrabianego									
Rodzaj materiału								VHM	
Rodzaj powłoki								TS	
P	M	MF	Ød ₁	Ød ₂	l ₁	l ₂	z	INDEX	INDEX
0,5	M3	Ø ≥ 4	2,3	6	58,0	5,3	4	MI-41G1J0M-0050	-
0,7	M4	Ø ≥ 5	3,1	6	58,0	7,1	4	MI-41G1J0M-0070	MI-41G1K0M-0070
0,75		Ø ≥ 6	4,6	6	58,0	10,1	4	MI-41G1J0M-0075	MI-41G1K0M-0075
0,8	M5	Ø ≥ 6	3,9	6	58,0	8,7	4	MI-41G1J0M-0080	MI-41G1K0M-0080
1	M6	Ø ≥ 7	4,6	8	58,0	10,5	4	MI-41G1J0M-0100	MI-41G1K0M-0100
1	M6	Ø ≥ 7	4,6	8	58,0	15,0	4	MI-41G1J0M-0100A	MI-41G1K0M-0100A
1,25	M8	Ø ≥ 10	5,9	10	58,0	13,9	4	MI-41G1J0M-0125	MI-41G1K0M-0125
1,25	M8	Ø ≥ 10	5,9	10	58,0	20,0	4	MI-41G1J0M-0125A	MI-41G1K0M-0125A
1,5	M10	Ø ≥ 12	7,9	12	64,0	17,3	4	MI-41G1J0M-0150	MI-41G1K0M-0150
1,5	M10	Ø ≥ 12	7,9	12	76,0	25,0	4	MI-41G1J0M-0150A	MI-41G1K0M-0150A
1,75	M12	Ø ≥ 14	9,6	14	76,0	20,6	6	MI-61G1J0M-0175	MI-61G1K0M-0175
1,75	M12	Ø ≥ 14	9,6	14	76,0	30,0	6	MI-61G1J0M-0175A	MI-61G1K0M-0175A
2	M14		11,4	16	73,0	27,0	6	MI-61G1J0M-0200	MI-61G1K0M-0200
2	M16	Ø ≥ 17	13,4	18	105,0	39,0	6	MI-61G1J0M-0200A	MI-61G1K0M-0200A

ISO		Vc [m/min]	Posuw na ostrze [mm/ostrze]									
			Ø2	Ø3	Ø4	Ø6	Ø8	Ø10	Ø12	Ø14	Ø16	
P	P1-P5	Stal konstrukcyjna, stal do nawęglania	100-150	0,02	0,03	0,03	0,05	0,06	0,07	0,08	0,09	0,10
	P6-P9	Stal węglowa i niskostopowa, staliwo	85-120	0,015	0,02	0,025	0,03	0,04	0,05	0,06	0,07	0,08
	P10-P12	Stal stopowa, stal narzędziowa, stal do ulepszania ciepłnie do 38 HRC	70-100	0,015	0,02	0,025	0,03	0,035	0,04	0,05	0,055	0,06
	P13-P14	Stal ferrytyczna i martenzytyczna	60-90	0,01	0,015	0,02	0,025	0,03	0,035	0,04	0,045	0,05
M	M1-M2	Stal austenityczna	60-90	0,01	0,015	0,02	0,025	0,03	0,035	0,04	0,045	0,05
	M3	Stal Duplex	50-70	0,01	0,015	0,02	0,025	0,03	0,035	0,04	0,045	0,05
K	K1-K5	Żeliwo szare	70-150	0,015	0,02	0,025	0,03	0,04	0,05	0,06	0,07	0,08
N	N1-N10	Aluminium i jego stopy 1% < Si < 7%, miedź niestopowa i stopowa	150-220	0,03	0,04	0,04	0,06	0,07	0,08	0,09	0,11	0,12
		Stopy aluminium Si ≥ 7%	100-180	0,02	0,02	0,03	0,03	0,04	0,05	0,05	0,06	0,07
		Duroplasty i Termoplasty	100-300	0,05	0,06	0,07	0,08	0,10	0,11	0,12	0,14	0,15

Gwint metryczny ISO DIN-13							HRC			
VHM TS M04							M04 - lewe obroty			
Rodzaj materiału obrabianego										
Rodzaj materiału							VHM			
Rodzaj powłoki							TS			
P	M	Ød ₁	Ød ₂	l ₁	l ₂	z	INDEX			
0,5	M3	2,3	6	58	6,5	4	MI-40G9A2M-0050			
		2,3	6	58	9,5	4	MI-40G9A2M-0050A			
0,7	M4	3,1	6	58	9,0	4	MI-40G9A2M-0070			
		3,1	6	58	12,5	4	MI-40G9A2M-0070A			
0,8	M5	3,9	6	58	12,5	4	MI-40G9A2M-0080			
		3,9	6	58	16,0	4	MI-40G9A2M-0080A			
1	M6	4,6	6	58	14,0	4	MI-40G9A2M-0100			
		4,6	6	58	20,0	4	MI-40G9A2M-0100A			
1,25	M8	5,9	6	58	18,0	4	MI-40G9A2M-0125			
		5,9	6	58	24,0	4	MI-40G9A2M-0125A			
1,5	M10	7,9	8	64	23,0	4	MI-40G9A2M-0150			
		7,9	8	64	32,2	4	MI-40G9A2M-0150A			
1,75	M12	9,6	10	73	26,0	6	MI-60G9A2M-0175			
		9,6	10	73	36,4	6	MI-60G9A2M-0175A			
2	M16	11,4	12	84	35,0	6	MI-60G9A2M-0200			
		11,4	12	84	49,0	6	MI-60G9A2M-0200A			



ISO			Vc [m/min]	Posuw na ostrze [mm/ostrze]						
				Ø2	Ø3	Ø4	Ø6	Ø8	Ø10	Ø12
P	P10-P12	Stal stopowa, stal narzędziowa, stal do ulepszenia cieplnie do 38 HRC	70-100	0,02	0,03	0,04	0,05	0,06	0,07	0,08
	P13-P14	Stal ferrytyczna i martenzytyczna	60-90	0,02	0,03	0,03	0,04	0,05	0,06	0,06
M	M1-M2	Stal austenityczna	60-90	0,02	0,03	0,03	0,04	0,05	0,06	0,06
	M3	Stal Duplex	50-70	0,02	0,02	0,03	0,03	0,04	0,05	0,05
S	S1-S5	Nikiel i jego stopy	20-40	0,01	0,01	0,015	0,02	0,03	0,04	0,05
	S6-S8	Tytan i jego stopy	30-50	0,01	0,01	0,015	0,02	0,03	0,04	0,05
H	H1	45-50HRC	55-70	0,015	0,02	0,03	0,04	0,05	0,06	0,07
	H2	50-55HRC	40-60	0,01	0,015	0,02	0,025	0,03	0,04	0,05
	H3	55-60HRC	35-50	0,01	0,01	0,015	0,02	0,025	0,035	0,04

Uniwersalny frez do gwintów wewnętrznych i zewnętrznych, prawych oraz lewych

VHM

AT

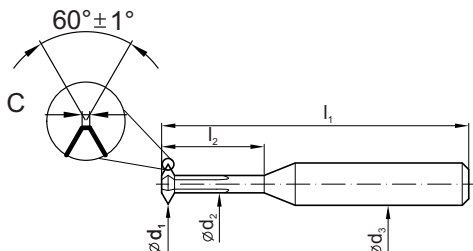

Rodzaj materiału obrabianego



Rodzaj materiału

VHM

Rodzaj powłoki

AT

Kąt zarysu gwintu

60°

Gwint	d ₁	d ₂	d ₃	l ₁	l _{2 min}	C	INDEX
M1	0,71	0,39	3,0	39	3	0,015	MI-84V002-0100U
M2	1,50	0,99	3,0	39	6	0,020	MI-84V002-0200U
M3	2,30	1,62	6,0	66	9	0,030	MI-84V002-0300U
M4	3,10	2,19	6,0	66	12	0,040	MI-84V002-0400U
M5	4,00	2,98	6,0	66	15	0,050	MI-84V002-0500U
M6	4,80	3,55	6,0	75	18	0,070	MI-84V002-0600U
M8	6,50	4,96	8,0	80	22	0,080	MI-84V002-0800U
M10	7,90	6,07	8,0	80	26	0,090	MI-84V002-1000U

	Vc (m/min)	Posuw na ostrze [mm/ostrze]					
		Ø1-Ø2	Ø3-Ø4	Ø6-Ø8	Ø10-Ø12	Ø16	
P	Rm<500	70-90	0,010	0,012	0,015	0,020	0,030
	Rm<800	50-80	0,010	0,012	0,015	0,020	0,030
	Rm<1000	45-60	0,010	0,012	0,013	0,017	0,025
	Rm<1400	40-55	0,010	0,012	0,013	0,017	0,025
M		35-50	0,007	0,010	0,010	0,015	0,020
K		40-60	0,010	0,012	0,013	0,017	0,025
N		60-180	0,012	0,012	0,015	0,020	0,030
S		25-40	0,007	0,010	0,010	0,015	0,020

Przykład zastosowań

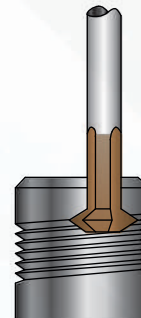
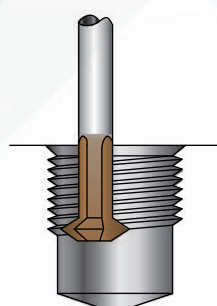
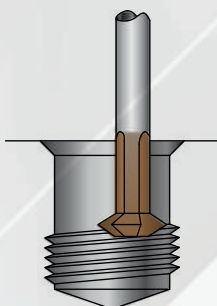

GWINTOWNIKI
RĘCZNE

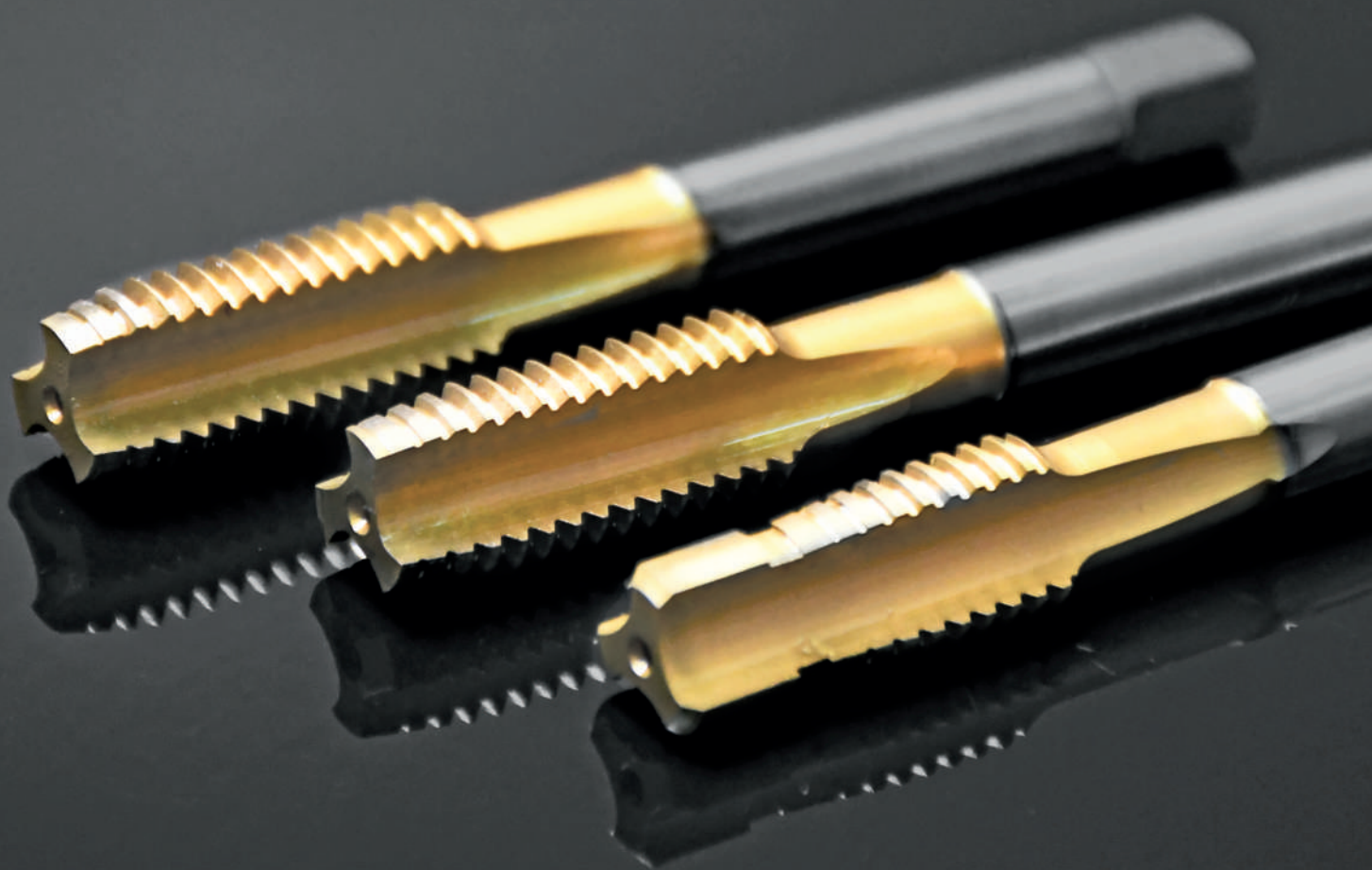

M	DIN-352	Komplety gwintowników ręcznych 3-sztukowe Komplety gwintowników ręcznych 2-sztukowe Gwintownik ręczny wykańczak F		107 - 109
	DIN-352	Komplety gwintowników ręcznych 3-sztukowe Gwintownik ręczny wykańczak F	INOX	110 - 111
	~DIN-352	Komplety gwintowników ręcznych 3-sztukowe Gwintownik ręczny wykańczak F	HRC40	112
MF	DIN-2181	Komplety gwintowników ręcznych 2-sztukowe Gwintownik ręczny wykańczak F		113 - 115
	DIN-2181	Komplety gwintowników ręcznych 2-sztukowe Gwintownik ręczny wykańczak F	HRC40	116
UNC	DIN-352	Komplety gwintowników ręcznych 3-sztukowe Gwintownik ręczny wykańczak F		117
UNF	DIN-2181	Komplety gwintowników ręcznych 2-sztukowe Gwintownik ręczny wykańczak F		118
G	DIN-5157	Komplety gwintowników ręcznych do gwintów rurowych 2-sztukowe Gwintownik ręczny wykańczak F		119
	DIN-5157	Komplety gwintowników ręcznych do gwintów rurowych 2-sztukowe Gwintownik ręczny wykańczak F	INOX	120
	DIN-5157	Komplety gwintowników ręcznych do gwintów rurowych 2-sztukowe Gwintownik ręczny wykańczak F	HRC40	121
BSW	DIN-352	Komplety gwintowników ręcznych 3-sztukowe Gwintownik ręczny wykańczak F		122
BSF	DIN-2181	Komplety gwintowników ręcznych 2-sztukowe Gwintownik ręczny wykańczak F		123

Gwint metryczny ISO DIN-13									KPL/3	KPL/2	F	
HSS DIN 352												
Rodzaj materiału obrabianego												
Typ otworu												
Rodzaj materiału									HSS			
Rodzaj powłoki												
Nakrój									~3P			
M Ød ₁	P	l ₁	l ₂	l ₃	Ød ₂	a		Norma	DIN-352			
								Tol.	ISO1 (4H)			
									INDEX	A1-230002	A1-220002	E1-131002
M1	0,25	32,5	6,5	10,5	2,5	2,10	0,75	0010	○	-	-	
M1,1	0,25	32,5	6,5	10,5	2,5	2,10	0,85	0011	○	-	-	
M1,2	0,25	32,5	6,5	10,5	2,5	2,10	0,95	0012	○	-	-	
M1,4	0,30	32,5	8,0	10,5	2,5	2,10	1,10	0014	○	-	-	
									Tol.	ISO2 (6H)		
									INDEX	A1-230001	A1-220001	E1-131001
M1,6	0,35	41,0	9,0	10,5	2,5	2,10	1,25	0016	●	-	●	
M1,7	0,35	41,0	9,0	10,5	2,5	2,10	1,35	0017	●	-	●	
M1,8	0,35	41,0	9,0	10,5	2,5	2,10	1,45	0018	●	-	●	
M2	0,40	36,0	10,0	10,0	2,8	2,10	1,60	0020	●	-	●	
M2,2	0,45	36,0	9,0	13,0	2,8	2,10	1,75	0022	●	-	●	
M2,3	0,40	36,0	9,0	13,0	2,8	2,10	1,90	0023	●	-	●	
M2,5	0,45	40,0	9,0	15,0	2,8	2,10	2,05	0025	●	-	●	
M2,6	0,45	40,0	9,0	15,0	2,8	2,10	2,15	0026	●	-	●	
M3	0,50	40,0	11,0	18,0	3,5	2,70	2,50	0030	●	●	●	
M3,5	0,60	45,0	13,0	21,0	4,0	3,00	2,90	0035	●	●	●	
M4	0,70	45,0	13,0	21,0	4,5	3,40	3,30	0040	●	●	●	
M4,5	0,75	50,0	16,0	25,0	6,0	4,90	3,70	0045	●	●	●	
M5	0,80	52,0	16,0	26,0	6,0	4,90	4,20	0050	●	●	●	
M6	1,00	56,0	18,0	27,0	6,0	4,90	5,00	0060	●	●	●	
M7	1,00	56,0	18,0	-	6,0	4,90	6,00	0070	●	●	●	
M8	1,25	63,0	20,0	-	6,0	4,90	6,80	0080	●	●	●	
M9	1,25	63,0	20,0	-	7,0	5,50	7,80	0090	●	●	●	
M10	1,50	70,0	22,0	-	7,0	5,50	8,50	0100	●	●	●	
M11	1,50	70,0	22,0	-	8,0	6,20	9,50	0110	●	●	●	
M12	1,75	80,0	24,0	-	9,0	7,00	10,20	0120	●	●	●	
M14	2,00	80,0	26,0	-	11,0	9,00	12,00	0140	●	●	●	
M16	2,00	80,0	27,0	-	12,0	9,00	14,00	0160	●	●	●	
M18	2,50	95,0	30,0	-	14,0	11,00	15,50	0180	●	●	●	
M20	2,50	95,0	32,0	-	16,0	12,00	17,50	0200	●	●	●	
M22	2,50	100,0	32,0	-	18,0	14,50	19,50	0220	●	●	●	
M24	3,00	110,0	34,0	-	18,0	14,50	21,00	0240	●	○	●	
M27	3,00	110,0	36,0	-	20,0	16,00	24,00	0270	●	○	●	



Gwint metryczny ISO DIN-13



HSS

DIN 352

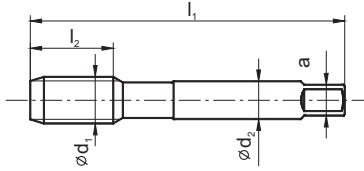

									KPL/3			KPL/2		F
									Nr1 Nr2 F			Nr1 F		F
Rodzaj materiału obrabianego														
Typ otworu														
Rodzaj materiału									HSS			HSS		HSS
Rodzaj powłoki														
Nakrój														~3P
M $\varnothing d_1$	P	l_1	l_2	l_3	$\varnothing d_2$	a		Norma	DIN-352					
								Tol.	ISO2 (6H)	ISO2 (6H)	ISO2 (6H)			
								INDEX	A1-230001	A1-220001	E1-131001			
M30	3,5	125	40	-	22	18	26,5	0300	●	-	●			
M33	3,5	125	40	-	25	20	29,5	0330	●	-	●			
M36	4,0	150	50	-	28	22	32,0	0360	●	-	●			
M39	4,0	150	50	-	32	24	35,0	0390	●	-	●			
M42	4,5	150	56	-	32	24	37,5	0420	●	-	●			
M45	4,5	160	58	-	36	29	40,5	0450	●	-	●			
M48	5,0	180	65	-	36	29	43,0	0480	●	-	●			
M52	5,0	180	65	-	40	32	47,0	0520	●	-	●			
M56	5,5	200	75	-	45	35	50,5	0560	○	-	○			
M60	5,5	200	70	-	45	35	54,5	0600	○	-	○			
M64	6,0	220	75	-	50	39	58,0	0640	○	-	○			
M68	6,0	220	75	-	50	39	62,0	0680	○	-	○			

Gwint metryczny ISO DIN-13									KPL/3-LH			KPL/2-LH			F-LH		
HSS DIN 352									Nr1 Nr2 F			Nr1 F			F		
Rodzaj materiału obrabianego																	
Typ otworu																	
Rodzaj materiału									HSS			HSS			HSS		
Rodzaj powłoki																	
Nakrój															~3P		
M Ød ₁	P	l ₁	l ₂	l ₃	Ød ₂	a		Norma	DIN-352								
								Tol.	ISO2 (6H)	ISO2 (6H)	ISO2 (6H)						
									INDEX	A1-270001	A1-260001	E1-231001					
M3	0,50	40	11	18	3,5	2,7	2,5	0030	●	●	●						
M3,5	0,60	45	13	21	4,0	3,0	2,9	0035	○	○	○						
M4	0,70	45	13	21	4,5	3,4	3,3	0040	●	●	●						
M4,5	0,75	50	16	25	6,0	4,9	3,7	0045	○	○	○						
M5	0,80	52	16	26	6,0	4,9	4,2	0050	●	●	●						
M6	1,00	56	18	27	6,0	4,9	5,0	0060	●	●	●						
M7	1,00	56	18	-	6,0	4,9	6,0	0070	○	○	○						
M8	1,25	63	20	-	6,0	4,9	6,8	0080	●	●	●						
M9	1,25	63	20	-	7,0	5,5	7,8	0090	○	○	○						
M10	1,50	70	22	-	7,0	5,5	8,5	0100	●	●	●						
M11	1,50	70	22	-	8,0	6,2	9,5	0110	○	○	○						
M12	1,75	80	24	-	9,0	7,0	10,2	0120	●	●	●						
M14	2,00	80	26	-	11,0	9,0	12,0	0140	○	○	○						
M16	2,00	80	27	-	12,0	9,0	14,0	0160	●	●	●						
M18	2,50	95	30	-	14,0	11,0	15,5	0180	○	○	○						
M20	2,50	95	32	-	16,0	12,0	17,5	0200	●	●	●						
M22	2,50	100	32	-	18,0	14,5	19,5	0220	○	○	○						
M24	3,00	110	34	-	18,0	14,5	21,0	0240	○	○	○						
M27	3,00	110	36	-	20,0	16,0	24,0	0270	○	○	○						
M30	3,50	125	40	-	22,0	18,0	26,5	0300	○	○	○						
M33	3,50	125	40	-	25,0	20,0	29,5	0330	○	○	○						
M36	4,00	150	50	-	28,0	22,0	32,0	0360	○	○	○						
M39	4,00	150	50	-	32,0	24,0	35,0	0390	○	○	○						
M42	4,50	150	56	-	32,0	24,0	37,5	0420	○	○	○						
M45	4,50	160	58	-	36,0	29,0	40,5	0450	○	○	○						
M48	5,00	180	65	-	36,0	29,0	43,0	0480	○	○	○						
M52	5,00	180	65	-	40,0	32,0	47,0	0520	○	○	○						
M56	5,50	200	75	-	40,0	32,0	50,5	0560	○	○	○						
M60	5,50	200	70	-	45,0	35,0	54,5	0600	○	○	○						
M64	6,00	220	75	-	50,0	39,0	58,0	0640	○	○	○						
M68	6,00	220	75	-	50,0	39,0	62,0	0680	○	○	○						



Gwint metryczny ISO DIN-13

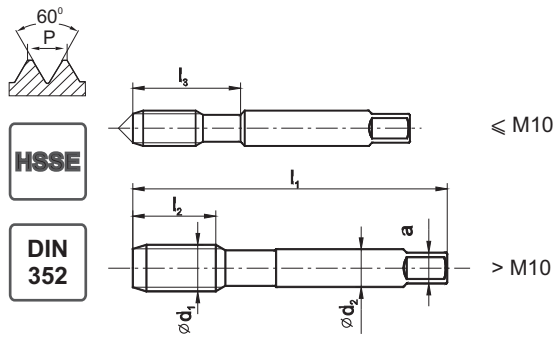

INOX

KPL/3-P

F



Nr1-P

Nr2

F

F

Rodzaj materiału obrabianego



Typ otworu



Rodzaj materiału

HSSE

HSSE

Rodzaj powłoki

Nakrój

~3P

M $\varnothing d_1$	P	l_1	l_2	l_3	$\varnothing d_2$	a		Norma	DIN-352	
								Tol.	6HX	6HX
								INDEX	A2-235801	A2-203801
M2	0,40	36	10	10	2,8	2,1	1,6	0020	●	●
M2,5	0,45	40	10	10	2,8	2,1	2,05	0025	●	●
M3	0,50	40	10	18	3,5	2,7	2,5	0030	●	●
M3,5	0,60	45	11	20	4,0	3,0	2,9	0035	○	○
M4	0,70	45	12	21	4,5	3,4	3,3	0040	●	●
M4,5	0,75	50	13	24	6,0	4,9	3,7	0045	○	○
M5	0,80	52	14	25	6,0	4,9	4,2	0050	●	●
M6	1,00	56	16	27	6,0	4,9	5,0	0060	●	●
M8	1,25	63	22		6,0	4,9	6,8	0080	●	●
M10	1,50	70	22		7,0	5,5	8,5	0100	●	●
M12	1,75	80	24		9,0	7,0	10,2	0120	●	●
M14	2,00	80	32		11,0	9,0	12,0	0140	●	●
M16	2,00	80	32		12,0	9,0	14,0	0160	●	●
M18	2,50	95	40		14,0	11,0	15,5	0180	●	●
M20	2,50	95	40		16,0	12,0	17,5	0200	●	●
M22	2,50	100	40		18,0	14,5	19,5	0220	●	●
M24	3,00	110	50		18,0	14,5	21,0	0240	●	●

4

Gwint metryczny ISO DIN-13									INOX			
									KPL/3-P	F		
Rodzaj materiału obrabianego												
Typ otworu												
Rodzaj materiału									HSSE	HSSE		
Rodzaj powłoki									TN2	TN2		
Nakrój										~3P		
M Ød ₁	P	l ₁	l ₂	l ₃	Ød ₂	a		Norma	DIN-352			
								Tol.	6HX	6HX		
								INDEX	A2-235831	A2-203831		
M2	0,40	36	10	10	2,8	2,1	1,6	0020	●	●		
M2,5	0,45	40	10	10	2,8	2,1	2,05	0025	●	●		
M3	0,50	40	10	18	3,5	2,7	2,5	0030	●	●		
M3,5	0,60	45	11	20	4,0	3,0	2,9	0035	○	○		
M4	0,70	45	12	21	4,5	3,4	3,3	0040	●	●		
M4,5	0,75	50	13	24	6,0	4,9	3,7	0045	○	○		
M5	0,80	52	14	25	6,0	4,9	4,2	0050	●	●		
M6	1,00	56	16	27	6,0	4,9	5,0	0060	●	●		
M8	1,25	63	22	-	6,0	4,9	6,8	0080	●	●		
M10	1,50	70	22	-	7,0	5,5	8,5	0100	●	●		
M12	1,75	80	24	-	9,0	7,0	10,2	0120	●	●		
M14	2,00	80	32	-	11,0	9,0	12,0	0140	●	●		
M16	2,00	80	32	-	12,0	9,0	14,0	0160	●	●		
M18	2,50	95	40	-	14,0	11,0	15,5	0180	●	●		
M20	2,50	95	40	-	16,0	12,0	17,5	0200	●	●		
M22	2,50	100	40	-	18,0	14,5	19,5	0220	●	●		
M24	3,00	110	50	-	18,0	14,5	21,0	0240	●	●		

4



Gwint metryczny ISO DIN-13

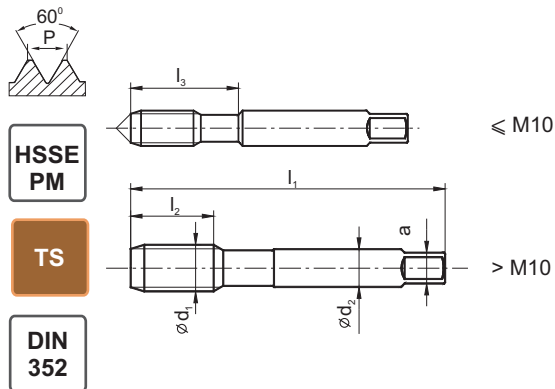

HRC40

KPL/3-P

F



Nr1-P

Nr2

F

F

Rodzaj materiału obrabianego



Typ otworu



Rodzaj materiału

HSSE-PM

HSSE-PM

Rodzaj powłoki

TS

TS

Nakrój

~3P

M Ød ₁	P	l ₁	l ₂	l ₃	Ød ₂	a		Norma	~DIN-352	
								Tol.	6HX	6HX
								INDEX	A4-235D51	A4-203D51
M3	0,50	40	10	-	3,5	2,7	2,5	0030	●	●
M4	0,70	50	13	-	6,0	4,9	3,3	0040	●	●
M5	0,80	50	16	-	6,0	4,9	4,2	0050	●	●
M6	1,00	56	19	-	6,0	4,9	5,0	0060	●	●
M8	1,25	63	22	-	6,0	4,9	6,8	0080	●	●
M10	1,50	70	25	-	7,0	5,5	8,5	0100	●	●
M12	1,75	80	30	-	9,0	7,0	10,2	0120	●	●
M16	2,00	80	32	-	12,0	9,0	14,0	0160	●	●
M20	2,50	95	40	-	16,0	12,0	17,5	0200	○	○

i

Komplet gwintowników HRC40 służy do obróbki materiałów w stanie zahartowanym do 40HRC Instrukcja poprawnego stosowania kompletu gwintowników HRC40:

1. Maksymalna głębokość gwintowania 1,5xD
2. Bezwzględnie przestrzegać kolejności pracy gwintowników w komplecie
3. Stosować wyłącznie wysokiej jakości oleje obróbkowe (np. TEREBOR oferowany przez FANAR)
4. Przed kolejnym użyciem jak najstaranniej oczyścić z wiórów gwintowniki oraz otwór gwintowany
5. Podczas gwintowania unikać cofania w celu obciążenia wióra, gwintować bez przerwy na wymaganą głębokość

Gwintownik F służy do kalibrowania gwintu w otworach wcześniej nagwintowanych, które następnie były obrabiane cieplnie, ulepszone cieplnie lub cynkowane ogniowo Instrukcja poprawnego stosowania gwintownika F:

1. Oczyścić otwór gwintowany z zanieczyszczeń
2. Zwilżyć otwór gwintowany oraz gwintownik środkiem smarnym (np. pasta CIMTAP, TEREBOR lub olej maszynowy)
3. Wprowadzić ręcznie gwintownik w otwór i przetrzeć gwint
4. Po przetarciu gwintu oczyścić i umyć gwintownik

Gwint metryczny drobnozwojny DIN-13

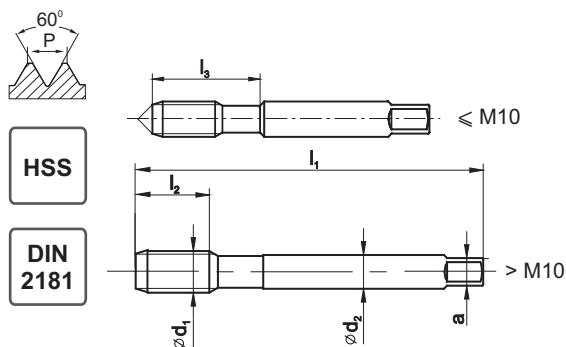

									KPL/2	F	KPL/2-LH	F-LH
									Nr1	F	Nr1	F
											↻LH	↻LH
Rodzaj materiału obrabianego												
Typ otworu												
Rodzaj materiału									HSS	HSS	HSS	HSS
Rodzaj powłoki												
Nakrój										~3P		~3P
MF Ød ₁	P	l ₁	l ₂	l ₃	Ød ₂	a		Norma	DIN-2181			
								Tol.	ISO2 (6H)	ISO2 (6H)	ISO2 (6H)	ISO2 (6H)
								INDEX	A1-220001	E1-131001	A1-260001	E1-231001
M4x0,5	0,50	45	10	18,0	4,5	3,4	3,5	0041	●	●	○	○
M4,5x0,5	0,50	50	12	22,0	6,0	4,9	4,0	0046	○	○	○	○
M5x0,5	0,50	52	13	22,0	6,0	4,9	4,5	0051	●	●	○	○
M5,5x0,5	0,50	56	13	24,0	6,0	4,9	5,0	0056	○	○	○	○
M6x0,75	0,75	56	14	24,0	6,0	4,9	5,2	0062	●	●	○	○
M7x0,75	0,75	56	14	-	6,0	4,9	6,2	0072	○	○	○	○
M8x0,75	0,75	63	14	-	6,0	4,9	7,2	0082	●	●	○	○
M8x1	1,00	63	17	-	6,0	4,9	7,0	0083	●	●	●	●
M9x0,75	0,75	63	14	-	7,0	5,5	8,2	0092	○	○	○	○
M9x1	1,00	63	17	-	7,0	5,5	8,0	0093	○	○	○	○
M10x0,75	0,75	63	18	-	7,0	5,5	9,2	0102	○	○	○	○
M10x1	1,00	63	18	-	7,0	5,5	9,0	0103	●	●	●	●
M10x1,25	1,25	70	22	-	7,0	5,5	8,8	0104	●	●	●	●
M11x0,75	0,75	63	18	-	8,0	6,2	10,2	0112	○	○	○	○
M11x1	1,00	63	18	-	8,0	6,2	10,0	0113	○	○	○	○
M12x1	1,00	70	18	-	9,0	7,0	11,0	0123	●	●	●	●
M12x1,25	1,25	70	20	-	9,0	7,0	10,8	0124	●	●	●	●
M12x1,5	1,50	70	20	-	9,0	7,0	10,5	0125	●	●	○	○
M14x1	1,00	70	18	-	11,0	9,0	13,0	0143	●	●	○	○
M14x1,25	1,25	70	22	-	11,0	9,0	12,8	0144	●	●	○	○
M14x1,5	1,50	70	22	-	11,0	9,0	12,5	0145	●	●	●	●
M15x1	1,00	70	18	-	12,0	9,0	14,0	0153	○	○	○	○
M15x1,5	1,50	70	22	-	12,0	9,0	13,5	0155	○	○	○	○
M16x1	1,00	80	18	-	12,0	9,0	15,0	0163	●	●	●	●
M16x1,25	1,25	80	18	-	12,0	9,0	14,8	0164	○	○	○	○
M16x1,5	1,50	80	22	-	12,0	9,0	14,5	0165	●	●	○	○
M17x1	1,00	80	18	-	12,0	9,0	16,0	0173	○	○	○	○
M17x1,5	1,50	80	22	-	12,0	9,0	15,5	0175	○	○	○	○
M18x1	1,00	80	18	-	14,0	11,0	17,0	0183	●	●	○	○
M18x1,5	1,50	80	22	-	14,0	11,0	16,5	0185	●	●	●	●
M18x2	2,00	80	22	-	14,0	11,0	16,0	0186	●	●	○	○
M20x1	1,00	80	18	-	16,0	12,0	19,0	0203	●	●	○	○
M20x1,5	1,50	80	22	-	16,0	12,0	18,5	0205	●	●	●	●
M20x2	2,00	80	22	-	16,0	12,0	18,0	0206	●	●	○	○
M22x1	1,00	80	18	-	18,0	14,5	21,0	0223	●	●	○	○



Gwint metryczny drobnozwojny DIN-13



HSS

DIN 2181

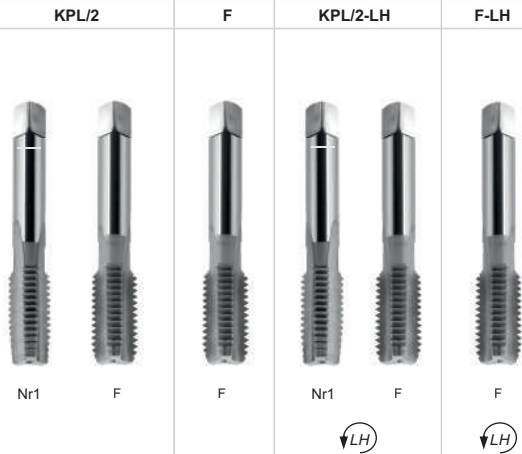
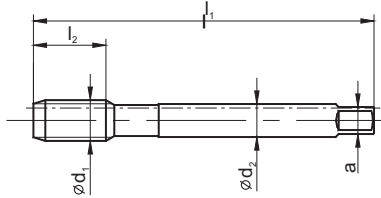

Rodzaj materiału obrabianego



Typ otworu



Rodzaj materiału

HSS HSS HSS HSS

Rodzaj powłoki

Nakrój

~3P ~3P

MF Ød ₁	P	l ₁	l ₂	l ₃	Ød ₂	a		Norma		DIN-2181			
								INDEX	ISO2 (6H)				
									A1-220001	E1-131001	A1-260001	E1-231001	
M22x1,5	1,5	80	22	-	18	14,5	20,5	0225	●	●	●	●	
M22x2	2,0	80	22	-	18	14,5	20,0	0226	●	●	○	○	
M24x1	1,0	90	18	-	18	14,5	23,0	0243	●	●	●	●	
M24x1,5	1,5	90	22	-	18	14,5	22,5	0245	●	●	○	○	
M24x2	2,0	90	22	-	18	14,5	22,0	0246	●	●	○	○	
M25x1	1,0	90	18	-	18	14,5	24,0	0253	○	○	○	○	
M25x1,5	1,5	90	22	-	18	14,5	23,5	0255	○	○	○	○	
M25x2	2,0	90	22	-	18	14,5	23,0	0256	○	○	○	○	
M26x1,5	1,5	90	22	-	18	14,5	24,5	0265	○	○	○	○	
M27x1	1,0	90	22	-	20	16,0	26,0	0273	○	○	○	○	
M27x1,5	1,5	90	22	-	20	16,0	25,5	0275	●	●	○	○	
M27x2	2,0	90	22	-	20	16,0	25,0	0276	●	●	○	○	
M28x1	1,0	90	20	-	20	16,0	27,0	0283	○	○	○	○	
M28x1,5	1,5	90	22	-	20	16,0	26,5	0285	●	●	○	○	
M28x2	2,0	90	22	-	20	16,0	26,0	0286	○	○	○	○	
M30x1	1,0	90	18	-	22	18,0	29,0	0303	○	○	○	○	
M30x1,5	1,5	90	22	-	22	18,0	28,5	0305	●	●	○	○	
M30x2	2,0	90	22	-	22	18,0	28,0	0306	●	●	○	○	
M30x3	3,0	125	36	-	22	18,0	27,0	0307	●	○	○	○	
M32x1,5	1,5	90	22	-	22	18,0	30,5	0325	○	○	○	○	
M32x2	2,0	90	22	-	22	18,0	30,0	0326	○	○	○	○	
M33x1,5	1,5	100	25	-	25	20,0	31,5	0335	●	●	○	○	
M33x2	2,0	100	25	-	25	20,0	31,0	0336	●	●	○	○	
M33x3	3,0	125	36	-	25	20,0	30,0	0337	●	●	○	○	
M35x1,5	1,5	100	25	-	28	22,0	33,5	0355	○	○	○	○	
M36x1,5	1,5	100	25	-	28	22,0	34,5	0365	○	○	○	○	
M36x2	2,0	125	30	-	28	22,0	34,0	0366	○	○	○	○	
M36x3	3,0	125	36	-	28	22,0	33,0	0367	○	○	○	○	
M38x1,5	1,5	100	25	-	28	22,0	36,5	0385	○	○	○	○	
M39x1,5	1,5	110	25	-	32	24,0	37,5	0395	○	○	○	○	
M39x2	2,0	125	30	-	32	24,0	37,0	0396	○	○	○	○	
M39x3	3,0	125	36	-	32	24,0	36,0	0397	○	○	○	○	
M40x1,5	1,5	110	25	-	32	24,0	38,5	0405	○	○	○	○	
M40x2	2,0	125	30	-	32	24,0	38,0	0406	●	●	○	○	
M40x3	3,0	125	36	-	32	24,0	37,0	0407	○	○	○	○	

Przykład zamawiania

A1-220001-0225
KPL/2 M22x1,5-6H DIN-2181 HSS● Dostępne z magazynu
○ Na zapytanie

Gwint metryczny drobnozwojny DIN-13														
									KPL/2	F	KPL/2-LH	F-LH		
HSS DIN 2181														
Rodzaj materiału obrabianego														
Typ otworu														
Rodzaj materiału									HSS	HSS	HSS	HSS		
Rodzaj powłoki														
Nakrój										~3P		~3P		
MF ød ₁	P	l ₁	l ₂	l ₃	ød ₂	a		Norma						
								DIN-2181						
								ISO2 (6H)	ISO2 (6H)	ISO2 (6H)	ISO2 (6H)	Tol.	INDEX	
M42x1,5	1,5	110	25	-	32	24	40,5	0425	●	●	○	○		
M42x2	2,0	125	30	-	32	24	40,0	0426	○	○	○	○		
M42x3	3,0	125	36	-	32	24	39,0	0427	●	●	○	○		
M42x4	4,0	150	50	-	32	24	38,0	0428	○	○	○	○		
M45x1,5	1,5	110	25	-	36	29	43,5	0455	●	●	○	○		
M45x2	2,0	125	30	-	36	29	43,0	0456	○	○	○	○		
M45x3	3,0	125	36	-	36	29	42,0	0457	●	●	○	○		
M45x4	4,0	160	50	-	36	29	41,0	0458	○	○	○	○		
M48x1,5	1,5	140	25	-	36	29	46,5	0485	○	○	○	○		
M48x2	2,0	140	30	-	36	29	46,0	0486	○	○	○	○		
M48x3	3,0	140	36	-	36	29	45,0	0487	○	○	○	○		
M48x4	4,0	180	55	-	36	29	44,0	0488	○	○	○	○		
M50x1,5	1,5	140	25	-	36	29	48,5	0505	●	●	○	○		
M50x2	2,0	140	36	-	36	29	48,0	0506	○	○	○	○		
M50x3	3,0	140	36	-	36	29	47,0	0507	●	●	○	○		
M52x1,5	1,5	140	25	-	40	32	50,5	0525	●	●	○	○		
M52x2	2,0	140	36	-	40	32,0	50,00	0526	○	○	○	○		
M52x3	3,0	140	36	-	40	32,0	49,00	0527	●	●	○	○		
M52x4	4,0	180	55	-	40	32,0	48,00	0528	○	○	○	○		



Gwint metryczny drobnozwojny DIN-13

HSSE
PM

TS

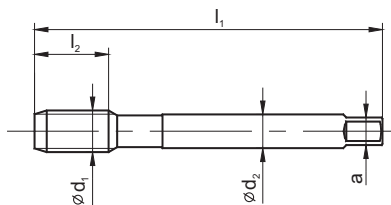
DIN
2181

HRC40

KPL/2

F



Nr1-P

F

F

Rodzaj materiału obrabianego



Typ otworu



Rodzaj materiału

HSSE-PM

HSSE-PM

Rodzaj powłoki

TS

TS

Nakrój

~3P

M Ød ₁	P	l ₁	l ₂	l ₃	Ød ₂	a		Norma		Tol.	INDEX
								DIN-2181			
M8x1	1,0	63	18	-	6	4,9	7,0	6HX	6HX		
M10x1	1,0	63	18	-	7	5,5	9,0	0083	0103	●	○
M12x1,5	1,5	70	20	-	9	7,0	10,5	0125	0165	●	●
M16x1,5	1,5	70	22	-	12	9,0	14,5	0165	0165	●	●

i

Komplet gwintowników HRC40 służy do obróbki materiałów w stanie zahartowanym do 40HRC Instrukcja poprawnego stosowania kompletu gwintowników HRC40:

1. Maksymalna głębokość gwintowania 1,5xD
2. Bezwzględnie przestrzegać kolejności pracy gwintowników w komplecie
3. Stosować wyłącznie wysokiej jakości oleje obróbkowe (np. TEREBOR oferowany przez FANAR)
4. Przed kolejnym użyciem jak najstaranniej oczyścić z wiórów gwintowniki oraz otwór gwintowany
5. Podczas gwintowania unikać cofania w celu obciążenia wióra, gwintować bez przerwy na wymaganą głębokość

Gwintownik F służy do kalibrowania gwintu w otworach wcześniej nagwintowanych, które następnie były obrabiane cieplnie, ulepszone cieplnie lub cynkowane ogniowo Instrukcja poprawnego stosowania gwintownika F:

1. Oczyścić otwór gwintowany z zanieczyszczeń
2. Zwilżyć otwór gwintowany oraz gwintownik środkiem smarnym (np. pasta CIMTAP, TEREBOR lub olej maszynowy)
3. Wprowadzić ręcznie gwintownik w otwór i przetrzeć gwint
4. Po przetarciu gwintu oczyścić i umyć gwintownik

Gwint amerykański zunifikowany UNC, ANSI B-1.1											KPL/3		F	
HSS														
DIN 352														
Rodzaj materiału obrabianego														
Typ otworu														
Rodzaj materiału											HSS		HSS	
Rodzaj powłoki														
Nakrój													~3P	
UNC	$\varnothing d_1$	1"/P	P	l_1	l_2	l_3	$\varnothing d_2$	a		Norma	DIN-352			
										Tol.	2B	2B		
										INDEX	A1-230001	E1-131001		
No2-56	2,184	56	0,454	36	10	10	2,8	2,1	1,85	4102	○	○		
No4-40	2,844	40	0,635	40	10	18	3,5	2,7	2,35	4104	●	●		
No5-40	3,175	40	0,640	42	10	18	3,5	2,7	2,65	4105	●	●		
No6-32	3,505	32	0,794	45	11	18	4,0	3,0	2,85	4106	●	●		
No8-32	4,166	32	0,794	48	12	23	4,5	3,4	3,50	4108	●	●		
No10-24	4,826	24	1,058	52	14	26	6,0	4,9	3,90	4110	●	●		
No12-24	5,486	24	1,058	56	16	27	6,0	4,9	4,50	4112	○	○		
1/4-20	6,350	20	1,270	56	16	27	6,0	4,9	5,10	4127	●	●		
5/16-18	7,938	18	1,411	63	20	-	6,0	4,9	6,60	4128	●	●		
3/8-16	9,525	16	1,588	70	22	-	7,0	5,5	8,00	4129	●	●		
7/16-14	11,112	14	1,814	70	22	-	8,0	6,2	9,40	4130	●	●		
1/2-13	12,700	13	1,954	80	25	-	9,0	7,0	10,80	4131	●	●		
9/16-12	14,288	12	2,117	80	26	-	11,0	9,0	12,20	4132	○	○		
5/8-11	15,875	11	2,309	80	27	-	12,0	9,0	13,50	4133	●	●		
3/4-10	19,050	10	2,540	95	30	-	14,0	11,0	16,50	4135	●	●		
7/8-9	22,225	9	2,822	100	32	-	18,0	14,5	19,50	4137	●	●		
1-8	25,400	8	3,175	110	36	-	18,0	14,5	22,25	4139	●	●		
1.1/8-7	28,575	7	3,629	125	40	-	22,0	18,0	25,00	4141	○	○		
1.1/4-7	31,750	7	3,629	125	40	-	22,0	18,0	28,00	4143	○	○		
1.3/8-6	34,925	6	4,233	150	50	-	28,0	22,0	30,75	4145	○	○		
1.1/2-6	38,100	6	4,233	150	50	-	28,0	22,0	34,00	4147	○	○		
1.3/4-5	44,450	5	5,080	160	58	-	36,0	29,0	39,50	4151	○	○		
2-4.1/2	50,800	4 1/2	5,645	180	70	-	40,0	32,0	45,00	4155	○	○		



**Gwint amerykański zunifikowany
drobnozwojny UNF, ANSI B-1.1**

HSS

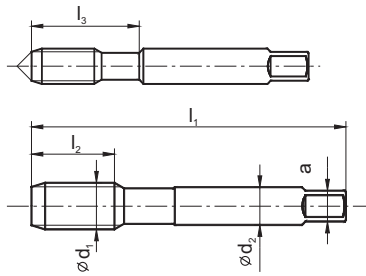
DIN
2181

Rodzaj materiału obrabianego

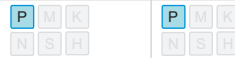

Typ otworu



Rodzaj materiału

HSS

HSS

Rodzaj powłoki

Nakrój

~3P

UNF	$\varnothing d_1$	1"/P	P	l_1	l_2	l_3	$\varnothing d_2$	a		Norma	DIN-2181					
											Tol.	2B				
										INDEX	A1-220001	E1-131001				
No 5-44	3,175	44	0,577	42	10	18	3,5	2,7	2,70	4205	○	○				
No 6-40	3,505	40	0,635	45	11	18	4,0	3,0	2,95	4206	○	○				
No 8-36	4,166	36	0,705	48	12	23	4,5	3,4	3,50	4208	○	○				
No 10-32	4,826	32	0,794	52	14	22	6,0	4,9	4,10	4210	●	●				
No 12-28	5,486	28	0,907	56	16	24	6,0	4,9	4,60	4212	○	○				
1/4-28	6,350	28	0,907	56	16	24	6,0	4,9	5,50	4227	●	●				
5/16-24	7,938	24	1,058	63	17	-	6,0	4,9	6,90	4228	○	○				
3/8-24	9,525	24	1,058	63	18	-	7,0	5,5	8,50	4229	●	●				
7/16-20	11,112	20	1,270	70	20	-	8,0	6,2	9,90	4230	●	●				
1/2-20	12,700	20	1,270	70	20	-	9,0	7,0	11,50	4231	●	●				
9/16-18	14,288	18	1,411	80	20	-	12,0	9,0	12,90	4232	●	○				
5/8-18	15,875	18	1,411	80	22	-	12,0	9,0	14,50	4233	○	○				
3/4-16	19,050	16	1,588	80	22	-	14,0	11,0	17,50	4235	●	●				
7/8-14	22,225	14	1,814	80	22	-	18,0	14,5	20,40	4237	○	○				
1-12	25,400	12	2,117	90	22	-	18,0	14,5	23,25	4239	●	●				
1.1/8-12	28,575	12	2,117	90	22	-	22,0	18,0	26,50	4241	○	○				
1.1/4-12	31,750	12	2,117	90	22	-	22,0	18,0	29,50	4243	○	○				
1.3/8-12	34,925	12	2,117	125	36	-	28,0	22,0	32,75	4245	○	○				
1.1/2-12	38,100	12	2,117	125	36	-	28,0	22,0	36,00	4247	○	○				

4

Gwint rurowy walcowy G, DIN-ISO 228																				
											KPL/2	F	KPL/2-LH	F-LH						
HSS DIN 5157											Nr1 F		F		Nr1 F		F			
Rodzaj materiału obrabianego											P M K N S H		P M K N S H		P M K N S H		P M K N S H			
Typ otworu																				
Rodzaj materiału											HSS		HSS		HSS		HSS			
Rodzaj powłoki																				
Nakrój													~3P				~3P			
											DIN-5157									
G	∅d ₁	1"/P	P	l ₁	l ₂	l ₃	∅d ₂	a		Norma										
										Toł.										
										INDEX	A1-220001	E1-131001	A1-260001	E1-231001						
G1/16	7,723	28	0,907	63	18	-	6	4,9	6,80	3121	○	○	○	○						
G1/8	9,728	28	0,907	63	20	-	7	5,5	8,80	3123	●	●	○	○						
G1/4	13,157	19	1,337	70	22	-	11	9,0	11,80	3127	●	●	○	○						
G3/8	16,662	19	1,337	70	22	-	12	9,0	15,25	3129	●	●	●	●						
G1/2	20,955	14	1,814	80	22	-	16	12,0	19,00	3131	●	●	●	●						
G5/8	22,911	14	1,814	80	22	-	18	14,5	21,00	3133	●	●	○	○						
G3/4	26,441	14	1,814	90	22	-	20	16,0	24,50	3135	●	●	●	●						
G7/8	30,201	14	1,814	90	22	-	22	18,0	28,25	3137	●	●	○	○						
G1	33,249	11	2,309	100	25	-	25	20,0	30,75	3139	●	●	●	●						
G1.1/8	37,897	11	2,309	125	36	-	28	22,0	35,50	3141	○	○	○	○						
G1.1/4	41,910	11	2,309	125	36	-	32	24,0	39,50	3143	●	●	○	○						
G1.3/8	44,323	11	2,309	125	36	-	36	29,0	41,75	3145	○	○	○	○						
G1.1/2	47,803	11	2,309	140	40	-	36	29,0	45,25	3147	●	●	○	○						
G1.3/4	53,769	11	2,309	140	40	-	40	32,0	51,00	3151	○	○	○	○						
G2	59,614	11	2,309	160	40	-	45	35,0	57,00	3155	○	○	○	○						



Gwint rurowy walcowy G, DIN-ISO 228

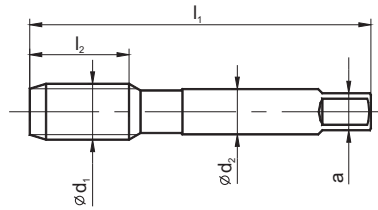

HSSE

DIN
5157

INOX

KPL/2

F



Nr1

F

F

Rodzaj materiału obrabianego



Typ otworu



< 1.5d

< 1.5d

Rodzaj materiału

HSSE

HSSE

Rodzaj powłoki

Nakrój

~3P

G	Ød ₁	1"/P	P	l ₁	l ₂	Ød ₂	a		Norma				
									DIN-5157				
									Tol.				
									INDEX	A2-225801	A2-202801		
G-1/8"	9,728	28	0,907	63	20	7	5,5	8,8	3123	○	○		
G-1/4"	13,157	19	1,337	70	22	11	9	11,8	3127	○	○		
G-3/8"	16,662	19	1,337	70	22	12	9	15,25	3129	○	○		
G-1/2"	20,955	14	1,814	80	22	16	12	19,0	3131	○	○		

4

Gwint rurowy walcowy G, DIN-ISO 228										HRC40							
										KPL/2		F					
 <div style="display: flex; flex-direction: column; align-items: flex-start;"> <div style="border: 1px solid black; padding: 2px; margin-bottom: 5px;">HSSE PM</div> <div style="border: 1px solid black; padding: 2px; margin-bottom: 5px;">TS</div> <div style="border: 1px solid black; padding: 2px;">DIN 5157</div> </div>										 Nr1 F F							
Rodzaj materiału obrabianego																	
Typ otworu										 $< 1,5d$		 $< 1,5d$					
Rodzaj materiału										HSSE-PM		HSSE-PM					
Rodzaj powłoki										TS		TS					
Nakrój												~3P					
										Norma		DIN-5157					
G										Tol.							
$\varnothing d_1$ 1"/P P l_1 l_2 $\varnothing d_2$ a										INDEX		A4-225D51		A4-202D51			
G-1/8"	9,728	28	0,907	63	20	7,0	5,5	8,80	3123	●	●						
G-1/4"	13,157	19	1,337	70	22	11,0	9,0	11,80	3127	●	●						
G-3/8"	16,662	19	1,337	70	22	12,0	9,0	15,25	3129	●	●						
G-1/2"	20,955	14	1,814	80	22	16,0	12,0	19,00	3131	●	●						



Komplet gwintowników HRC40 służy do obróbki materiałów w stanie zahartowanym do 40HRC Instrukcja poprawnego stosowania kompletu gwintowników HRC40:

1. Maksymalna głębokość gwintowania $1,5 \times D$
2. Bezwzględnie przestrzegać kolejności pracy gwintowników w komplecie
3. Stosować wyłącznie wysokiej jakości oleje obróbkowe (np. TEREBOR oferowany przez FANAR)
4. Przed kolejnym użyciem jak najstaranniej oczyścić z wiórów gwintowniki oraz otwór gwintowany
5. Podczas gwintowania unikać cofania w celu obciążenia wióra, gwintować bez przerwy na wymaganą głębokość

Gwintownik F służy do kalibrowania gwintu w otworach wcześniej nagwintowanych, które następnie były obrabiane cieplnie, ulepszone cieplnie lub cynkowane ogniowo Instrukcja poprawnego stosowania gwintownika F:

1. Oczyścić otwór gwintowany z zanieczyszczeń
2. Zwilżyć otwór gwintowany oraz gwintownik środkiem smarnym (np. pasta CIMTAP, TEREBOR lub olej maszynowy)
3. Wprowadzić ręcznie gwintownik w otwór i przetrzeć gwint
4. Po przetrzeeniu gwintu oczyścić i umyć gwintownik

**Gwint calowy zwykły Whitwortha
BSW, BS-84:1956**

HSS

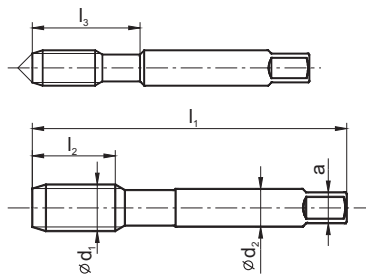
DIN
352

Rodzaj materiału obrabianego



Typ otworu



Rodzaj materiału

HSS

HSS

Rodzaj powłoki

Nakrój

~3P

BSW	Ød ₁	1"/P	P	l ₁	l ₂	l ₃	Ød ₂	a		Norma	DIN-352		
										Tol.	normal	normal	
											INDEX	A1-230001	E1-131001
1/8-40	3,180	40	0,635	42	10	18	3,5	2,7	2,55	7123	●	●	
3/16-24	4,760	24	1,058	52	14	26	6	4,9	3,70	7125	●	●	
1/4-20	6,35	20	1,270	56	16	27	6	4,9	5,10	7127	●	●	
5/16-18	7,938	18	1,411	63	20	-	6	4,9	6,50	7128	○	○	
3/8-16	9,525	16	1,588	70	22	-	7	5,5	7,90	7129	●	●	
7/16-14	11,112	14	1,814	70	22	-	8	6,2	9,25	7130	○	○	
1/2-12	12,7	12	2,117	80	25	-	9	7,0	10,50	7131	●	●	
9/16-12	14,288	12	2,117	80	26	-	11	9,0	12,00	7132	○	○	
5/8-11	15,875	11	2,309	80	27	-	12	9,0	13,50	7133	○	○	
3/4-10	19,050	10	2,504	95	30	-	14	11,0	16,40	7135	●	●	
7/8-9	22,225	9	2,822	100	32	-	18	14,5	19,25	7137	○	○	
1-8	25,400	8	3,175	110	36	-	18	14,5	22,00	7139	●	●	
1.1/8-7	28,575	7	3,629	125	40	-	22	18,0	24,75	7141	○	○	
1.1/4-7	31,750	7	3,629	125	40	-	22	18,0	27,75	7143	○	○	
1.1/2-6	38,100	6	4,233	150	50	-	28	22,0	33,50	7147	○	○	
1.3/4-5	44,450	5	5,080	160	58	-	36	29,0	39,00	7151	○	○	
2-4.1/2	50,800	4 1/2	5,645	180	70	-	40	32,0	44,50	7155	○	○	

Gwint calowy drobnozwojny Whitwortha BSF, BS-84:1956											KPL/2		F					
HSS											Nr1		F					
DIN 2181																		
Rodzaj materiału obrabianego																		
Typ otworu																		
Rodzaj materiału											HSS		HSS					
Rodzaj powłoki																		
Nakrój													~3P					
BSF	Ød ₁	1"/P	P	l ₁	l ₂	l ₃	Ød ₂	a		Norma	DIN-2181							
											Tol.	normal	normal					
										INDEX	A1-220001	E1-131001						
3/16-32	4,762	32	0,794	50	14	25	6	4,9	4,00	7225	●	●						
1/4-26	6,350	26	0,977	56	14	21	6	4,9	5,30	7227	●	●						
5/16-22	7,937	22	1,155	63	19	-	6	4,9	6,80	7228	○	○						
3/8-20	9,525	20	1,270	70	20	-	7	5,5	8,30	7229	●	●						
7/16-18	11,112	18	1,411	70	20	-	8	6,2	9,70	7230	○	○						
1/2-16	12,700	16	1,588	70	20	-	9	7,0	11,10	7231	●	●						
9/16-16	14,288	16	1,588	80	20	-	12	9,0	12,70	7232	○	○						
5/8-14	15,875	14	1,814	80	27	-	12	9,0	14,00	7233	○	○						
3/4-12	19,050	12	2,117	80	22	-	14	11,0	16,75	7235	●	●						
7/8-11	22,225	11	2,309	80	22	-	18	14,5	19,75	7237	○	○						
1-10	25,400	10	2,504	110	36	-	18	14,5	22,75	7239	●	●						



NARZYNKI



TABELA DOBORU

6

STRONY KATALOGOWE

127 - 137

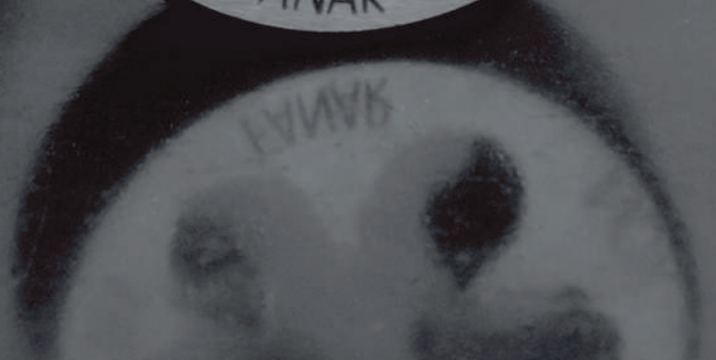
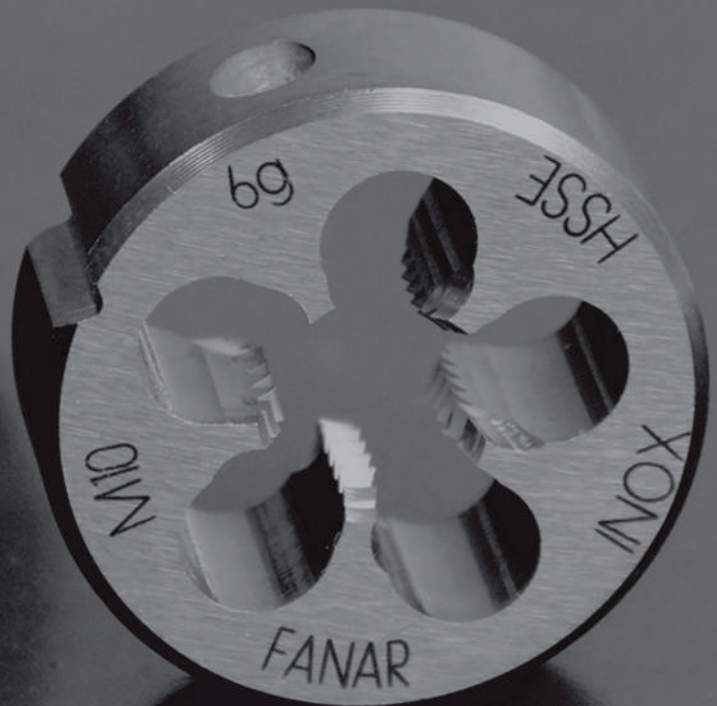
M	DIN-EN 22568	<i>800</i>	<i>800</i> SPN	<i>Ms</i>	<i>INOX</i>	127
MF	DIN-EN 22568	<i>800</i>	<i>800</i> SPN	<i>Ms</i>	<i>INOX</i>	128 - 130
UNC	DIN-EN 22568				<i>800</i>	131
UNF	DIN-EN 22568				<i>800</i>	132
G	DIN-EN 24231		<i>800</i>	<i>Ms</i>	<i>INOX</i>	133
R	DIN-EN 24230				<i>800</i>	134
BSW	DIN-EN 22568				<i>800</i>	135
BSF	DIN-EN 22568				<i>800</i>	136
NPT	DIN-EN 24230				<i>800</i>	137

Gwint metryczny ISO DIN-13						800	800 LH	800 SPN	Ms	INOX
HSS HSSE DIN-EN 22 568										
*SPN - Skośna powierzchnia natarcia										
Rodzaj materiału obrabianego						P M K N S H	P M K N S H	P M K N S H	P M K N S H	P M K N S H
Wykonanie							LH	SPN*		SPN
Rodzaj materiału						HSS	HSS	HSS	HSS	HSSE
Nakrój						1,75P	1,75P	1,75P	1,25P	2,25P
M Ø _{d₁}	P	ØDxE	W		Norma	DIN-EN 22 568				
						Tol.	6g	6g	6g	6g
					INDEX	N1-121001	N1-111001	N1-141001	N1-164001	N2-188001
M 1	0,25	16 x 5	3	0,96	0010	●	-	-	-	-
M 1,1	0,25	16 x 5	3	1,05	0011	●	-	-	-	-
M 1,2	0,25	16 x 5	3	1,15	0012	●	-	-	-	-
M 1,4	0,3	16 x 5	3	1,35	0014	●	-	-	-	-
M 1,6	0,35	16 x 5	3	1,55	0016	●	-	-	-	-
M 1,8	0,35	16 x 5	3	1,75	0018	●	-	-	-	-
M 2	0,4	16 x 5	3	1,95	0020	●	-	-	-	-
M 2,2	0,45	16 x 5	3	2,15	0022	●	-	-	-	-
M 2,5	0,45	16 x 5	3	2,42	0025	●	-	-	-	-
M 3	0,5	20 x 5	3	2,92	0030	●	●	●	●	●
M 3,5	0,6	20 x 5	3	3,41	0035	●	○	●	○	○
M 4	0,7	20 x 5	3	3,90	0040	●	●	●	●	●
M 4,5	0,75	20 x 7	3	4,40	0045	●	○	●	○	○
M 5	0,8	20 x 7	3	4,90	0050	●	●	●	●	●
M 6	1	20 x 7	4	5,88	0060	●	●	●	●	●
M 7	1	25 x 9	4	6,88	0070	●	○	●	○	○
M 8	1,25	25 x 9	4	7,86	0080	●	●	●	●	●
M 9	1,25	25 x 9	4	8,86	0090	●	○	●	○	○
M 10	1,5	30 x 11	4	9,85	0100	●	●	●	●	●
M 11	1,5	30 x 11	4	10,85	0110	●	○	●	○	○
M 12	1,75	38 x 14	4	11,83	0120	●	●	●	○	●
M 14	2	38 x 14	4	13,82	0140	●	●	●	○	●
M 16	2	45 x 18	5	15,82	0160	●	●	●	○	●
M 18	2,5	45 x 18	5	17,79	0180	●	●	●	○	●
M 20	2,5	45 x 18	5	19,79	0200	●	●	●	○	●
M 22	2,5	55 x 22	5	21,79	0220	●	●	●	○	●
M 24	3	55 x 22	5	23,76	0240	●	●	●	○	●
M 27	3	65 x 25	5	26,76	0270	●	●	●	○	●
M 30	3,5	65 x 25	6	29,73	0300	●	●	●	○	●
M 33	3,5	65 x 25	6	32,73	0330	●	●	●	○	○
M 36	4	65 x 25	7	35,70	0360	●	●	●	○	○
M 39	4	75 x 30	7	38,70	0390	●	○	○	○	○
M 42	4,5	75 x 30	7	41,68	0420	●	○	○	○	○
M 45	4,5	90 x 36	7	44,68	0450	●	○	○	○	○
M 48	5	90 x 36	7	47,66	0480	●	○	○	○	○
M 52	5	90 x 36	8	51,66	0520	●	○	○	○	○
M 56	5,5	105 x 36	7	55,65	0560	○	○	○	○	○
M 60	5,5	105 x 36	8	59,65	0600	○	○	○	○	○
M 64	6	120 x 36	7	63,62	0640	○	○	○	○	○
M 68	6	120 x 36	8	67,62	0680	○	○	○	○	○

5



Gwint metryczny drobnozwojny ISO DIN-13						800	800	800 SPN	Ms	INOX	
HSS HSSE DIN-EN 22 568											
*SPN - Skośna powierzchnia natarcia											
Rodzaj materiału obrabianego						P M K N S H	P M K N S H	P M K N S H	P M K N S H	P M K N S H	
Wykonanie							LH	SPN		SPN	
Rodzaj materiału						HSS	HSS	HSS	HSS	HSSE	
Nakrój						1,75P	1,75P	1,75P	1,25P	2,25P	
M Ød ₁	P	ØDxE	W		Norma DIN-EN 22 568						
					Tol.	6g	6g	6g	6g	6g	
						INDEX	N1-121001	N1-111001	N1-141001	N1-164001	N2-188001
M 3,5 x 0,5	0,5	20 x 5	3	3,43	0037	○	○	○	○	○	
M 4 x 0,5	0,5	20 x 5	4	3,92	0041	●	○	●	●	●	
M 4,5 x 0,5	0,5	20 x 5	4	4,43	0046	○	○	○	○	○	
M 5 x 0,5	0,5	20 x 5	4	4,92	0051	●	○	●	●	●	
M 5 x 0,75	0,75	20 x 5	4	4,91	0052	○	○	○	○	○	
M 5,5 x 0,5	0,5	20 x 5	4	5,43	0056	○	○	○	○	○	
M 5,5 x 0,75	0,75	20 x 7	4	5,42	0057	○	○	○	○	○	
M 6 x 0,5	0,5	20 x 5	4	5,92	0061	●	○	●	●	●	
M 6 x 0,75	0,75	20 x 7	4	5,90	0062	●	○	●	●	●	
M 7 x 0,75	0,75	25 x 9	4	6,90	0072	●	○	●	●	●	
M 8 x 0,5	0,5	25 x 9	4	7,92	0081	●	○	●	●	●	
M 8 x 0,75	0,75	25 x 9	4	7,90	0082	●	●	●	●	●	
M 8 x 1	1	25 x 9	4	7,88	0083	●	●	●	●	●	
M 9 x 0,75	0,75	25 x 9	4	8,90	0092	●	●	●	●	●	
M 9 x 1	1	25 x 9	4	8,88	0093	●	●	●	●	●	
M 10 x 0,75	0,75	30 x 11	4	9,90	0102	●	●	●	●	●	
M 10 x 1	1	30 x 11	5	9,88	0103	●	●	●	●	●	
M 10 x 1,25	1,25	30 x 11	4	9,86	0104	●	●	●	●	●	
M 11 x 0,75	0,75	30 x 11	5	10,91	0112	●	○	●	●	●	
M 11 x 1	1	30 x 11	4	10,88	0113	●	○	●	●	●	
M 12 x 1	1	38 x 10	4	11,88	0123	●	●	●	●	●	
M 12 x 1,25	1,25	38 x 10	4	11,86	0124	●	●	●	●	●	
M 12 x 1,5	1,5	38 x 10	4	11,85	0125	●	●	●	●	●	
M 14 x 1	1	38 x 10	5	13,88	0143	●	●	○	●	●	
M 14 x 1,5	1,5	38 x 10	5	13,85	0145	●	●	●	●	●	
M 15 x 1	1	38 x 10	5	14,88	0153	●	○	○	●	●	
M 15 x 1,5	1,5	38 x 10	5	14,85	0155	●	○	○	●	●	
M 16 x 1	1	45 x 14	5	15,88	0163	●	●	○	●	●	
M 16 x 1,5	1,5	45 x 14	5	15,85	0165	●	●	●	●	●	
M 17 x 1	1	45 x 14	5	16,88	0173	●	○	○	●	●	
M 17 x 1,5	1,5	45 x 14	5	16,85	0175	●	○	○	●	●	
M 18 x 1	1	45 x 14	5	17,88	0183	●	●	○	●	●	
M 18 x 1,5	1,5	45 x 14	5	17,85	0185	●	●	●	●	●	
M 18 x 2	2	45 x 14	5	17,82	0186	●	●	●	●	●	
M 20 x 1	1	45 x 14	6	19,80	0203	●	●	●	●	●	
M 20 x 1,5	1,5	45 x 14	6	19,85	0205	●	●	●	●	●	
M 20 x 2	2	45 x 14	6	19,82	0206	●	●	○	●	●	
M 22 x 1	1	55 x 16	6	21,88	0223	●	●	○	●	●	
M 22 x 1,5	1,5	55 x 16	6	21,85	0225	●	●	●	●	●	
M 22 x 2	2	55 x 16	6	21,82	0226	●	●	○	●	●	
M 24 x 1	1	55 x 16	6	23,88	0243	●	●	○	●	●	
M 24 x 1,5	1,5	55 x 16	6	23,85	0245	●	●	●	●	●	

5

Przykład zamawiania

N1-121001-0041
DIN-EN 22 568 M4x0,5-6g HSS 800● Dostępne z magazynu
○ Na zapytanie

Gwint metryczny drobnozwojny ISO DIN-13						800	800	800 SPN	Ms	INOX	
HSS HSSE DIN-EN 22 568											
*SPN - Skośna powierzchnia natarcia											
Rodzaj materiału obrabianego											
Wykonanie							LH	SPN		SPN	
Rodzaj materiału						HSS	HSS	HSS	HSS	HSSE	
Nakrój						1,75P	1,75P	1,75P	1,25P	2,25P	
M Ød ₁	P	ØDxE	W		Norma DIN-EN 22 568						
					Tol.	6g	6g	6g	6g	6g	
						INDEX	N1-121001	N1-111001	N1-141001	N1-164001	N2-188001
M 24 x 2	2	55 x 16	6	23,82	0246	●	●	○	○	○	
M 25 x 1	1	55 x 16	6	24,88	0253	●	○	○	○	○	
M 25 x 1,5	1,5	55 x 16	6	24,85	0255	●	○	○	○	○	
M 25 x 2	2	55 x 16	6	24,82	0256	●	○	○	○	○	
M 26 x 1,5	1,5	55 x 16	6	25,85	0265	●	○	○	○	○	
M 27 x 1	1	65 x 18	6	26,88	0273	●	○	○	○	○	
M 27 x 1,5	1,5	65 x 18	6	26,85	0275	●	○	○	○	○	
M 27 x 2	2	65 x 18	6	26,82	0276	●	○	○	○	○	
M 28 x 1	1	65 x 18	6	27,88	0283	●	○	○	○	○	
M 28 x 1,5	1,5	65 x 18	6	27,85	0285	●	○	○	○	○	
M 28 x 2	2	65 x 18	6	27,82	0286	●	○	○	○	○	
M 30 x 1	1	65 x 18	6	29,88	0303	●	○	○	○	○	
M 30 x 1,5	1,5	65 x 18	6	29,85	0305	●	○	○	○	○	
M 30 x 2	2	65 x 18	6	29,82	0306	●	○	○	○	○	
M 30 x 3	3	65 x 25	6	29,76	0307	●	○	○	○	○	
M 32 x 1,5	1,5	65 x 18	7	31,85	0325	●	○	○	○	○	
M 32 x 2	2	65 x 18	7	31,82	0326	●	○	○	○	○	
M 33 x 1,5	1,5	65 x 18	7	32,85	0335	●	○	○	○	○	
M 33 x 2	2	65 x 18	7	32,82	0336	●	○	○	○	○	
M 33 x 3	3	65 x 25	7	32,76	0337	●	○	○	○	○	
M 35 x 1,5	1,5	65 x 18	7	34,85	0355	●	○	○	○	○	
M 36 x 1,5	1,5	65 x 18	7	35,85	0365	●	○	○	○	○	
M 36 x 2	2	65 x 18	7	35,82	0366	●	○	○	○	○	
M 36 x 3	3	65 x 25	7	35,76	0367	●	○	○	○	○	
M 38 x 1,5	1,5	75 x 20	7	37,85	0385	●	○	○	○	○	
M 39 x 1,5	1,5	75 x 20	7	38,85	0395	●	○	○	○	○	
M 39 x 2	2	75 x 20	7	38,82	0396	●	○	○	○	○	
M 39 x 3	3	75 x 30	7	38,76	0397	●	○	○	○	○	
M 40 x 1,5	1,5	75 x 20	7	39,85	0405	●	○	○	○	○	
M 40 x 2	2	75 x 20	7	39,82	0406	●	○	○	○	○	
M 40 x 3	3	75 x 30	7	39,76	0407	●	○	○	○	○	
M 42 x 1,5	1,5	75 x 20	7	41,85	0425	●	○	○	○	○	
M 42 x 2	2	75 x 20	8	41,82	0426	●	○	○	○	○	
M 42 x 3	3	75 x 30	7	41,76	0427	●	○	○	○	○	
M 45 x 1,5	1,5	90 x 22	7	44,85	0455	●	○	○	○	○	
M 45 x 2	2	90 x 22	7	44,82	0456	●	○	○	○	○	
M 45 x 3	3	90 x 36	7	44,76	0457	●	○	○	○	○	
M 48 x 1,5	1,5	90 x 22	7	47,85	0485	●	○	○	○	○	
M 48 x 2	2	90 x 22	7	47,82	0486	●	○	○	○	○	
M 48 x 3	3	90 x 36	7	47,76	0487	●	○	○	○	○	
M 48 x 4	4	90 x 36	7	47,73	0488	●	○	○	○	○	
M 50 x 1,5	1,5	90 x 22	8	49,85	0505	●	○	○	○	○	



Gwint metryczny drobnozwojny ISO DIN-13						800	800	800 SPN	Ms	INOX	
<p>*SPN - Skośna powierzchnia natarcia</p>											
Rodzaj materiału obrabianego											
Wykonanie							LH	SPN		SPN	
Rodzaj materiału						HSS	HSS	HSS	HSS	HSSE	
Nakrój						1,75P	1,75P	1,75P	1,25P	2,25P	
M Ød ₁	P	ØDxE	W		Norma	DIN-EN 22 568					
					Tol.	6g	6g	6g	6g	6g	
						INDEX	N1-121001	N1-111001	N1-141001	N1-164001	N2-188001
M 50 x 2	2	90 x 22	8	49,82	0506	●	○	○	○	○	
M 50 x 3	3	90 x 36	8	49,76	0507	●	○	○	○	○	
M 52 x 1,5	1,5	90 x 22	8	51,85	0525	●	○	○	○	○	
M 52 x 2	2	90 x 22	8	51,82	0526	●	○	○	○	○	
M 52 X 3	3	90 x 36	8	51,76	0527	●	○	○	○	○	
M 52 x 4	4	90 x 36	8	51,73	0528	●	○	○	○	○	
M 55 x 1,5	1,5	105 x 22	8	54,85	0555	○	○	○	○	○	
M 55 x 2	2	105 x 22	7	54,82	0556	○	○	○	○	○	
M 55 x 3	3	105 x 36	7	54,76	0557	○	○	○	○	○	
M 55 x 4	4	105 x 36	7	54,73	0558	○	○	○	○	○	
M 56 x 1,5	2	105 x 22	8	55,85	0565	○	○	○	○	○	
M 56 x 2	2	105 x 22	8	55,82	0566	○	○	○	○	○	
M 56 x 3	3	105 x 36	8	55,76	0567	○	○	○	○	○	
M 56 x 4	4	105 x 36	7	55,73	0568	○	○	○	○	○	

Gwint amerykański zunifikowany UNC, ANSI B-1.1								800			
Rodzaj materiału obrabianego											
Wykonanie											
Rodzaj materiału								HSS			
Nakrój								1,75P			
								DIN-EN 22 568			
								2A			
								N1-121001			
UNC	Ød ₁	1"/P	P	ØD x E	W		Norma				
No 5 - 40	3,175	40	0,635	20 x 5	3	3,09	4105	●			
No 6 - 32	3,505	32	0,794	20 x 5	3	3,41	4106	●			
No 8 - 32	4,166	32	0,794	20 x 7	3	4,07	4108	●			
No 10 - 24	4,826	24	1,058	20 x 7	3	4,71	4110	●			
No 12 - 24	5,486	24	1,058	20 x 7	4	5,37	4112	●			
1/4 - 20	6,35	20	1,270	20 x 7	4	6,22	4127	●			
5/16 - 18	7,938	18	1,411	25 x 9	4	7,80	4128	●			
3/8 - 16	9,525	16	1,588	30 x 11	4	9,37	4129	●			
7/16 - 14	11,112	14	1,814	30 x 11	4	10,95	4130	●			
1/2 - 13	12,7	13	1,954	38 x 14	4	12,52	4131	●			
9/16 - 12	14,288	12	2,117	38 x 14	4	14,10	4132	●			
5/8 - 11	15,875	11	2,309	45 x 18	5	15,68	4133	●			
3/4 - 10	19,05	10	2,540	45 x 18	5	18,84	4135	●			
7/8 - 9	22,225	9	2,822	55 x 22	5	22,00	4137	●			
1 - 8	25,4	8	3,175	55 x 22	5	25,16	4139	●			
1.1/8 - 7	28,575	7	3,629	65 x 25	5	28,31	4141	○			
1.1/4 - 7	31,75	7	3,629	65 x 25	6	31,49	4143	○			
1.3/8 - 6	34,925	6	4,233	65 x 25	7	34,63	4145	○			
1.1/2 - 6	38,1	6	4,233	75 x 30	6	37,80	4147	○			
1.3/4 - 5	44,45	5	5,080	90 x 36	6	44,12	4151	○			
2 - 4.1/2	50,8	4.1/2	5,645	90 x 36	7	50,45	4155	○			

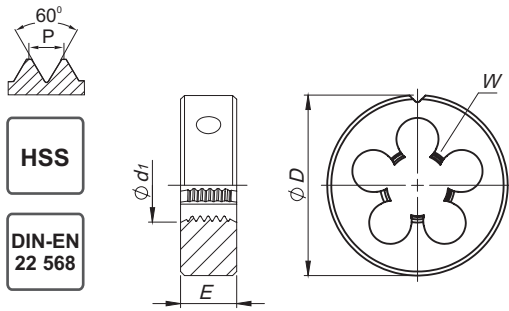

**Gwint amerykański zunifikowany
drobnozwojny UNF, ANSI B-1.1**

HSS

DIN-EN
22 568

800



Rodzaj materiału obrabianego



Wykonanie

Rodzaj materiału

HSS

Nakrój

1,75P

UNF	ϕd_1	1"/P	P	$\phi D \times E$	W		Norma			
							DIN-EN 22 568			
							Tol.			
INDEX	N1-121001									
No 5 - 44	3,175	44	0,577	20 x 5	3	3,10	4205	●		
No 6 - 40	3,505	40	0,635	20 x 5	3	3,42	4206	●		
No 8 - 36	4,166	36	0,705	20 x 7	3	4,08	4208	●		
No 10 - 32	4,826	32	0,794	20 x 7	3	4,73	4210	●		
No 12 - 28	5,486	28	0,907	20 x 7	4	5,38	4212	●		
1/4 - 28	6,35	28	0,907	20 x 7	4	6,24	4227	●		
5/16 - 24	7,938	24	1,058	25 x 9	5	7,82	4228	●		
3/8 - 24	9,525	24	1,058	30 x 11	4	9,41	4229	●		
7/16 - 20	11,112	20	1,270	30 x 11	5	10,98	4230	●		
1/2 - 20	12,7	20	1,270	38 x 10	5	12,56	4231	●		
9/16 - 18	14,288	18	1,411	38 x 10	5	14,14	4232	●		
5/8 - 18	15,875	18	1,411	45 x 14	5	15,73	4233	●		
3/4 - 16	19,05	16	1,588	45 x 14	6	18,89	4235	●		
7/8 - 14	22,225	14	1,814	55 x 16	5	22,05	4237	●		
1 - 12	25,4	12	2,117	55 x 16	6	25,21	4239	●		
1.1/8 - 12	28,575	12	2,117	65 x 18	6	28,38	4241	○		
1.1/4 - 12	31,75	12	2,117	65 x 18	6	31,55	4243	○		
1.3/8 - 12	34,925	12	2,117	65 x 18	7	34,73	4245	○		
1.1/2 - 12	38,1	12	2,117	75 x 20	8	37,90	4247	○		

5

Gwint rurowy walcowy G, DIN-ISO 228							800	800	Ms	INOX				
HSS HSSE DIN-EN 24 231														
Rodzaj materiału obrabianego							P M K N S H	P M K N S H	P M K N S H	P M K N S H				
Wykonanie								LH		SPN				
Rodzaj materiału							HSS	HSS	HSS	HSSE				
Nakrój							1,75P	1,75P	1,25P	2,25P				
G	Ød,	1"/P	P	ØD x E	W		Norma				DIN-EN 24231			
							Tol.							
							INDEX	N1-121001	N1-111001	N1-164001	N2-188001			
G1/8	9,73	28	0,907	30 x 11	4	9,62	3123	●	○	●	●			
G1/4	13,16	19	1,337	38 x 10	4	13,03	3127	●	●	●	●			
G3/8	16,66	19	1,337	45 x 14	5	16,54	3129	●	●	●	●			
G1/2	20,96	14	1,814	45 x 14	6	20,81	3131	●	●	●	●			
G5/8	22,91	14	1,814	55 x 16	5	22,77	3133	●	○	○	○			
G3/4	26,44	14	1,814	55 x 16	6	26,30	3135	●	●	●	●			
G7/8	30,20	14	1,814	65 x 18	6	30,06	3137	●	○	○	○			
G1	33,25	11	2,309	65 x 18	7	33,07	3139	●	●	●	●			
G1.1/8	37,90	11	2,309	75 x 20	7	37,72	3141	○	○	○	○			
G1.1/4	41,91	11	2,309	75 x 20	8	41,73	3143	●	○	○	○			
G1.3/8	44,32	11	2,309	90 x 22	7	44,14	3145	○	○	○	○			
G1.1/2	47,80	11	2,309	90 x 22	7	47,62	3147	●	○	○	○			
G1.3/4	53,75	11	2,309	105 x 22	8	53,57	3151	○	○	○	○			
G2	59,61	11	2,309	105 x 22	8	59,43	3155	○	○	○	○			
G2.1/4	65,71	11	2,309	120 x 22	8	65,49	3157	○	○	○	○			



Gwint calowy zwykły Whitwortha BSW, BS-84:2007								800			
Rodzaj materiału obrabianego											
Wykonanie											
Rodzaj materiału								HSS			
Nakrój								1,75P			
BSW	Ød ₁	1"/P	P	ØD x E	W		Norma	DIN-EN 22 568			
							Tol.	medium			
							INDEX	N1-121001			
1/8 - 40	3,18	40	0,635	20 x 5	3	3,09	7123	●			
3/16 - 24	4,76	24	1,058	20 x 7	4	4,66	7125	●			
1/4 - 20	6,35	20	1,270	20 x 7	4	6,24	7127	●			
5/16 - 18	7,94	18	1,411	25 x 9	4	7,82	7128	●			
3/8 - 16	9,53	16	1,588	30 x 11	4	9,40	7129	●			
7/16 - 14	11,11	14	1,814	30 x 11	4	10,98	7130	●			
1/2 - 12	12,7	12	2,117	38 x 14	4	12,56	7131	●			
9/16 - 12	14,29	12	2,117	38 x 14	4	14,14	7132	●			
5/8 - 11	15,88	11	2,309	45 x 18	5	15,72	7133	●			
3/4 - 10	19,05	10	2,540	45 x 18	5	18,89	7135	●			
7/8 - 9	22,23	9	2,822	55 x 22	5	22,10	7137	●			
1 - 8	25,4	8	3,175	55 x 22	5	25,27	7139	●			

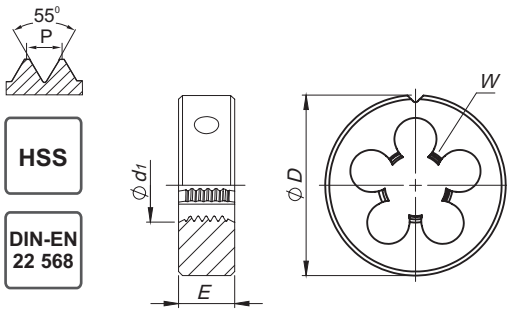

**Gwint calowy drobnozwojny Whitwortha
BSF, BS-84:2007**

800



Rodzaj materiału obrabianego



Wykonanie

Rodzaj materiału

HSS

Nakrój

1,75P

BSF	ϕd_1	1"/P	P	$\phi D \times E$	W		Norma			
							Tol.	medium		
							INDEX	N1-121001		
3/16 - 32	4,76	32	0,794	20 x 7	4	4,76	7225	●		
1/4 - 26	6,35	26	0,977	20 x 7	4	6,25	7227	●		
5/16 - 22	7,94	22	1,155	25 x 9	4	7,83	7228	●		
3/8 - 20	9,53	20	1,270	30 x 11	4	9,41	7229	●		
7/16 - 18	11,11	18	1,411	30 x 11	5	10,99	7230	●		
1/2 - 16	12,70	16	1,588	38 x 10	5	12,57	7231	●		
9/16 - 16	14,29	16	1,588	38 x 10	4	14,16	7232	●		
5/8 - 14	15,88	14	1,814	45 x 14	4	15,73	7233	●		
3/4 - 12	19,05	12	2,117	45 x 14	5	18,89	7235	●		
7/8 - 11	22,23	11	2,309	55 x 22	5	22,11	7237	●		
1 - 10	25,40	10	2,540	55 x 22	5	25,28	7239	●		

5

Gwint amerykański rurowy stożkowy NPT 1:16, ANSI B-1.20.1								800			
Rodzaj materiału obrabianego											
Wykonanie											
Rodzaj materiału								HSS			
Nakrój								2P			
NPT	Ød ₁	1"/P	P	ØD x E	W		Norma	DIN-EN 24 230			
							Tol.				
							INDEX	N1-121001			
1/8	9,728	27	0,941	30 x 11	5	9,99	4623	●			
1/4	13,157	18	1,411	38 x 14	5	13,26	4627	●			
3/8	16,662	18	1,411	45 x 18	5	16,67	4629	●			
1/2	20,955	14	1,814	45 x 18	6	20,71	4631	●			
3/4	26,441	14	1,814	55 x 22	6	26,03	4635	●			
1	33,249	11.1/2	2,209	65 x 25	7	32,59	4639	●			

5





NARZĘDZIA
WIERTARSKIE

TABELA DOBORU

7 - 8

STRONY KATALOGOWE

141 - 178

DIN-6537	Wiertła pełnowęglikowe kręte	3xD	MASTERDRILL	X-DRILL	141 - 143
	Wiertła pełnowęglikowe kręte	5xD	MASTERDRILL	X-DRILL	144 - 146
	Wiertła pełnowęglikowe kręte	8xD	MASTERDRILL		147 - 149
	Wiertła pełnowęglikowe kręte do materiałów twardych	3xD	HRC		150 - 152
	Wiertła pełnowęglikowe kręte do materiałów twardych	5xD	HRC		153 - 155
	Wiertła pełnowęglikowe kręte do metali nieżelaznych	5xD	AL		156 - 158
DIN-6539	Wiertła pełnowęglikowe kręte do małych średnic		X-DRILL		159
	Wiertła pełnowęglikowe z częścią fazującą, pod gwintowniki i wygniataki		X-DRILL		160 - 161
DIN-338	Wiertła kręte z kobaltowej stali szybko tnącej		INOX		162 - 164
	Wiertła wielostopniowe HSS		WST		165
	Wiertło do usuwania złamanych gwintowników		WDG		166
	Nawiertaki NC				167
DIN-333 A / B / R / EL	Nawiertaki do nakiełków typu A, B, R oraz w wersji długiej EL				168 - 171
	Fazowniki pełnowęglikowe				172
	Fazowniki pełnowęglikowe dwustronne do maszyn CNC				173
DIN-335-C	Pogłębiacze stożkowe z chwytem walcowym				174
DIN-335-D	Pogłębiacze stożkowe ze stożkiem Morse'a				175
	Pogłębiacze stożkowe z wymiennymi płytkami		PF		176
DIN-373	Pogłębiacze walcowo-czołowe				177
	Rozwiertaki stożkowe 1:16				178

3xD		Maksymalna głębokość wiercenia				MASTERDRILL		X-DRILL	
<div style="display: flex; justify-content: space-between; align-items: flex-start;"> <div style="width: 15%;"> <div style="border: 1px solid black; padding: 2px; margin-bottom: 5px;">VHM</div> <div style="border: 1px solid black; padding: 2px; margin-bottom: 5px;">AT</div> <div style="border: 1px solid black; padding: 2px;">DIN 6537</div> </div> <div style="width: 60%; text-align: center;"> </div> <div style="width: 20%; text-align: center;"> </div> </div>									
Rodzaj materiału obrabianego									
Wewnętrzne chłodzenie						IK		-	
Rodzaj materiału						VHM		VHM	
Powłoka						AT		AT	
Ød ₁	M MF	M "WGN"	l ₁	l ₂	Ød ₂ h6	Norma DIN-6537			
						m7			INDEX
						W9-604M33		W9-604X13	
						Tol.			
3,00			62	20	6,0	0300	●	●	
3,10			62	20	6,0	0310	○	○	
3,20			62	20	6,0	0320	●	●	
3,25		M3,5	62	20	6,0	0325	○	○	
3,30	M4		62	20	6,0	0330	●	●	
3,40			62	20	6,0	0340	○	○	
3,50	M4x0,5		62	20	6,0	0350	○	●	
3,60			62	20	6,0	0360	○	○	
3,70	M4,5	M4	62	20	6,0	0370	●	●	
3,80			66	24	6,0	0380	●	●	
3,90			66	24	6,0	0390	○	○	
4,00			66	24	6,0	0400	●	●	
4,10			66	24	6,0	0410	○	○	
4,20	M5	M4,5	66	24	6,0	0420	●	●	
4,30			66	24	6,0	0430	●	●	
4,40			66	24	6,0	0440	○	●	
4,50	M5x0,5		66	24	6,0	0450	●	●	
4,60	M5,5		66	24	6,0	0460	○	○	
4,65		M5	66	24	6,0	0465	○	○	
4,70			66	24	6,0	0470	○	○	
4,80			66	28	6,0	0480	○	○	
4,90			66	28	6,0	0490	○	○	
5,00	M6		66	28	6,0	0500	●	●	
5,10		M5,5	66	28	6,0	0510	○	●	
5,20	M6x0,75		66	28	6,0	0520	●	●	
5,30			66	28	6,0	0530	○	○	
5,40			66	28	6,0	0540	○	○	
5,50			66	28	6,0	0550	●	●	
5,60		M6	66	28	6,0	0560	○	○	
5,70			66	28	6,0	0570	○	○	
5,80			66	28	6,0	0580	○	○	
5,90			66	28	6,0	0590	○	○	
6,00	M7		66	28	6,0	0600	●	●	
6,10			79	34	8,0	0610	○	○	
6,20	M7x0,75		79	34	8,0	0620	○	○	
6,30			79	34	8,0	0630	○	○	
6,40			79	34	8,0	0640	○	○	
6,50			79	34	8,0	0650	●	●	
6,60		M7	79	34	8,0	0660	○	○	
6,70			79	34	8,0	0670	○	○	
6,80	M8		79	34	8,0	0680	●	●	
6,90			79	34	8,0	0690	○	○	
7,00	M8x1		79	34	8,0	0700	●	●	
7,10			79	41	8,0	0710	○	○	
7,20	M8x0,75		79	41	8,0	0720	○	○	
7,30			79	41	8,0	0730	○	○	



3xD Maksymalna głębokość wiercenia

MASTERDRILL

X-DRILL

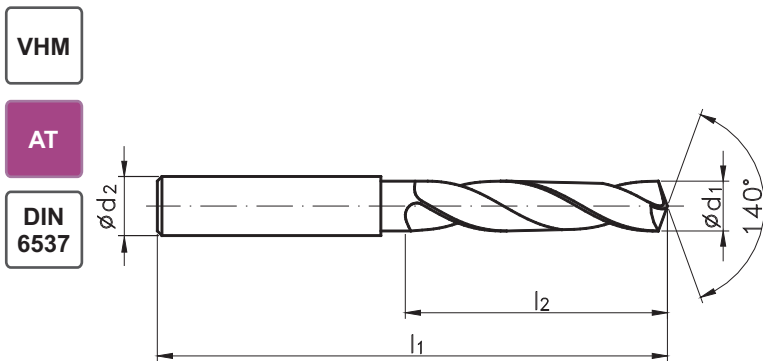

VHM
AT
DIN 6537



Rodzaj materiału obrabianego



Wewnętrzne chłodzenie

IK

-

Rodzaj materiału

VHM

VHM

Powłoka

AT

AT

Ø d ₁	M MF	M "WGN"	l ₁	l ₂	Ø d ₂ h6	Norma	DIN-6537	
						Tol.	m7	m7
						INDEX	W9-604M33	W9-604X13
7,40			79	41	8,0	0740	○	○
7,45		M8	79	41	8,0	0745	●	○
7,50			79	41	8,0	0750	○	●
7,60		M8x1	79	41	8,0	0760	●	○
7,70			79	41	8,0	0770	○	○
7,80	M9		79	41	8,0	0780	●	○
7,90			79	41	8,0	0790	○	○
8,00	M9x1		79	41	8,0	0800	●	●
8,10			89	47	10,0	0810	○	○
8,20	M9x0,75		89	47	10,0	0820	○	○
8,30			89	47	10,0	0830	○	○
8,40			89	47	10,0	0840	○	○
8,45		M9	89	47	10,0	0845	○	○
8,50	M10		89	47	10,0	0850	●	●
8,60		M9x1	89	47	10,0	0860	○	○
8,70		M9x0,75	89	47	10,0	0870	○	○
8,80	M10x1,25		89	47	10,0	0880	○	○
8,90			89	47	10,0	0890	○	○
9,00	M10x1		89	47	10,0	0900	●	●
9,10			89	47	10,0	0910	○	○
9,20	M10x0,75		89	47	10,0	0920	○	○
9,30			89	47	10,0	0930	○	○
9,35		M10	89	47	10,0	0935	●	●
9,40			89	47	10,0	0940	○	○
9,45		M10x1,25	89	47	10,0	0945	○	○
9,50	M11		89	47	10,0	0950	●	●
9,60		M10x1	89	47	10,0	0960	○	○
9,70		M10x0,75	89	47	10,0	0970	○	○
9,80			89	47	10,0	0980	●	●
9,90			89	47	10,0	0990	○	○
10,00	M11x1		89	47	10,0	1000	●	●
10,10			102	55	12,0	1010	○	○
10,20	M12		102	55	12,0	1020	●	●
10,30			102	55	12,0	1030	○	○
10,40			102	55	12,0	1040	○	○
10,50	M12x1,5		102	55	12,0	1050	●	●
10,60		M11x1	102	55	12,0	1060	○	○
10,70			102	55	12,0	1070	○	○
10,80	M12x1,25		102	55	12,0	1080	○	○
10,90			102	55	12,0	1090	○	○
11,00	M12x1		102	55	12,0	1100	●	●
11,10			102	55	12,0	1110	○	○
11,20			102	55	12,0	1120	○	○
11,25		M12	102	55	12,0	1125	○	○
11,30			102	55	12,0	1130	○	○
11,35		M12x1,5	102	55	12,0	1135	○	○

6

3xD Maksymalna głębokość wiercenia						MASTERDRILL	X-DRILL	
Rodzaj materiału obrabianego						<input type="checkbox"/> P <input type="checkbox"/> M <input type="checkbox"/> K <input type="checkbox"/> N <input type="checkbox"/> S <input type="checkbox"/> H	<input type="checkbox"/> P <input type="checkbox"/> M <input type="checkbox"/> K <input type="checkbox"/> N <input type="checkbox"/> S <input type="checkbox"/> H	
Wewnętrzne chłodzenie						IK	-	
Rodzaj materiału						VHM	VHM	
Powłoka						AT	AT	
Ø d ₁	M MF	M "WGN"	l ₁	l ₂	Ø d ₂ h6	Norma		
						DIN-6537		
						Tol.	m7	m7
						INDEX	W9-604M33	W9-604X13
11,40			102	55	12,0	1140	○	○
11,45		M12x1,25	102	55	12,0	1145	○	○
11,50			102	55	12,0	1150	●	●
11,60		M12x1	102	55	12,0	1160	○	○
11,70			102	55	12,0	1170	○	○
11,80			102	55	12,0	1180	●	●
11,90			102	55	12,0	1190	○	○
12,00	M14		102	55	12,0	1200	●	●
12,30			107	60	14,0	1230	○	○
12,50	M14x1,5		107	60	14,0	1250	●	●
12,80	M14x1,25		107	60	14,0	1280	○	○
13,00	M14x1	M14	107	60	14,0	1300	●	●
13,50			107	60	14,0	1350	●	●
13,80			107	60	14,0	1380	○	○
14,00	M16; M15x1		107	60	14,0	1400	●	●
14,50	M16x1,5		115	65	16,0	1450	●	●
14,80			115	65	16,0	1480	○	○
15,00	M16x1	M16	115	65	16,0	1500	●	●
15,35		M16x1,5	115	65	16,0	1535	○	○
15,50	M18		115	65	16,0	1550	○	○
15,80			115	65	16,0	1580	●	●
16,00	M18x2		115	65	16,0	1600	●	●
16,50	M18x1,5		123	73	18,0	1650	○	○
16,80		M18	123	73	18,0	1680	○	○
17,00	M18x1		123	73	18,0	1700	●	●
17,35		M18x1,5	123	73	18,0	1735	○	○
17,50	M20		123	73	18,0	1750	○	○
17,80			123	73	18,0	1780	○	○
18,00	M20x2		123	73	18,0	1800	●	●
18,50	M20x1,5		131	79	20,0	1850	○	○
18,80		M20	131	79	20,0	1880	○	○
19,00	M20x1		131	79	20,0	1900	○	○
19,35		M20x1,5	131	79	20,0	1935	○	○
19,50	M22		131	79	20,0	1950	○	○
19,80			131	79	20,0	1980	○	○
20,00	M22x2		131	79	20,0	2000	○	○

6



5xD

Maksymalna głębokość wiercenia

MASTERDRILL

X-DRILL

VHM

AT

DIN 6537

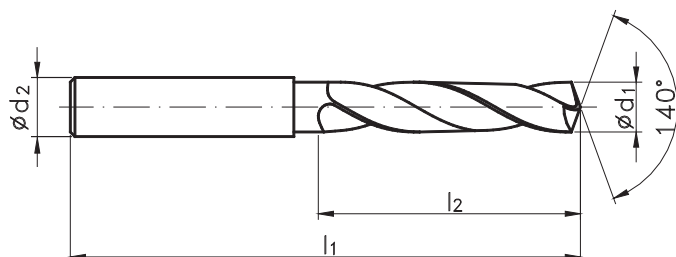

Rodzaj materiału obrabianego



Wewnętrzne chłodzenie

IK

-

Rodzaj materiału

VHM

VHM

Powłoka

AT

AT

Ø d ₁	M MF	M "WGN"	l ₁	l ₂	Ø d ₂ h6	Norma	DIN-6537	
						Tol.	m7	m7
						INDEX	W9-614M33	W9-614X13
3,00			66	28	6,0	0300	●	●
3,10			66	28	6,0	0310	○	●
3,20			66	28	6,0	0320	●	●
3,25		M3,5	66	28	6,0	0325	○	●
3,30	M4		66	28	6,0	0330	●	●
3,40			66	28	6,0	0340	○	○
3,50	M4x0,5		66	28	6,0	0350	○	●
3,60			66	28	6,0	0360	○	●
3,70	M4,5	M4	66	28	6,0	0370	●	●
3,80			74	36	6,0	0380	●	●
3,90			74	36	6,0	0390	○	○
4,00			74	36	6,0	0400	●	●
4,10			74	36	6,0	0410	○	○
4,20	M5	M4,5	74	36	6,0	0420	●	●
4,30			74	36	6,0	0430	●	●
4,40			74	36	6,0	0440	○	○
4,50	M5x0,5		74	36	6,0	0450	●	●
4,60	M5,5		74	36	6,0	0460	○	○
4,65		M5	74	36	6,0	0465	○	○
4,70			74	36	6,0	0470	○	○
4,80			82	44	6,0	0480	○	○
4,90			82	44	6,0	0490	○	○
5,00	M6		82	44	6,0	0500	●	●
5,10		M5,5	82	44	6,0	0510	○	○
5,20	M6x0,75		82	44	6,0	0520	●	●
5,30			82	44	6,0	0530	○	○
5,40			82	44	6,0	0540	○	○
5,50			82	44	6,0	0550	●	●
5,60		M6	82	44	6,0	0560	●	●
5,70			82	44	6,0	0570	○	○
5,80			82	44	6,0	0580	○	○
5,90			82	44	6,0	0590	○	○
6,00	M7		82	44	6,0	0600	●	●
6,10			91	53	8,0	0610	○	○
6,20	M7x0,75		91	53	8,0	0620	○	○
6,30			91	53	8,0	0630	○	○
6,40			91	53	8,0	0640	○	○
6,50			91	53	8,0	0650	●	●
6,60		M7	91	53	8,0	0660	○	○
6,70			91	53	8,0	0670	○	○
6,80	M8		91	53	8,0	0680	●	●
6,90			91	53	8,0	0690	○	○
7,00	M8x1		91	53	8,0	0700	●	●
7,10			91	53	8,0	0710	○	○
7,20	M8x0,75		91	53	8,0	0720	○	○
7,30			91	53	8,0	0730	○	○

6

5xD Maksymalna głębokość wiercenia						MASTERDRILL	X-DRILL	
VHM AT DIN 6537								
Rodzaj materiału obrabianego								
Wewnętrzne chłodzenie						IK	-	
Rodzaj materiału						VHM	VHM	
Powłoka						AT	AT	
Ø d ₁	M MF	M "WGN"	l ₁	l ₂	Ø d ₂ h6	Norma		
						DIN-6537		
						Tol.	m7	m7
						INDEX	W9-614M33	W9-614X13
7,40			91	53	8,0	0740	○	○
7,45		M8	91	53	8,0	0745	●	●
7,50			91	53	8,0	0750	○	○
7,60		M8x1	91	53	8,0	0760	●	●
7,70			91	53	8,0	0770	○	○
7,80	M9		91	53	8,0	0780	●	●
7,90			91	53	8,0	0790	○	○
8,00	M9x1		91	53	8,0	0800	●	●
8,10			103	61	10,0	0810	○	○
8,20	M9x0,75		103	61	10,0	0820	○	○
8,30			103	61	10,0	0830	○	○
8,40			103	61	10,0	0840	○	○
8,45		M9	103	61	10,0	0845	○	○
8,50	M10		103	61	10,0	0850	●	●
8,60		M9x1	103	61	10,0	0860	○	○
8,70		M9x0,75	103	61	10,0	0870	○	○
8,80	M10x1,25		103	61	10,0	0880	○	○
8,90			103	61	10,0	0890	○	○
9,00	M10x1		103	61	10,0	0900	●	●
9,10			103	61	10,0	0910	○	○
9,20	M10x0,75		103	61	10,0	0920	○	○
9,30			103	61	10,0	0930	○	○
9,35		M10	103	61	10,0	0935	●	●
9,40			103	61	10,0	0940	○	○
9,45		M10x1,25	103	61	10,0	0945	○	○
9,50	M11		103	61	10,0	0950	●	●
9,60		M10x1	103	61	10,0	0960	○	○
9,70		M10x0,75	103	61	10,0	0970	○	○
9,80			103	61	10,0	0980	●	●
9,90			103	61	10,0	0990	○	○
10,00	M11x1		103	61	10,0	1000	●	●
10,10			118	71	12,0	1010	○	○
10,20	M12		118	71	12,0	1020	●	●
10,30			118	71	12,0	1030	○	○
10,40			118	71	12,0	1040	○	○
10,50	M12x1,5		118	71	12,0	1050	●	●
10,60		M11x1	118	71	12,0	1060	○	○
10,70			118	71	12,0	1070	○	○
10,80	M12x1,25		118	71	12,0	1080	○	○
10,90			118	71	12,0	1090	○	○
11,00	M12x1		118	71	12,0	1100	●	●
11,10			118	71	12,0	1110	○	○
11,20			118	71	12,0	1120	○	○
11,25		M12	118	71	12,0	1125	○	○
11,30			118	71	12,0	1130	○	○
11,35		M12,1,5	118	71	12,0	1135	○	○



5xD

Maksymalna głębokość wiercenia

MASTERDRILL

X-DRILL

VHM

AT

DIN 6537

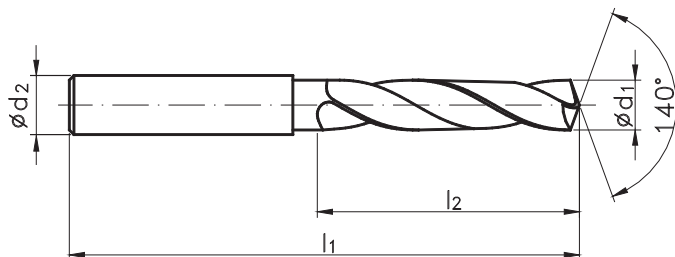

Rodzaj materiału obrabianego



Wewnętrzne chłodzenie

IK

-

Rodzaj materiału

VHM

VHM

Powłoka

AT

AT

Ø d ₁	M MF	M "WGN"	l ₁	l ₂	Ø d ₂ h6	Norma			
						DIN-6537			
						Tol.	m7		
						INDEX	W9-614M33	W9-614X13	
11,40			118	71	12,0	1140	○	○	
11,45		M12x1,25	118	71	12,0	1145	○	○	
11,50			118	71	12,0	1150	●	●	
11,60		M12x1	118	71	12,0	1160	○	○	
11,70			118	71	12,0	1170	○	○	
11,80			118	71	12,0	1180	●	●	
11,90			118	71	12,0	1190	○	○	
12,00	M14		118	71	12,0	1200	●	●	
12,30			124	77	14,0	1230	○	○	
12,50	M14x1,5		124	77	14,0	1250	●	●	
12,80	M14x1,25		124	77	14,0	1280	○	○	
13,00	M14x1	M14	124	77	14,0	1300	●	●	
13,50			124	77	14,0	1350	●	●	
13,80			124	77	14,0	1380	○	○	
14,00	M16; M15x1		124	77	14,0	1400	●	●	
14,50	M16x1,5		133	83	16,0	1450	●	●	
14,80			133	83	16,0	1480	○	○	
15,00	M16x1	M16	133	83	16,0	1500	●	●	
15,35		M16x1,5	133	83	16,0	1535	○	○	
15,50	M18		133	83	16,0	1550	○	○	
15,80			133	83	16,0	1580	●	●	
16,00	M18x2		133	83	16,0	1600	●	●	
16,50	M18x1,5		143	93	18,0	1650	○	○	
16,80		M18	143	93	18,0	1680	○	○	
17,00	M18x1		143	93	18,0	1700	●	●	
17,35		M18x1,5	143	93	18,0	1735	○	○	
17,50	M20		143	93	18,0	1750	○	○	
17,80			143	93	18,0	1780	○	○	
18,00	M20x2		143	93	18,0	1800	●	●	
18,50	M20x1,5		153	101	20,0	1850	○	○	
18,80		M20	153	101	20,0	1880	○	○	
19,00	M20x1		153	101	20,0	1900	○	○	
19,35		M20x1,5	153	101	20,0	1935	○	○	
19,50	M22		153	101	20,0	1950	○	○	
19,80			153	101	20,0	1980	○	○	
20,00	M22x2		153	101	20,0	2000	○	○	

6

8xD

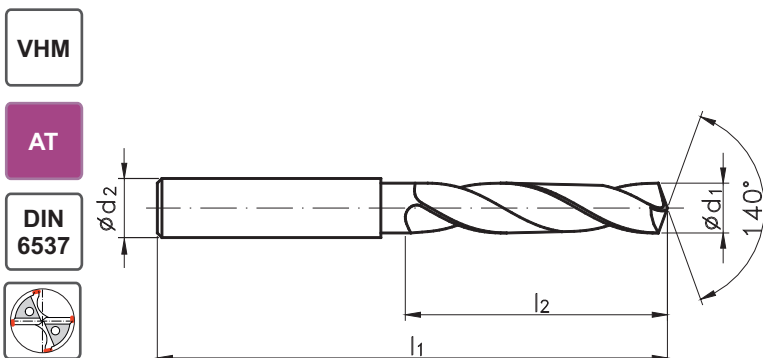
 Maksymalna głębokość wiercenia 4_{łysinki}
MASTERDRILL

VHM

AT

DIN 6537



Rodzaj materiału obrabianego



Wewnętrzne chłodzenie

IK

Rodzaj materiału

VHM

Powłoka

AT

Ø d ₁	M MF	M "WGN"	l ₁	l ₂	Ø d ₂ h6	Norma	DIN-6537		
						Tol.	m7		
						INDEX	W9-624063		
3,00			72	34	6,0	0300	o		
3,10			72	34	6,0	0310	o		
3,20			72	34	6,0	0320	o		
3,30	M4		72	34	6,0	0330	o		
3,40			72	34	6,0	0340	o		
3,50	M4x0,5		72	34	6,0	0350	o		
3,60			72	34	6,0	0360	o		
3,70	M4,5	M4	72	34	6,0	0370	o		
3,80	M4x0,5		81	43	6,0	0380	o		
3,90			81	43	6,0	0390	o		
4,00			81	43	6,0	0400	o		
4,10			81	43	6,0	0410	o		
4,20	M5	M4,5	81	43	6,0	0420	o		
4,30			81	43	6,0	0430	o		
4,40			81	43	6,0	0440	o		
4,50	M5x0,5		81	43	6,0	0450	o		
4,60	M5,5		81	43	6,0	0460	o		
4,70			81	43	6,0	0470	o		
4,80	M5x0,5		95	57	6,0	0480	o		
4,90			95	57	6,0	0490	o		
5,00	M6		95	57	6,0	0500	o		
5,10		M5,5	95	57	6,0	0510	o		
5,20	M6x0,75		95	57	6,0	0520	o		
5,30			95	57	6,0	0530	o		
5,40			95	57	6,0	0540	o		
5,50			95	57	6,0	0550	o		
5,60		M6	95	57	6,0	0560	o		
5,70	M6x0,75		95	57	6,0	0570	o		
5,80	M6x0,5		95	57	6,0	0580	o		
5,90			95	57	6,0	0590	o		
6,00	M7		95	57	6,0	0600	o		
6,10			114	76	8,0	0610	o		
6,20	M7x0,75		114	76	8,0	0620	o		
6,30			114	76	8,0	0630	o		
6,40			114	76	8,0	0640	o		
6,50			114	76	8,0	0650	o		
6,60		M7	114	76	8,0	0660	o		
6,70	M7x0,75		114	76	8,0	0670	o		
6,80	M8		114	76	8,0	0680	o		
6,90			114	76	8,0	0690	o		
7,00	M8x1		114	76	8,0	0700	o		
7,10			114	76	8,0	0710	o		
7,20	M8x0,75		114	76	8,0	0720	o		
7,30			114	76	8,0	0730	o		
7,40			114	76	8,0	0740	o		
7,50			114	76	8,0	0750	o		

6



Przykład zamawiania

 W9-624063-0300
 WK 1300 3,00 DIN-6537 8xD VHM IK AT

- Dostępne z magazynu
- Na zapytanie

 Możliwość wykonania z chwytem
 DIN-6535-HB, DIN-6535-HE

8xD

Maksymalna głębokość wiercenia 4^{lysinki}

MASTERDRILL

VHM

AT

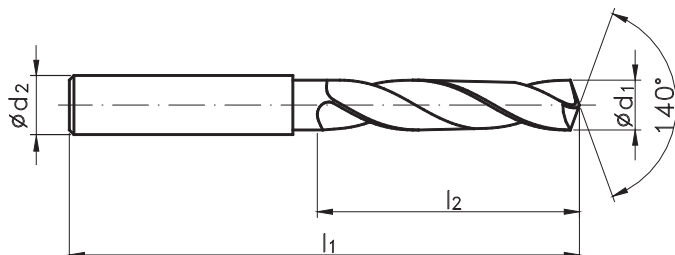
DIN
6537

Rodzaj materiału obrabianego

IK

Wewnętrzne chłodzenie

Rodzaj materiału

VHM

Powłoka

AT

Ø d ₁	M MF	M "WGN"	l ₁	l ₂	Ød ₂ h6	Norma	DIN-6537		
						Tol.	m7		
						INDEX	W9-624063		
7,60	M8x1		114	76	8,0	0760	o		
7,70	M8x0,75		114	76	8,0	0770	o		
7,80	M9		114	76	8,0	0780	o		
7,90			114	76	8,0	0790	o		
8,00	M9x1		114	76	8,0	0800	o		
8,10			142	95	10,0	0810	o		
8,20	M9x0,75		142	95	10,0	0820	o		
8,30			142	95	10,0	0830	o		
8,40			142	95	10,0	0840	o		
8,50	M10		142	95	10,0	0850	o		
8,60		M9x1	142	95	10,0	0860	o		
8,70		M9x0,75	142	95	10,0	0870	o		
8,80	M10x1,25		142	95	10,0	0880	o		
8,90			142	95	10,0	0890	o		
9,00	M10x1		142	95	10,0	0900	o		
9,10			142	95	10,0	0910	o		
9,20	M10x0,75		142	95	10,0	0920	o		
9,30			142	95	10,0	0930	o		
9,40			142	95	10,0	0940	o		
9,50	M11		142	95	10,0	0950	o		
9,60		M10x1	142	95	10,0	0960	o		
9,70		M10x0,75	142	95	10,0	0970	o		
9,80			142	95	10,0	0980	o		
9,90			142	95	10,0	0990	o		
10,00	M11x1		142	95	10,0	1000	o		
10,10			162	114	12,0	1010	o		
10,20	M12		162	114	12,0	1020	o		
10,30			162	114	12,0	1030	o		
10,40			162	114	12,0	1040	o		
10,50	M12x1,5		162	114	12,0	1050	o		
10,60		M11x1	162	114	12,0	1060	o		
10,70			162	114	12,0	1070	o		
10,80	M12x1,25		162	114	12,0	1080	o		
10,90			162	114	12,0	1090	o		
11,00	M12x1		162	114	12,0	1100	o		
11,10			162	114	12,0	1110	o		
11,20			162	114	12,0	1120	o		
11,30			162	114	12,0	1130	o		
11,40			162	114	12,0	1140	o		
11,50			162	114	12,0	1150	o		
11,60		M12x1	162	114	12,0	1160	o		
11,70			162	114	12,0	1170	o		
11,80			162	114	12,0	1180	o		
11,90			162	114	12,0	1190	o		
12,00	M14		162	114	12,0	1200	o		
12,30			178	133	14,0	1230	o		

6

8xD Maksymalna głębokość wiercenia 4 ^{lysinki}						MASTERDRILL				
<div style="display: flex; align-items: center;"> <div style="margin-right: 10px;"> <div style="border: 1px solid black; padding: 2px; width: 40px; text-align: center;">VHM</div> <div style="border: 1px solid black; padding: 2px; width: 40px; text-align: center; background-color: #800040; color: white;">AT</div> <div style="border: 1px solid black; padding: 2px; width: 40px; text-align: center;">DIN 6537</div> <div style="border: 1px solid black; padding: 2px; width: 40px; text-align: center;"> </div> </div> </div>										
Rodzaj materiału obrabianego						<div style="display: flex; justify-content: space-around;"> <div style="border: 1px solid black; padding: 2px;">P</div> <div style="border: 1px solid black; padding: 2px;">M</div> <div style="border: 1px solid black; padding: 2px;">K</div> </div> <div style="display: flex; justify-content: space-around; margin-top: 2px;"> <div style="border: 1px solid black; padding: 2px;">N</div> <div style="border: 1px solid black; padding: 2px;">S</div> <div style="border: 1px solid black; padding: 2px;">+</div> </div>				
Wewnętrzne chłodzenie						IK				
Rodzaj materiału						VHM				
Powłoka						AT				
Ø d ₁	M MF	M "WGN"	l ₁	l ₂	Ø d ₂ h6	Norma	DIN-6537			
						Tol.	m7			
						INDEX	W9-624063			
12,50	M14x1,5		178	133	14,0	1250	o			
12,80			178	133	14,0	1280	o			
13,00	M14x1		178	133	14,0	1300	o			
13,50			178	133	14,0	1350	o			
13,80			178	133	14,0	1380	o			
14,00	M16, M15x1		178	133	14,0	1400	o			
14,50	M16x1,5		203	152	16,0	1450	o			
14,80			203	152	16,0	1480	o			
15,00	M16x1		203	152	16,0	1500	o			
15,50	M18		203	152	16,0	1550	o			
15,80			203	152	16,0	1580	o			
16,00	M18x2		203	152	16,0	1600	o			
16,50	M18x1,5		222	171	18,0	1650	o			
16,80			222	171	18,0	1680	o			
17,00	M18x1		222	171	18,0	1700	o			
17,50	M20		222	171	18,0	1750	o			
17,80			222	171	18,0	1780	o			
18,00	M20x2		222	171	18,0	1800	o			
18,50	M20x1,5		243	190	20,0	1850	o			
19,00	M20x1		243	190	20,0	1900	o			
19,50	M22		243	190	20,0	1950	o			
19,80			243	190	20,0	1980	o			
20,00	M22x2		243	190	20,0	2000	o			



3xD Maksymalna głębokość wiercenia **4** łysinki
HRC

VHM

TS

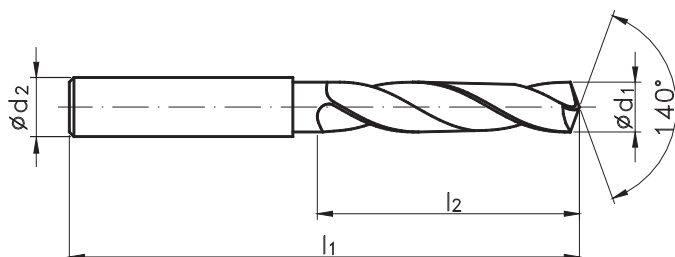
DIN
6537

Rodzaj materiału obrabianego



Wewnętrzne chłodzenie

IK

Rodzaj materiału

VHM

Powłoka

TS

Ød ₁	M MF	M "WGN"	l ₁	l ₂	Ød ₂ h6	Norma	DIN-6537
						Tol.	m7
						INDEX	W9-60G963
3,00			62	20	6,0	0300	o
3,10			62	20	6,0	0310	o
3,20			62	20	6,0	0320	o
3,25		M3,5	62	20	6,0	0325	o
3,30	M4		62	20	6,0	0330	o
3,40			62	20	6,0	0340	o
3,50	M4x0,5		62	20	6,0	0350	o
3,60			62	20	6,0	0360	o
3,70	M4,5	M4	62	20	6,0	0370	o
3,80			66	24	6,0	0380	o
3,90			66	24	6,0	0390	o
4,00			66	24	6,0	0400	o
4,10			66	24	6,0	0410	o
4,20	M5	M4,5	66	24	6,0	0420	o
4,30			66	24	6,0	0430	o
4,40			66	24	6,0	0440	o
4,50	M5x0,5		66	24	6,0	0450	o
4,60	M5,5		66	24	6,0	0460	o
4,65		M5	66	24	6,0	0465	o
4,70			66	24	6,0	0470	o
4,80			66	28	6,0	0480	o
4,90			66	28	6,0	0490	o
5,00	M6		66	28	6,0	0500	o
5,10		M5,5	66	28	6,0	0510	o
5,20	M6x0,75		66	28	6,0	0520	o
5,30			66	28	6,0	0530	o
5,40			66	28	6,0	0540	o
5,50			66	28	6,0	0550	o
5,60		M6	66	28	6,0	0560	o
5,70			66	28	6,0	0570	o
5,80			66	28	6,0	0580	o
5,90			66	28	6,0	0590	o
6,00	M7		66	28	6,0	0600	o
6,10			79	34	8,0	0610	o
6,20	M7x0,75		79	34	8,0	0620	o
6,30			79	34	8,0	0630	o
6,40			79	34	8,0	0640	o
6,50			79	34	8,0	0650	o
6,60		M7	79	34	8,0	0660	o
6,70			79	34	8,0	0670	o
6,80	M8		79	34	8,0	0680	o
6,90			79	34	8,0	0690	o
7,00	M8x1		79	34	8,0	0700	o
7,10			79	41	8,0	0710	o
7,20	M8x0,75		79	41	8,0	0720	o
7,30			79	41	8,0	0730	o

3xD Maksymalna głębokość wiercenia **4** łysinki

HRC

VHM

TS

DIN 6537

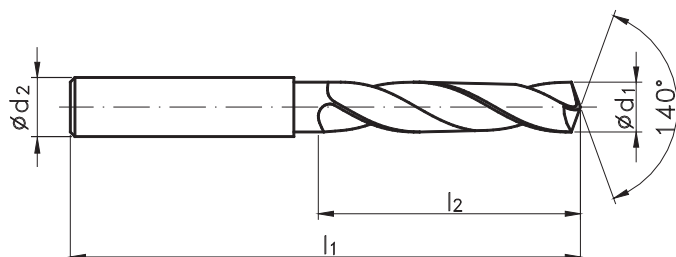

Rodzaj materiału obrabianego



Wewnętrzne chłodzenie

IK

Rodzaj materiału

VHM

Powłoka

TS

Ø d ₁	M MF	M "WGN"	l ₁	l ₂	Ø d ₂ h6	Norma	DIN-6537	
						Tol.	m7	
						INDEX	W9-60G963	
7,40			79	41	8,0	0740	o	
7,45		M8	79	41	8,0	0745	o	
7,50			79	41	8,0	0750	o	
7,60		M8x1	79	41	8,0	0760	o	
7,70			79	41	8,0	0770	o	
7,80	M9		79	41	8,0	0780	o	
7,90			79	41	8,0	0790	o	
8,00	M9x1		79	41	8,0	0800	o	
8,10			89	47	10,0	0810	o	
8,20	M9x0,75		89	47	10,0	0820	o	
8,30			89	47	10,0	0830	o	
8,40			89	47	10,0	0840	o	
8,45		M9	89	47	10,0	0845	o	
8,50	M10		89	47	10,0	0850	o	
8,60		M9x1	89	47	10,0	0860	o	
8,70		M9x0,75	89	47	10,0	0870	o	
8,80	M10x1,25		89	47	10,0	0880	o	
8,90			89	47	10,0	0890	o	
9,00	M10x1		89	47	10,0	0900	o	
9,10			89	47	10,0	0910	o	
9,20	M10x0,75		89	47	10,0	0920	o	
9,30			89	47	10,0	0930	o	
9,35		M10	89	47	10,0	0935	o	
9,40			89	47	10,0	0940	o	
9,45		M10x1,25	89	47	10,0	0945	o	
9,50	M11		89	47	10,0	0950	o	
9,60		M10x1	89	47	10,0	0960	o	
9,70		M10x0,75	89	47	10,0	0970	o	
9,80			89	47	10,0	0980	o	
9,90			89	47	10,0	0990	o	
10,00	M11x1		89	47	10,0	1000	o	
10,10			102	55	12,0	1010	o	
10,20	M12		102	55	12,0	1020	o	
10,30			102	55	12,0	1030	o	
10,40			102	55	12,0	1040	o	
10,50	M12x1,5		102	55	12,0	1050	o	
10,60		M11x1	102	55	12,0	1060	o	
10,70			102	55	12,0	1070	o	
10,80	M12x1,25		102	55	12,0	1080	o	
10,90			102	55	12,0	1090	o	
11,00	M12x1		102	55	12,0	1100	o	
11,10			102	55	12,0	1110	o	
11,20			102	55	12,0	1120	o	
11,25		M12	102	55	12,0	1125	o	
11,30			102	55	12,0	1130	o	
11,35		M12x1,5	102	55	12,0	1135	o	



Przykład zamawiania

 W9-60G963-0740
 WK HRC 3,00 DIN-6537 3xD VHM IK TS

- Dostępne z magazynu
- Na zapytanie

 Możliwość wykonania z chwytem
 DIN-6535-HB DIN-6535-HE

3xD Maksymalna głębokość wiercenia **4** lysinki

HRC

VHM

TS

DIN 6537

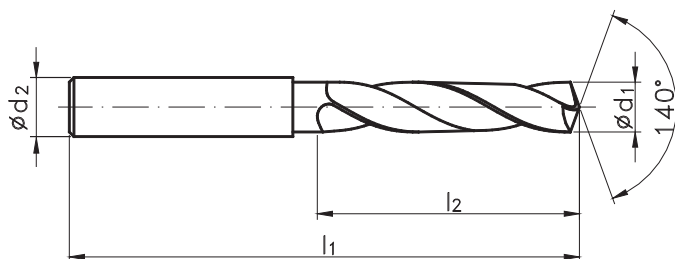

Rodzaj materiału obrabianego



Wewnętrzne chłodzenie

IK

Rodzaj materiału

VHM

Powłoka

TS

ϕd_1	M MF	M "WGN"	l_1	l_2	$\phi d_2 h_6$	Norma	
						DIN-6537	
						Tol.	m7
						INDEX	W9-60G963
11,40			102	55	12,0	1140	o
11,45		M12x1,25	102	55	12,0	1145	o
11,50			102	55	12,0	1150	o
11,60		M12x1	102	55	12,0	1160	o
11,70			102	55	12,0	1170	o
11,80			102	55	12,0	1180	o
11,90			102	55	12,0	1190	o
12,00	M14		102	55	12,0	1200	o
12,30			107	60	14,0	1230	o
12,50	M14x1,5		107	60	14,0	1250	o
12,80	M14x1,25		107	60	14,0	1280	o
13,00	M14x1	M14	107	60	14,0	1300	o
13,50			107	60	14,0	1350	o
13,80			107	60	14,0	1380	o
14,00	M16; M15x1		107	60	14,0	1400	o
14,50	M16x1,5		115	65	16,0	1450	o
14,80			115	65	16,0	1480	o
15,00	M16x1	M16	115	65	16,0	1500	o
15,35		M16x1,5	115	65	16,0	1535	o
15,50	M18		115	65	16,0	1550	o
15,80			115	65	16,0	1580	o
16,00	M18x2		115	65	16,0	1600	o
16,50	M18x1,5		123	73	18,0	1650	o
16,80		M18	123	73	18,0	1680	o
17,00	M18x1		123	73	18,0	1700	o
17,35		M18x1,5	123	73	18,0	1735	o
17,50	M20		123	73	18,0	1750	o
17,80			123	73	18,0	1780	o
18,00	M20x2		123	73	18,0	1800	o
18,50	M20x1,5		131	79	20,0	1850	o
18,80		M20	131	79	20,0	1880	o
19,00	M20x1		131	79	20,0	1900	o
19,35		M20x1,5	131	79	20,0	1935	o
19,50	M22		131	79	20,0	1950	o
19,80			131	79	20,0	1980	o
20,00	M22x2		131	79	20,0	2000	o

6

5xD Maksymalna głębokość wiercenia **4** łysinki

HRC

VHM

TS

DIN 6537

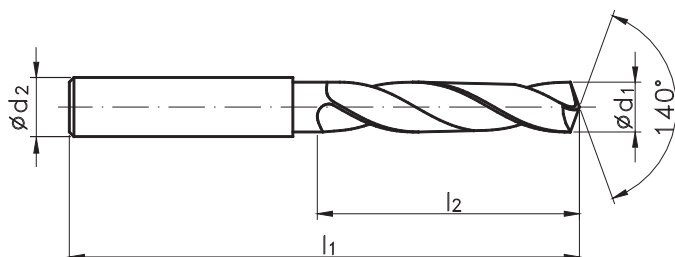

Rodzaj materiału obrabianego



Wewnętrzne chłodzenie

IK

Rodzaj materiału

VHM

Powłoka

TS

Ø d ₁	M MF	M "WGN"	l ₁	l ₂	Ø d ₂ h6	Norma	
						DIN-6537	
						Tol.	m7
						INDEX	W9-61G963
3,00			66	28	6,0	0300	o
3,10			66	28	6,0	0310	o
3,20			66	28	6,0	0320	o
3,25		M3,5	66	28	6,0	0325	o
3,30	M4		66	28	6,0	0330	o
3,40			66	28	6,0	0340	o
3,50	M4x0,5		66	28	6,0	0350	o
3,60			66	28	6,0	0360	o
3,70	M4,5	M4	66	28	6,0	0370	o
3,80			74	36	6,0	0380	o
3,90			74	36	6,0	0390	o
4,00			74	36	6,0	0400	o
4,10			74	36	6,0	0410	o
4,20	M5	M4,5	74	36	6,0	0420	o
4,30			74	36	6,0	0430	o
4,40			74	36	6,0	0440	o
4,50	M5x0,5		74	36	6,0	0450	o
4,60	M5,5		74	36	6,0	0460	o
4,65		M5	74	36	6,0	0465	o
4,70			74	36	6,0	0470	o
4,80			82	44	6,0	0480	o
4,90			82	44	6,0	0490	o
5,00	M6		82	44	6,0	0500	o
5,10		M5,5	82	44	6,0	0510	o
5,20	M6x0,75		82	44	6,0	0520	o
5,30			82	44	6,0	0530	o
5,40			82	44	6,0	0540	o
5,50			82	44	6,0	0550	o
5,60		M6	82	44	6,0	0560	o
5,70			82	44	6,0	0570	o
5,80			82	44	6,0	0580	o
5,90			82	44	6,0	0590	o
6,00	M7		82	44	6,0	0600	o
6,10			91	53	8,0	0610	o
6,20	M7x0,75		91	53	8,0	0620	o
6,30			91	53	8,0	0630	o
6,40			91	53	8,0	0640	o
6,50			91	53	8,0	0650	o
6,60		M7	91	53	8,0	0660	o
6,70			91	53	8,0	0670	o
6,80	M8		91	53	8,0	0680	o
6,90			91	53	8,0	0690	o
7,00	M8x1		91	53	8,0	0700	o
7,10			91	53	8,0	0710	o
7,20	M8x0,75		91	53	8,0	0720	o
7,30			91	53	8,0	0730	o

6



Przykład zamawiania

 W9-61G963-0300
 WK HRC 3,00 DIN-6537 5xD VHM IK TS

- Dostępne z magazynu
- Na zapytanie

 Możliwość wykonania z chwytem
 DIN-6535-HB DIN-6535-HE

5xD Maksymalna głębokość wiercenia **4** łysinki

HRC

VHM

TS

DIN 6537

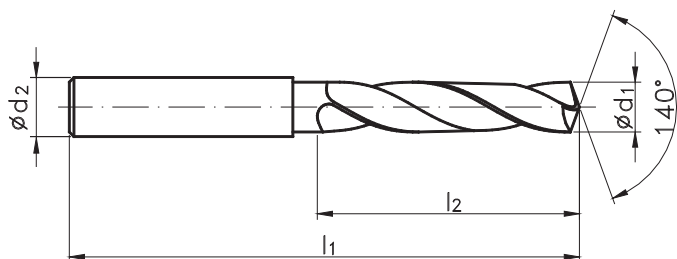

Rodzaj materiału obrabianego



Wewnętrzne chłodzenie

IK

Rodzaj materiału

VHM

Powłoka

TS

$\varnothing d_1$	M MF	M "WGN"	l_1	l_2	$\varnothing d_2, h_6$	Norma	DIN-6537	
						Tol.	m7	
						INDEX	W9-61G963	
7,40			91	53	8,0	0740	o	
7,45		M8	91	53	8,0	0745	o	
7,50			91	53	8,0	0750	o	
7,60		M8x1	91	53	8,0	0760	o	
7,70			91	53	8,0	0770	o	
7,80	M9		91	53	8,0	0780	o	
7,90			91	53	8,0	0790	o	
8,00	M9x1		91	53	8,0	0800	o	
8,10			103	61	10,0	0810	o	
8,20	M9x0,75		103	61	10,0	0820	o	
8,30			103	61	10,0	0830	o	
8,40			103	61	10,0	0840	o	
8,45		M9	103	61	10,0	0845	o	
8,50	M10		103	61	10,0	0850	o	
8,60		M9x1	103	61	10,0	0860	o	
8,70		M9x0,75	103	61	10,0	0870	o	
8,80	M10x1,25		103	61	10,0	0880	o	
8,90			103	61	10,0	0890	o	
9,00	M10x1		103	61	10,0	0900	o	
9,10			103	61	10,0	0910	o	
9,20	M10x0,75		103	61	10,0	0920	o	
9,30			103	61	10,0	0930	o	
9,35		M10	103	61	10,0	0935	o	
9,40			103	61	10,0	0940	o	
9,45		M10x1,25	103	61	10,0	0945	o	
9,50	M11		103	61	10,0	0950	o	
9,60		M10x1	103	61	10,0	0960	o	
9,70		M10x0,75	103	61	10,0	0970	o	
9,80			103	61	10,0	0980	o	
9,90			103	61	10,0	0990	o	
10,00	M11x1		103	61	10,0	1000	o	
10,10			118	71	12,0	1010	o	
10,20	M12		118	71	12,0	1020	o	
10,30			118	71	12,0	1030	o	
10,40			118	71	12,0	1040	o	
10,50	M12x1,5		118	71	12,0	1050	o	
10,60		M11x1	118	71	12,0	1060	o	
10,70			118	71	12,0	1070	o	
10,80	M12x1,25		118	71	12,0	1080	o	
10,90			118	71	12,0	1090	o	
11,00	M12x1		118	71	12,0	1100	o	
11,10			118	71	12,0	1110	o	
11,20			118	71	12,0	1120	o	
11,25		M12	118	71	12,0	1125	o	
11,30			118	71	12,0	1130	o	
11,35		M12,1,5	118	71	12,0	1135	o	

5xD Maksymalna głębokość wiercenia 4 _{lysinki}						HRC	
VHM TS DIN 6537							
Rodzaj materiału obrabianego							
Wewnętrzne chłodzenie						IK	
Rodzaj materiału						VHM	
Powłoka						TS	
Ø d ₁	M MF	M "WGN"	l ₁	l ₂	Ø d ₂ h6	Norma	
						DIN-6537	
						Tol.	m7
						INDEX	W9-61G963
11,40			118	71	12,0	1140	o
11,45		M12x1,25	118	71	12,0	1145	o
11,50			118	71	12,0	1150	o
11,60		M12x1	118	71	12,0	1160	o
11,70			118	71	12,0	1170	o
11,80			118	71	12,0	1180	o
11,90			118	71	12,0	1190	o
12,00	M14		118	71	12,0	1200	o
12,30			124	77	14,0	1230	o
12,50	M14x1,5		124	77	14,0	1250	o
12,80	M14x1,25		124	77	14,0	1280	o
13,00	M14x1	M14	124	77	14,0	1300	o
13,50			124	77	14,0	1350	o
13,80			124	77	14,0	1380	o
14,00	M16; M15x1		124	77	14,0	1400	o
14,50	M16x1,5		133	83	16,0	1450	o
14,80			133	83	16,0	1480	o
15,00	M16x1	M16	133	83	16,0	1500	o
15,35		M16x1,5	133	83	16,0	1535	o
15,50	M18		133	83	16,0	1550	o
15,80			133	83	16,0	1580	o
16,00	M18x2		133	83	16,0	1600	o
16,50	M18x1,5		143	93	18,0	1650	o
16,80		M18	143	93	18,0	1680	o
17,00	M18x1		143	93	18,0	1700	o
17,35		M18x1,5	143	93	18,0	1735	o
17,50	M20		143	93	18,0	1750	o
17,80			143	93	18,0	1780	o
18,00	M20x2		143	93	18,0	1800	o
18,50	M20x1,5		153	101	20,0	1850	o
18,80		M20	153	101	20,0	1880	o
19,00	M20x1		153	101	20,0	1900	o
19,35		M20x1,5	153	101	20,0	1935	o
19,50	M22		153	101	20,0	1950	o
19,80			153	101	20,0	1980	o
20,00	M22x2		153	101	20,0	2000	o



5xD Maksymalna głębokość wiercenia

AL

VHM

TB

DIN 6537

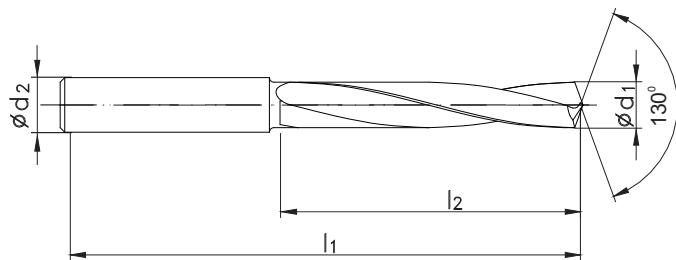

Rodzaj materiału obrabianego



Wewnętrzne chłodzenie

IK IK

Rodzaj materiału

VHM VHM

Powłoka

- TB

Ø d ₁	M MF	M MF "WGN"	l ₁	l ₂	Ød ₂ h6	Norma	DIN-6537	
						Tol.	m7	m7
						INDEX	W9-611733	W9-61B733
3,00			66	28	6,0	0300	o	o
3,10			66	28	6,0	0310	o	o
3,20			66	28	6,0	0320	o	o
3,25		M3,5	66	28	6,0	0325	o	o
3,30	M4		66	28	6,0	0330	o	o
3,40			66	28	6,0	0340	o	o
3,50	M4x0,5		66	28	6,0	0350	o	o
3,60			66	28	6,0	0360	o	o
3,70	M4,5	M4	66	28	6,0	0370	o	o
3,80			74	36	6,0	0380	o	o
3,90			74	36	6,0	0390	o	o
4,00			74	36	6,0	0400	o	o
4,10			74	36	6,0	0410	o	o
4,20	M5	M4,5	74	36	6,0	0420	o	o
4,30			74	36	6,0	0430	o	o
4,40			74	36	6,0	0440	o	o
4,50	M5x0,5		74	36	6,0	0450	o	o
4,60	M5,5		74	36	6,0	0460	o	o
4,65		M5	74	36	6,0	0465	o	o
4,70			74	36	6,0	0470	o	o
4,80			82	44	6,0	0480	o	o
4,90			82	44	6,0	0490	o	o
5,00	M6		82	44	6,0	0500	o	o
5,10		M5,5	82	44	6,0	0510	o	o
5,20	M6x0,75		82	44	6,0	0520	o	o
5,30			82	44	6,0	0530	o	o
5,40			82	44	6,0	0540	o	o
5,50			82	44	6,0	0550	o	o
5,60		M6	82	44	6,0	0560	o	o
5,70			82	44	6,0	0570	o	o
5,80			82	44	6,0	0580	o	o
5,90			82	44	6,0	0590	o	o
6,00	M7		82	44	6,0	0600	o	o
6,10			91	53	8,0	0610	o	o
6,20	M7x0,75		91	53	8,0	0620	o	o
6,30			91	53	8,0	0630	o	o
6,40			91	53	8,0	0640	o	o
6,50			91	53	8,0	0650	o	o
6,60		M7	91	53	8,0	0660	o	o
6,70			91	53	8,0	0670	o	o
6,80	M8		91	53	8,0	0680	o	o
6,90			91	53	8,0	0690	o	o
7,00	M8x1		91	53	8,0	0700	o	o
7,10			91	53	8,0	0710	o	o
7,20	M8x0,75		91	53	8,0	0720	o	o
7,30			91	53	8,0	0730	o	o

6

5xD Maksymalna głębokość wiercenia						AL													
<div style="display: flex; align-items: center;"> <div style="margin-right: 20px;"> <div style="border: 1px solid black; padding: 2px; margin-bottom: 5px;">VHM</div> <div style="border: 1px solid black; padding: 2px; margin-bottom: 5px;">TB</div> <div style="border: 1px solid black; padding: 2px;">DIN 6537</div> </div> </div>																			
Rodzaj materiału obrabianego						<table border="1"> <tr> <td>P</td><td>M</td><td>K</td> <td>P</td><td>M</td><td>K</td> </tr> <tr> <td>N</td><td>S</td><td>H</td> <td>N</td><td>S</td><td>H</td> </tr> </table>		P	M	K	P	M	K	N	S	H	N	S	H
P	M	K	P	M	K														
N	S	H	N	S	H														
Wewnętrzne chłodzenie						IK IK													
Rodzaj materiału						VHM VHM													
Powłoka						- TB													
Ø d ₁	M MF	M MF "WGN"	l ₁	l ₂	Ø d ₂ h6	Norma													
						DIN-6537													
						Tol.	m7	m7											
						INDEX	W9-611733	W9-61B733											
7,40			91	53	8,0	0740	o	o											
7,45		M8	91	53	8,0	0745	o	o											
7,50			91	53	8,0	0750	o	o											
7,60		M8x1	91	53	8,0	0760	o	o											
7,70			91	53	8,0	0770	o	o											
7,80	M9		91	53	8,0	0780	o	o											
7,90			91	53	8,0	0790	o	o											
8,00	M9x1		91	53	8,0	0800	o	o											
8,10			103	61	10,0	0810	o	o											
8,20	M9x0,75		103	61	10,0	0820	o	o											
8,30			103	61	10,0	0830	o	o											
8,40			103	61	10,0	0840	o	o											
8,45		M9	103	61	10,0	0845	o	o											
8,50	M10		103	61	10,0	0850	o	o											
8,60		M9x1	103	61	10,0	0860	o	o											
8,70		M9x0,75	103	61	10,0	0870	o	o											
8,80	M10x1,25		103	61	10,0	0880	o	o											
8,90			103	61	10,0	0890	o	o											
9,00	M10x1		103	61	10,0	0900	o	o											
9,10			103	61	10,0	0910	o	o											
9,20	M10x0,75		103	61	10,0	0920	o	o											
9,30			103	61	10,0	0930	o	o											
9,35		M10	103	61	10,0	0935	o	o											
9,40			103	61	10,0	0940	o	o											
9,45		M10x1,25	103	61	10,0	0945	o	o											
9,50	M11		103	61	10,0	0950	o	o											
9,60		M10x1	103	61	10,0	0960	o	o											
9,70		M10x0,75	103	61	10,0	0970	o	o											
9,80			103	61	10,0	0980	o	o											
9,90			103	61	10,0	0990	o	o											
10,00	M11x1		103	61	10,0	1000	o	o											
10,10			118	71	12,0	1010	o	o											
10,20	M12		118	71	12,0	1020	o	o											
10,30			118	71	12,0	1030	o	o											
10,40			118	71	12,0	1040	o	o											
10,50	M12x1,5		118	71	12,0	1050	o	o											
10,60		M11x1	118	71	12,0	1060	o	o											
10,70			118	71	12,0	1070	o	o											
10,80	M12x1,25		118	71	12,0	1080	o	o											
10,90			118	71	12,0	1090	o	o											
11,00	M12x1		118	71	12,0	1100	o	o											
11,10			118	71	12,0	1110	o	o											
11,20			118	71	12,0	1120	o	o											
11,25		M12	118	71	12,0	1125	o	o											
11,30			118	71	12,0	1130	o	o											
11,35		M12x1,5	118	71	12,0	1135	o	o											



5xD

Maksymalna głębokość wiercenia

AL

VHM

TB

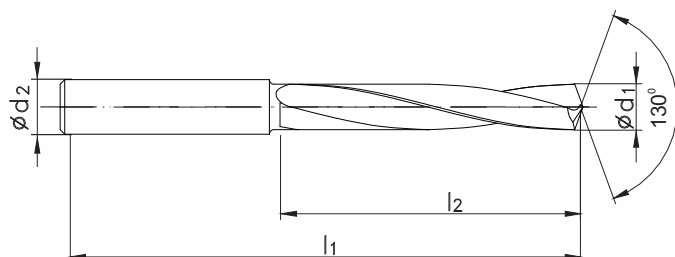
DIN
6537

Rodzaj materiału obrabianego



Wewnętrzne chłodzenie

IK

IK

Rodzaj materiału

VHM

VHM

Powłoka

-

TB

Ø d ₁	M MF	M MF "WGN"	l ₁	l ₂	Ød ₂ h6	Norma		
						DIN-6537		
						Tol.	m7	m7
						INDEX	W9-611733	W9-61B733
11,40			118	71	12,0	1140	o	o
11,45		M12x1,25	118	71	12,0	1145	o	o
11,50			118	71	12,0	1150	o	o
11,60		M12x1	118	71	12,0	1160	o	o
11,70			118	71	12,0	1170	o	o
11,80			118	71	12,0	1180	o	o
11,90			118	71	12,0	1190	o	o
12,00	M14		118	71	12,0	1200	o	o
12,30			124	77	14,0	1230	o	o
12,50	M14x1,5		124	77	14,0	1250	o	o
12,80	M14x1,25		124	77	14,0	1280	o	o
13,00	M14x1	M14	124	77	14,0	1300	o	o
13,50			124	77	14,0	1350	o	o
13,80			124	77	14,0	1380	o	o
14,00	M16; M15x1		124	77	14,0	1400	o	o
14,50	M16x1,5		133	83	16,0	1450	o	o
14,80			133	83	16,0	1480	o	o
15,00	M16x1	M16	133	83	16,0	1500	o	o
15,35		M16x1,5	133	83	16,0	1535	o	o
15,50	M18		133	83	16,0	1550	o	o
15,80			133	83	16,0	1580	o	o
16,00	M18x2		133	83	16,0	1600	o	o
16,50	M18x1,5		143	93	18,0	1650	o	o
16,80		M18	143	93	18,0	1680	o	o
17,00	M18x1		143	93	18,0	1700	o	o
17,35		M18x1,5	143	93	18,0	1735	o	o
17,50	M20		143	93	18,0	1750	o	o
17,80			143	93	18,0	1780	o	o
18,00	M20x2		143	93	18,0	1800	o	o
18,50	M20x1,5		153	101	20,0	1850	o	o
18,80		M20	153	101	20,0	1880	o	o
19,00	M20x1		153	101	20,0	1900	o	o
19,35		M20x1,5	153	101	20,0	1935	o	o
19,50	M22		153	101	20,0	1950	o	o
19,80			153	101	20,0	1980	o	o
20,00	M22x2		153	101	20,0	2000	o	o

6

					X-DRILL							
<div style="border: 1px solid black; padding: 2px; display: inline-block;">VHM</div> <div style="border: 1px solid black; padding: 2px; display: inline-block;">DIN 6539</div>												
Rodzaj materiału obrabianego					<div style="display: flex; gap: 5px;"> P M K N S H </div>							
Wewnętrzne chłodzenie					-							
Rodzaj materiału					VHM							
Powłoka					-							
ϕd_1	M MF	M "WGN"	l_1	l_2	Norma	DIN-6539						
					Tol.	h7						
					INDEX	W9-801014						
0,75	M1		22	6	0075	●						
0,85	M1,1		24	6	0085	●						
0,90		M1	24	7	0090	●						
0,95	M1,2		24	7	0095	●						
1,00		M1,1	26	7	0100	●						
1,10	M1,4		28	8	0110	●						
1,25	M1,6		30	9	0125	●						
1,28		M1,4	30	9	0128	●						
1,35	M1,7		30	9	0135	●						
1,45	M1,8		32	10	0145	●						
1,47		M1,6	32	10	0147	●						
1,57		M1,7	32	10	0157	●						
1,60	M2		34	11	0160	●						
1,67		M1,8	34	11	0167	●						
1,75	M2,2		34	11	0175	●						
1,85		M2	36	12	0185	●						
1,90	M2,3		36	12	0190	●						
2,00			38	12	0200	●						
2,03		M2,2	38	12	0203	●						
2,05	M2,5		38	12	0205	●						
2,10			38	12	0210	●						
2,15	M2,6	M2,3	38	12	0215	●						
2,20			40	13	0220	●						
2,30			40	13	0230	●						
2,33		M2,5	40	13	0233	●						
2,40			43	14	0240	●						
2,43		M2,6	43	14	0243	●						
2,50	M3		43	14	0250	●						
2,60			43	14	0260	●						
2,70			46	16	0270	●						
2,80		M3	46	16	0280	●						
2,90	M3,5		46	16	0290	●						



<div style="display: flex; align-items: center;"> <div style="margin-right: 20px;"> <div style="border: 1px solid black; padding: 2px; width: 40px; text-align: center;">VHM</div> <div style="border: 1px solid black; padding: 2px; width: 40px; text-align: center; background-color: #800040; color: white;">AT</div> <div style="border: 1px solid black; padding: 2px; width: 40px; text-align: center;">DIN 6537</div> </div> <div style="text-align: center;"> </div> <div style="margin-left: 20px;"> </div> <div style="margin-left: 20px;"> </div> </div>									
Rodzaj materiału obrabianego									
Wykonanie								90°	
Rodzaj materiału								VHM	
Powłoka								AT	
Ø d ₁	M	l ₁	l ₂	l ₃	Ø d ₂	Ø d ₂ h6	Norma	~DIN-6537	
							Tol.	m7	
							INDEX	W9-704010	
2,50	M3	66	20	8,8	6	6	0250	●	
3,30	M4	66	24	11,4	6	6	0330	●	
4,20	M5	66	28	13,6	6	6	0420	●	
5,00	M6	79	34	16,5	8	8	0500	●	
6,80	M8	89	47	21,0	10	10	0680	●	
8,50	M10	102	55	25,5	12	12	0850	●	
10,20	M12	107	60	30,0	14	14	1020	●	
12,00	M14	115	65	34,5	16	16	1200	●	
14,00	M16	123	73	38,5	18	18	1400	●	

6

<div style="display: flex; align-items: center;"> <div style="margin-right: 20px;"> <div style="border: 1px solid black; padding: 2px; width: 40px; text-align: center;">VHM</div> <div style="border: 1px solid black; padding: 2px; width: 40px; text-align: center; background-color: #800040; color: white;">AT</div> <div style="border: 1px solid black; padding: 2px; width: 40px; text-align: center;">DIN ~6537</div> </div> <div style="text-align: center;"> </div> <div style="margin-left: 20px;"> </div> </div>									
Rodzaj materiału obrabianego									
Wykonanie								90°	
Rodzaj materiału								VHM	
Powłoka								AT	
$\varnothing d_1$	M MF	l_1	l_2	l_3	$\varnothing d_2$	$\varnothing d_3, h6$	Norma	~DIN-6537	
							Tol.	m7	
							INDEX	W9-704010	
2,80	M3	62	20	12	6	6	0280	●	
3,70	M4	64	24	14	6	6	0370	●	
4,65	M5	80	28	20	6	6	0465	●	
5,55	M6	80	34	24	8	8	0555	●	
7,45	M8	80	47	30	10	10	0745	●	
9,30	M10	90	55	40	12	12	0930	●	
11,20	M12	100	60	45	14	14	1120	○	

6



HSSE

TN2

DIN 338

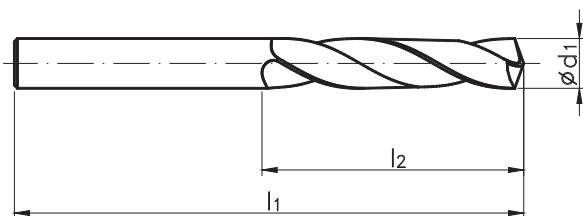

INOX



Rodzaj materiału obrabianego



Wewnętrzne chłodzenie

- -

Rodzaj materiału

HSSE HSSE

Powłoka

- TN2

$\varnothing d_1$	M MF	M MF "WGN"	l_1	l_2	Norma	DIN-338	
					Tol.	h8	h8
					INDEX	W2-101811	W2-103811
1,00		M1,1	34	12	0100	●	○
1,10	M1,4	M1,2	36	14	0110	●	○
1,20			38	16	0120	●	○
1,30			38	16	0130	●	○
1,40			40	18	0140	●	○
1,50			40	18	0150	●	○
1,60	M2		43	20	0160	●	○
1,70			43	20	0170	●	○
1,80			46	22	0180	●	○
1,83		M2	46	22	0183	○	○
1,90	M2,3		46	22	0190	●	○
2,00		M2,2	49	24	0200	●	●
2,05	M2,5		49	24	0205	○	○
2,10			49	24	0210	●	○
2,20			53	27	0220	●	○
2,30		M2,5	53	27	0230	●	○
2,40			57	30	0240	●	○
2,50	M3		57	30	0250	●	●
2,60			57	30	0260	●	○
2,70			61	33	0270	●	○
2,80		M3	61	33	0280	●	○
2,90	M3,5		61	33	0290	●	○
3,00			61	33	0300	●	●
3,10			65	36	0310	●	○
3,20			65	36	0320	●	●
3,25		M3,5	65	36	0325	○	○
3,30	M4		65	36	0330	●	●
3,40			70	39	0340	●	○
3,50	M4x0,5		70	39	0350	●	●
3,60			70	39	0360	●	○
3,70	M4,5	M4	70	39	0370	●	○
3,80			75	43	0380	●	○
3,90			75	43	0390	●	○
4,00			75	43	0400	●	●
4,10			75	43	0410	●	○
4,20	M5		75	43	0420	●	●
4,30			80	47	0430	●	○
4,40			80	47	0440	●	○
4,50	M5x0,5		80	47	0450	●	●
4,60	M5,5		80	47	0460	●	○
4,65		M5	80	47	0465	○	○
4,70			80	47	0470	●	○
4,80			86	52	0480	●	○
4,90			86	52	0490	●	○
5,00	M6		86	52	0500	●	●
5,10			86	52	0510	●	●

6

					INOX																
<div style="display: flex; flex-direction: column; align-items: flex-start;"> <div style="border: 1px solid black; padding: 2px; margin-bottom: 5px;">HSSE</div> <div style="border: 1px solid black; padding: 2px; margin-bottom: 5px;">TN2</div> <div style="border: 1px solid black; padding: 2px;">DIN 338</div> </div>																					
Rodzaj materiału obrabianego					<table border="1"> <tr> <td>P</td><td>M</td><td>K</td> <td>P</td><td>M</td><td>K</td> </tr> <tr> <td>N</td><td>S</td><td>H</td> <td>N</td><td>S</td><td>H</td> </tr> </table>		P	M	K	P	M	K	N	S	H	N	S	H			
P	M	K	P	M	K																
N	S	H	N	S	H																
Wewnętrzne chłodzenie					-																
Rodzaj materiału					HSSE		HSSE														
Powłoka					-		TN2														
$\varnothing d_1$	M MF	M MF "WGN"	l_1	l_2	Norma	DIN-338															
					Tol.	h8	h8														
					INDEX	W2-101811	W2-103811														
5,20	M6x0,75		86	52	0520	●	○														
5,30			86	52	0530	●	○														
5,40			93	57	0540	●	○														
5,50			93	57	0550	●	●														
5,55			93	57	0555	○	○														
5,60		M6	93	57	0560	●	○														
5,70			93	57	0570	●	○														
5,80			93	57	0580	●	○														
5,90			93	57	0590	●	○														
6,00	M7		93	57	0600	●	●														
6,10			101	63	0610	●	○														
6,20	M7x0,75		101	63	0620	●	○														
6,30			101	63	0630	●	○														
6,40			101	63	0640	●	○														
6,50			101	63	0650	●	●														
6,60		M7	101	63	0660	●	○														
6,70			101	63	0670	●	○														
6,80	M8		109	69	0680	●	●														
6,90			109	69	0690	●	●														
7,00	M8x1		109	69	0700	●	●														
7,10			109	69	0710	●	○														
7,20	M8x0,75		109	69	0720	●	○														
7,30			109	69	0730	●	○														
7,40		M8	109	69	0740	●	○														
7,50			109	69	0750	●	●														
7,60			117	75	0760	●	○														
7,70			117	75	0770	●	○														
7,80	M9		117	75	0780	●	○														
7,90			117	75	0790	●	○														
8,00	M9x1		117	75	0800	●	●														
8,10			117	75	0810	●	○														
8,20	M9x0,75		117	75	0820	●	●														
8,30			117	75	0830	●	○														
8,40			117	75	0840	●	○														
8,50	M10		117	75	0850	●	●														
8,60			125	81	0860	●	○														
8,70			125	81	0870	●	○														
8,80	M10x1,25		125	81	0880	●	○														
8,90			125	81	0890	●	○														
9,00	M10x1		125	81	0900	●	●														
9,10			125	81	0910	●	○														
9,20	M10x0,75		125	81	0920	●	○														
9,30		M10	125	81	0930	●	○														
9,40			125	81	0940	○	○														
9,50	M11		125	81	0950	●	●														
9,60			133	87	0960	○	○														



HSSE

TN2

DIN 338

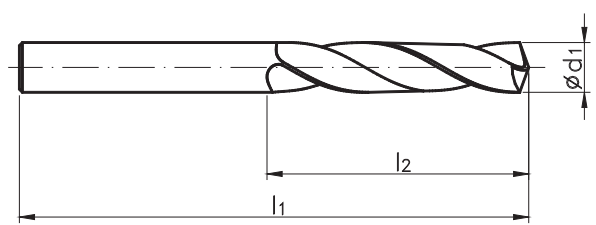

INOX



Rodzaj materiału obrabianego

P	M	K	P	M	K
N	S		N	S	

Wewnętrzne chłodzenie

- -

Rodzaj materiału



HSSE HSSE

Powłoka

- TN2

6

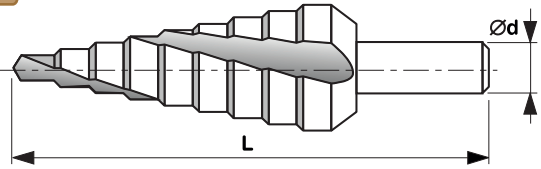
$\varnothing d_1$	M MF	M MF "WGN"	l_1	l_2	Norma	DIN-338	
					Tol.	h8	h8
					INDEX	W2-101811	W2-103811
9,70			133	87	0970	●	○
9,80			133	87	0980	●	○
9,90			133	87	0990	○	○
10,00	M11x1		133	87	1000	●	●
10,10			133	87	1010	●	○
10,20	M12		133	87	1020	●	●
10,30			133	87	1030	●	○
10,40			133	87	1040	○	○
10,50	M12x1,5		133	87	1050	●	●
10,60			133	87	1060	●	○
10,70			142	94	1070	○	○
10,80	M12x1,25		142	94	1080	●	○
10,90			142	94	1090	○	○
11,00	M12x1		142	94	1100	●	●
11,10			142	94	1110	○	○
11,20		M12	142	94	1120	●	○
11,30			142	94	1130	○	○
11,40			142	94	1140	○	○
11,50			142	94	1150	●	○
11,60			142	94	1160	○	○
11,70			142	94	1170	○	○
11,80			142	94	1180	●	○
11,90			151	101	1190	○	○
12,00	M14		151	101	1200	●	●
12,10			151	101	1210	●	○
12,20			151	101	1220	●	○
12,30			151	101	1230	●	○
12,50	M14x1,5		151	101	1250	●	●
12,60			151	101	1260	○	○
12,70			151	101	1270	●	○
12,80	M14x1,25		151	101	1280	●	○
12,90			151	101	1290	○	○
13,00	M14x1	M14	151	101	1300	●	●
13,20			151	101	1320	●	○
13,50			160	108	1350	●	○
13,80			160	108	1380	○	○
14,00	M16;M15x1		160	108	1400	●	●
14,50	M16x1,5		169	114	1450	●	○
15,00	M16x1	M16	169	114	1500	●	●
15,50	M18		178	120	1550	○	○
16,00	M18x2		178	120	1600	●	●

<div style="border: 1px solid black; padding: 2px; display: inline-block; margin-bottom: 5px;">HSS</div> <div style="border: 1px solid black; padding: 2px; display: inline-block; margin-bottom: 5px; background-color: #8B4513; color: white;">TN2</div> 							
Rodzaj materiału obrabianego				-	-	-	-
Wewnętrzne chłodzenie				-	-	-	-
Rodzaj materiału				HSS	HSS	HSS	HSS
Powłoka				-	-	TN2	TN2
Rodzaj rowka				prosty	skrętny R25	prosty	skrętny R25
Ø d	L	Ø D	INDEX	INDEX	INDEX	INDEX	
8	75	4/6/8/10/12/14/16/18/20	W1-641010-0420	W1-648010-0420	W1-646010-0420	W1-649010-0420	
10	100	6/8/10/12/14/16/18/20/22/24/26/28/30	W1-641020-0630	W1-648020-0630	W1-646020-0630	W1-649020-0630	
10	100	6/9/13/16/19/21/23/26/29/32/35/38	W1-641030-0638	W1-648030-0638	W1-646030-0638	W1-649030-0638	
10	100	6/9/11,4/14/17,25/19/21,25/24/26,75/30/33/35,7	W1-642030-0636	W1-645030-0636	-	-	
10	100	6/9/12,5/15,2/18,6/20,4/22,5/26/28,3/30,5/34/37	W1-642040-0637	W1-645040-0637	-	-	



VHM

AT

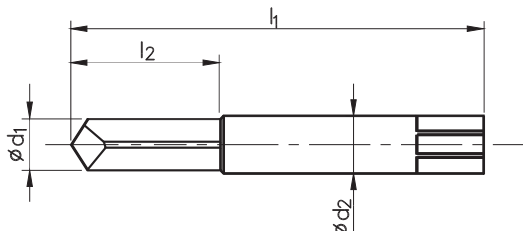

WDG



Rodzaj materiału obrabianego



Wewnętrzne chłodzenie

-

Rodzaj materiału

VHM

Powłoka

AT

Ø d ₁	M	l ₁ ±2	l ₂ ±2	Ø d ₂	Norma	INDEX	W9-900002
					Tol.		
2,5	M3	38	10	3	0250	●	
3,3	M4	46	14	4	0330	●	
4,2	M5	50	19	5	0420	●	
5,0	M6	50	23	6	0500	●	
6,8	M8	60	23	8	0680	●	
8,5	M10	80	25	10	0850	●	
10,2	M12	80	35	12	1020	●	

6

Parametry skrawania dla wiertarek stołowych oraz kolumnowych.
Chłodzenie: na sucho lub mokro (ryzyko nalepień podczas chłodzenia)
Prędkość skrawania: 1000-1500 obr/min

Instrukcja operacji

- Przedmiot obrabiany powinien być zamocowany stabilnie i bezpiecznie.
- Wystającą część gwintownika wyrównać do płaszczyzny przedmiotu obrabianego.
- Wycentrować wiertło kilkakrotnie punktując. W przypadku maszyny sterowanej numerycznie wybrać dla tej operacji mniejszy posuw.
- Gwintownik może być usunięty przy pomocy maszyny sterowanej numerycznie z chłodzeniem (uwaga: ryzyko nalepień), a także przy pomocy wiertarki stołowej lub kolumnowej. Wielokrotne usuwanie wióra jest absolutnie konieczne.
- Usuń pozostałości gwintownika sprężonym powietrzem lub skrobakiem.
- Wykonaj gwint.
- Po wykonaniu gwintu sprawdź poprawność wykonania gwintu przy pomocy sprawdzianu do gwintu.

1 do 5 gwintowników może być usuniętych przy pomocy jednego wiertła do usuwania złamanych gwintowników.

Regeneracja WDG jest nie ekonomiczna.

Z uwagi na sześciokątny chwyt WDG może być mocowane w trój lub cztero – szczękowym uchwycie.

W przypadku poprawnego użytkowania otwór przedmiotu obrabianego nie będzie zniszczony w przypadku każdego rodzaju materiału obrabianego.

posuw		fz		fz		fz		fz		fz	
Vc m/min		φ3,3-6,8		φ6,8-10,2		φ10,2-14,0		φ14,0-15,5		φ15,5-17,5	
od	do	od	do	od	do	od	do	od	do	od	do
10	12	0,040	0,08	0,08	0,110	0,110	0,140	0,140	0,150	0,150	0,170

i

Zestaw do usuwania złamanych wiertel na str. 260

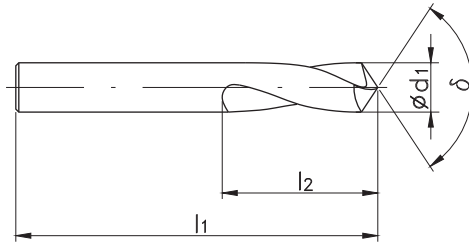

Do nawiercania i fazowania otworów gwintowanych i w jednej operacji
VHM
TN2
HSSE

Rodzaj materiału obrabianego



Wewnętrzne chłodzenie

- - -

Rodzaj materiału

HSSE HSSE VHM

Powłoka

TN2 TN2 -

Kąt wierzchołkowy

90° 120° 142°

Ø d ₁	δ90 / δ120°		δ142°		Norma			
	l ₁	l ₂	l ₁	l ₂	Tol.			
					INDEX	W2-003012	W2-003013	W9-001014
3,0	46	12	45	12,0	0300	●	○	○
4,0	55	12	50	15,0	0400	●	●	●
5,0	62	15	50	18,0	0500	●	●	●
6,0	66	20	50	21,0	0600	●	○	○
8,0	79	25	60	25,0	0800	○	○	○
10,0	89	25	70	27,0	0100	○	○	○
12,0	102	30	70	27,0	0120	●	●	●
14,0	107	34	75	30,0	0140	○	○	○
16,0	115	35	75	30,0	0160	○	○	○

	Rm	Vc[m/min]			Posuw na obrót [mm/obrót]		
		HSSE	HSSE+TN2	VHM	Ø2-Ø6	Ø6-Ø10	Ø10-Ø16
P	Rm<500	35-45	45-55	40-55	0,08-0,15	0,15-0,25	0,25-0,30
	Rm<800	30-40	40-50		0,08-0,15	0,15-0,25	0,25-0,30
	Rm<1000	25-35	35-45		0,05-0,14	0,14-0,20	0,20-0,25
	Rm<1400	8-10	12-15		25-30	0,04-0,12	0,12-0,15
M		10-15	15-20	25-30	0,04-0,12	0,12-0,18	0,18-0,22
K		20-30	30-40	45-50	0,08-0,15	0,15-0,20	0,20-0,25
N		35-80	45-90	55-110	0,08-0,15	0,15-0,20	0,20-0,25
S		5-6	8-10	20-30	0,03-0,06	0,06-0,12	0,12-0,15
H		-	-	10-15	0,04-0,06	0,06-0,10	0,10-0,12

6

Do nawiercania oraz nakiełków A

HSS

HSSE

VHM

DIN 333 A

TN2

AT

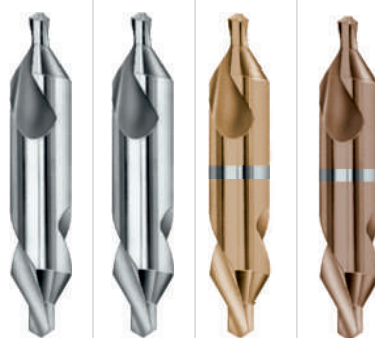
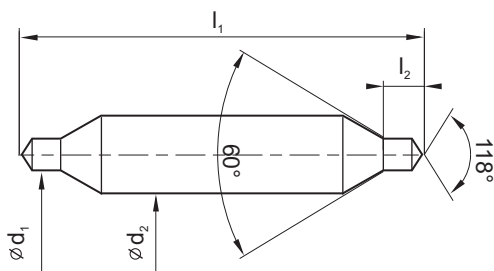

Rodzaj materiału obrabianego

P	M	K	P	M	K	P	M	K	P	M	K
N	S	H	N	S	H	N	S	H	N	S	H

Wewnętrzne chłodzenie

- - - -

Rodzaj materiału

HSS HSSE HSSE VHM

Powłoka

- - TN2 AT

Kąt wierzchołkowy

60° 60° 60° 60°

d ₁	d ₂	l ₁	l ₂ min-max	Norma	DIN-333 A			
					INDEX	W1-011021	W2-011021	W2-013021
0,8	3,15	25	1,0-1,3	0080	●	○	○	○
1,0	3,15	31	1,3-1,7	0100	●	○	○	○
1,25	3,15	31	1,6-2,0	0125	●	○	○	○
1,6	4,0	35	2,0-2,6	0160	●	○	○	○
2,0	5,0	40	2,5-3,1	0200	●	○	○	○
2,5	6,3	45	3,1-3,8	0250	●	○	○	○
3,15	8,0	50	3,9-4,6	0315	●	○	○	○
4,0	10,0	55	5,0-5,9	0400	○	○	○	○
5,0	12,5	63	6,3-7,2	0500	●	○	○	○
6,3	16,0	71	8,0-8,9	0630	●	○	○	○
8,0	20,0	80	10,1-11,1	0800	●	○	○	○
10,0	25,0	100	12,8-13,8	1000	●	○	○	○

		Vc[m/min]				Posuw na obrót [mm/obrót]		
		HSS	HSSE	HSSE+TN2	VHM	ø2-ø6	ø6-ø10	ø10-ø16
P	Rm<500	30-35	35-45	45-55	-	0,08-0,15	0,15-0,25	0,25-0,30
	Rm<800	20-25	30-40	40-50	-	0,08-0,15	0,15-0,25	0,25-0,30
	Rm<1000	15-25	25-35	35-45	25-30	0,05-0,14	0,14-0,20	0,20-0,25
	Rm<1400	-	8-10	12-15	25-30	0,04-0,12	0,12-0,15	0,15-0,18
M		6-10	10-15	15-20	25-40	0,04-0,12	0,12-0,18	0,18-0,22
K		15-20	20-30	30-40	45-50	0,08-0,15	0,15-0,20	0,20-0,25
N		30-80	35-80	45-90	60-150	0,08-0,15	0,15-0,20	0,20-0,25
S		-	5-6	8-10	20-30	0,03-0,06	0,06-0,12	0,12-0,15
H		-	-	-	10-15	0,04-0,05	0,06-0,1	0,1-0,12

6

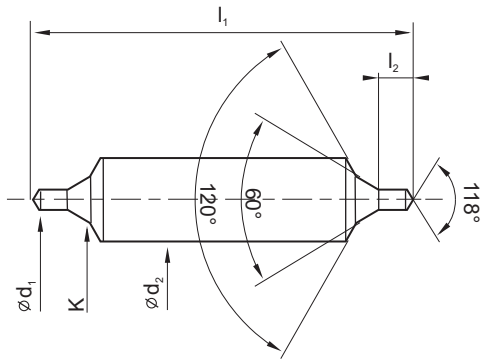
Do nawiercania oraz nakiełków chronionych B
HSS
DIN 333 B

Rodzaj materiału obrabianego



Wewnętrzne chłodzenie

-

Rodzaj materiału

HSS

Powłoka

-

Kąt wierzchołkowy

60°

d ₁	d ₂	K	l ₁	l ₂ min-max	Norma	DIN-333 B				
					INDEX	W1-021021				
1,00	4,0	2,1	35	1,3~1,7	0100	●				
1,25	5,0	2,6	40	1,6~2,0	0125	●				
1,60	6,3	3,3	45	2,0~2,6	0160	●				
2,00	8,0	4,2	50	2,5~3,1	0200	●				
2,50	10,0	5,3	55	3,1~3,8	0250	●				
3,15	11,2	6,7	62	3,9~4,6	0315	●				
4,00	14,0	8,5	69	5,0~5,9	0400	●				
5,00	18,0	10,6	77	6,3~7,2	0500	●				
6,30	20,0	13,2	80	8,0~8,9	0630	●				

6

	Vc (m/min)	Posuw na obrót [mm/obrót]			
		Ø2-Ø6	Ø6-Ø10	Ø10-Ø16	
P	Rm<500	30-35	0,08-0,15	0,15-0,25	0,25-0,30
	Rm<800	20-25	0,08-0,15	0,15-0,25	0,25-0,30
	Rm<1000	15-25	0,05-0,14	0,14-0,20	0,20-0,25
	Rm<1400	-	-	-	-
M	6-10	0,04-0,12	0,12-0,18	0,18-0,22	
K	15-20	0,08-0,15	0,15-0,20	0,20-0,25	
N	30-80	0,08-0,15	0,15-0,20	0,20-0,25	

Zalety nakiełków typu B:

Nakiełek typu B

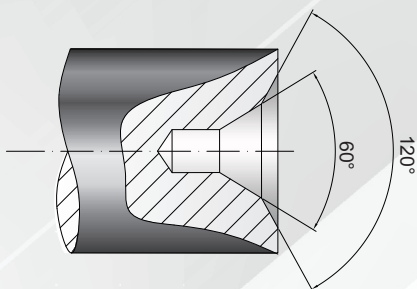

Usuwają grzyby na krawędziach nakiełka

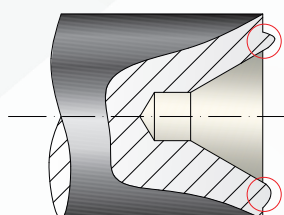

Zaleca się stosowanie nawiertaków typu B przy słabej jakości powierzchni czotowej przedmiotów obrabianych

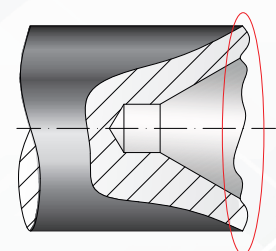
 Przykład zamawiania
 W1-021021-0100
 Nawiertak DIN-333 B 60° 1,0 HSS

- Dostępne z magazynu
- Na zapytanie

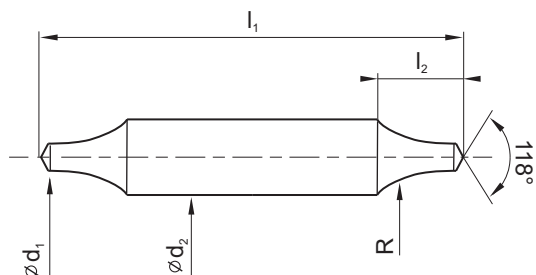
Do nawiercania oraz nakiełków łukowych R
HSS
DIN 333 R

Rodzaj materiału obrabianego



Wewnętrzne chłodzenie

-

Rodzaj materiału

HSS

Powłoka

-

Kąt wierzchołkowy

60°

d ₁	d ₂	R	l ₁	l ₂ min-max	Norma	DIN-333 R
					INDEX	W1-031021
1,00	3,15	2,90	31	3,0~3,3	0100	●
1,25	3,15	3,15	31	3,3~3,6	0125	●
1,00	4,00	3,90	35	3,3~3,6	0100a	●
1,60	4,00	4,00	35	4,2~4,7	0160	●
1,50	5,00	5,00	40	4,5~4,9	0150	●
2,00	5,00	5,00	40	5,0~5,4	0200	●
2,00	6,00	5,80	45	5,4~5,8	0200a	●
2,50	6,30	6,30	45	6,3~6,8	0250	●
2,50	8,00	8,00	50	7,5~8,0	0250a	●
3,00	8,00	8,00	50	8,0~8,5	0300	●
3,15	8,00	8,00	50	8,0~8,5	0315	●
4,00	10,00	10,00	55	10,0~10,6	0400	●
5,00	12,50	12,50	63	12,5~13,1	0500	●

	Vc (m/min)	Posuw na obrót [mm/obrót]			
		ø2-ø6	ø6-ø10	ø10-ø16	
P	Rm<500	30-35	0,08-0,15	0,15-0,25	0,25-0,30
	Rm<800	20-25	0,08-0,15	0,15-0,25	0,25-0,30
	Rm<1000	15-25	0,05-0,14	0,14-0,20	0,20-0,25
	Rm<1400	-	-	-	-
M	6-10	0,04-0,12	0,12-0,18	0,18-0,22	
K	15-20	0,08-0,15	0,15-0,20	0,20-0,25	
N	30-80	0,08-0,15	0,15-0,20	0,20-0,25	

Zalety nakiełków typu R:

Bardzo dobre dopasowanie nakiełków typu R do kłków niezależnie od ich kątów

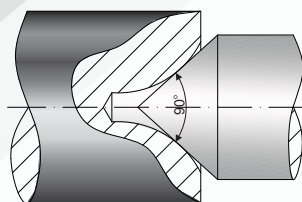
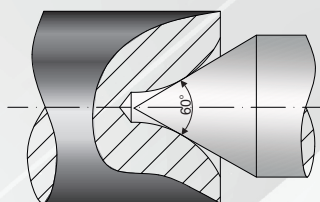

Możliwość zastosowania podczas toczenia stożków (z przesuniętym konikiem)

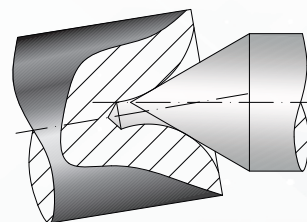

Do nawiercania oraz nakiełków A

HSSE

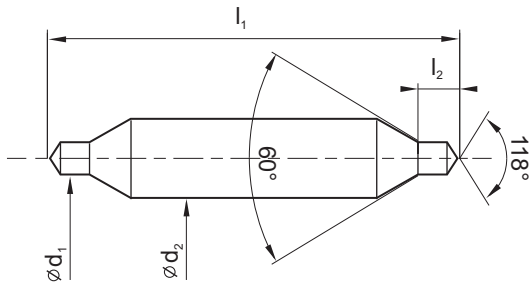
 DIN
333 EL

Rodzaj materiału obrabianego



Wewnętrzne chłodzenie

-

Rodzaj materiału

HSSE

Powłoka

-

Kąt wierzchołkowy

60°

d ₁	d ₂	l ₁	l ₂ min-max	Norma	DIN-333 EL				
				INDEX	W2-041021				
1,50	5,0	100	2,0~2,6	0150	●				
2,00	6,0	100	2,5~3,1	0200	●				
2,50	8,0	120	3,1~3,8	0250	●				
3,15	10,0	120	3,9~4,6	0315	●				
4,00	10,0	120	5,0~5,9	0400	●				
5,00	14,0	120	6,3~7,2	0500	●				

6

	Vc (m/min)	Posuw na obrót [mm/obrót]			
		Ø2-Ø6	Ø6-Ø10	Ø10-Ø16	
P	Rm<500	35-45	0,08-0,15	0,15-0,25	0,25-0,30
	Rm<800	30-40	0,08-0,15	0,15-0,25	0,25-0,30
	Rm<1000	25-35	0,05-0,14	0,14-0,20	0,20-0,25
	Rm<1400	8-10	0,04-0,12	0,12-0,15	0,15-0,18
M	10-15	0,04-0,12	0,12-0,18	0,18-0,22	
K	20-30	0,08-0,15	0,15-0,20	0,20-0,25	
N	35-80	0,08-0,15	0,15-0,20	0,20-0,25	
S	5-6	0,03-0,06	0,06-0,12	0,12-0,15	

Przykład zamawiania

 W2-041021-0150
Nawiertak DIN-333 EL A 60 1,50 HSSE

- Dostępne z magazynu
- Na zapytanie

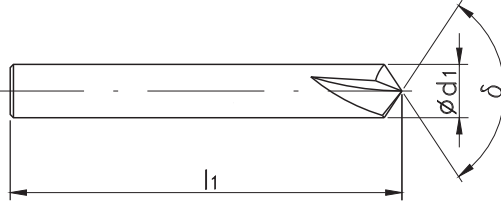
Do fazowania otworów gwintowanych
VHM
AT
**DIN
6537L**

Rodzaj materiału obrabianego



Wewnętrzne chłodzenie

- -

Rodzaj materiału

VHM VHM

Powłoka

AT AT

Kąt wierzchołkowy

60° 90°

$\varnothing d_1$	l_1	z	Norma	DIN-6537L	
			Tol.		
			INDEX	W9-054011	W9-054012
4,0	54	4	0400	●	●
6,0	57	4	0600	●	●
8,0	63	5	0800	●	●
10,0	72	6	1000	●	●
12,0	83	6	1200	●	●
16,0	92	6	1600	●	●
20,0	104	6	2000	○	○

		Vc (m/min)	Posuw na ostrze [mm/ostrze]						
			$\varnothing 4$	$\varnothing 6$	$\varnothing 8$	$\varnothing 10$	$\varnothing 12$	$\varnothing 16$	$\varnothing 20$
P	Rm<500	150-200	0,025-0,030	0,036-0,041	0,052-0,058	0,066-0,073	0,085-0,090	0,100-0,110	0,120-0,130
	Rm<800	130-180	0,023-0,028	0,036-0,039	0,052-0,055	0,065-0,070	0,079-0,085	0,095-0,100	0,110-0,120
	Rm<1000	100-150	0,018-0,025	0,033-0,039	0,047-0,053	0,059-0,065	0,072-0,079	0,088-0,095	0,100-0,110
	Rm<1400	90-120	0,018-0,025	0,028-0,033	0,042-0,047	0,053-0,059	0,063-0,072	0,079-0,088	0,095-0,100
M		70-100	0,020-0,025	0,033-0,039	0,047-0,053	0,059-0,065	0,072-0,079	0,088-0,095	0,100-0,110
K		100-150	0,025-0,028	0,035-0,039	0,050-0,055	0,060-0,065	0,079-0,085	0,095-0,100	0,110-0,120
N		150-300	0,025-0,030	0,035-0,041	0,050-0,058	0,060-0,073	0,079-0,090	0,095-0,110	0,110-0,130
S		40-60	0,010-0,015	0,017-0,024	0,024-0,032	0,030-0,038	0,036-0,046	0,045-0,054	0,057-0,066

6

Do dwustronnego fazowania krawędzi, otworów oraz rowkowania

VHM

TS

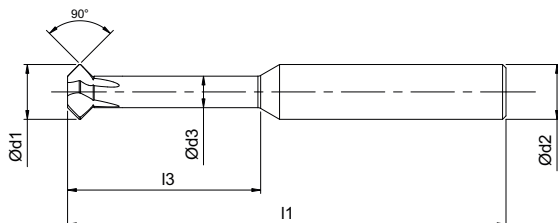

Rodzaj materiału obrabianego



Wewnętrzne chłodzenie

-

Rodzaj materiału

VHM

Powłoka

AT

Kąt wierzchołkowy

90°

d ₁	d ₂	d ₃	l ₁	l ₃	z	INDEX
2,5	3	1,5	39	6,5	3	M9-05G012-0250
3	3	1,8	39	8	3	M9-05G012-0300
3	3	1,8	39	12	3	M9-05G012-0300A
3,5	4	2,1	50	8,5	3	M9-05G012-0350
3,5	4	2,1	50	14	3	M9-05G012-0350A
4	4	2,4	50	10	3	M9-05G012-0400
4	4	2,4	50	16	3	M9-05G012-0400A
5	5	2,8	50	12,5	3	M9-05G012-0500
5	5	2,8	50	20	3	M9-05G012-0500A
6	6	3	57	15	4	M9-05G012-0600
6	6	3	57	24	4	M9-05G012-0600A
6	6	3	100	24	4	M9-05G012-0600B
8	8	4,8	63	20	4	M9-05G012-0800
8	8	4,8	63	32	4	M9-05G012-0800A
8	8	4,8	100	32	4	M9-05G012-0800B

		Vc (m/min)	Posuw na ostrze [mm/ostrze]				
			Ø1-Ø2	Ø3-Ø4	Ø6-Ø8	Ø10-Ø12	Ø16
P	Rm<500	70-90	0,010	0,012	0,015	0,020	0,030
	Rm<800	50-80	0,010	0,012	0,015	0,020	0,030
	Rm<1000	45-60	0,010	0,012	0,013	0,017	0,025
	Rm<1400	40-55	0,010	0,012	0,013	0,017	0,025
M		35-50	0,007	0,010	0,010	0,015	0,020
K		40-60	0,010	0,012	0,013	0,017	0,025
N		60-180	0,012	0,012	0,015	0,020	0,030
S		25-40	0,007	0,010	0,010	0,015	0,020

Przykład zastosowań

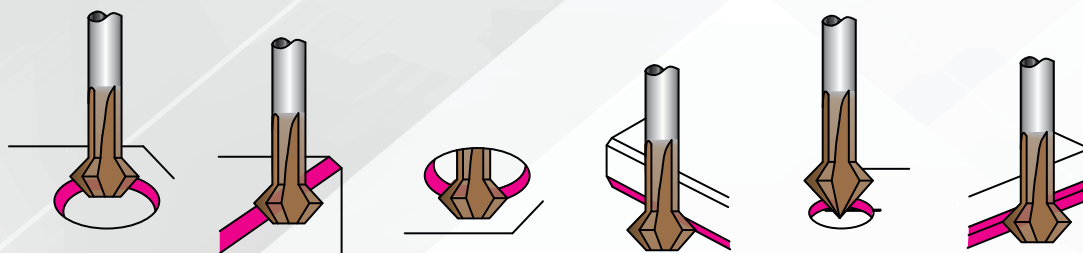

Przykład zamawiania

M9-05G012-0800
Fazownik dwustronny 90° 8x4,8x8x20x63 VHM TS

- Dostępne z magazynu
- Na zapytanie



HSSE DIN 335 C

VHM

TN2

TC

AT

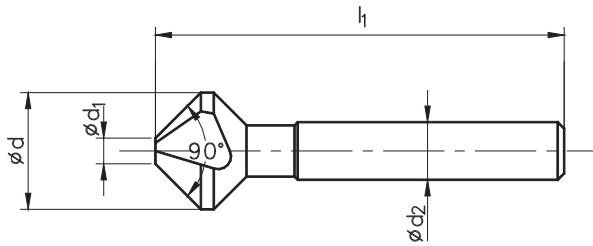

Rodzaj materiału obrabianego



Wewnętrzne chłodzenie

- - - -

Rodzaj materiału

HSSE HSSE HSSE VHM

Powłoka

- TN2 TC AT

Kąt wierzchołkowy

90° 90° 90° 90°

6

ød	ød ₁	ød ₂	l ₁	Norma	DIN-335			
				Tol.				
				INDEX	T2-040010	T2-043010	T2-045110	T9-04V010
6,3	1,50	5	45	0063	●	●	●	●
8,3	2,00	6	50	0083	●	●	●	●
10,4	2,50	6	50	0104	●	●	●	●
12,4	2,80	8	56	0124	●	●	●	●
16,5	3,20	10	60	0165	●	●	●	●
20,5	3,50	10	63	0205	●	●	●	●
25,0	3,80	10	67	0250	●	●	●	●
30,0	4,20	12	71	0300	●	●	●	●

	Rm	Vc (m/min)		Posuw na ostrze [mm/ostrze]							
		HSSE	VHM	ø6,3	ø8,3	ø10,4	ø12,4	ø16,5	ø20,5	ø25	ø30
P	Rm<500	17-22	40-80	0,12	0,13	0,14	0,15	0,17	0,18	0,21	0,24
	Rm<800	10-15	30-60	0,07	0,08	0,09	0,10	0,11	0,13	0,15	0,17
	Rm<1000	8-12	20-40	0,07	0,08	0,09	0,10	0,11	0,13	0,15	0,17
	Rm<1400	-	15-20	0,07	0,08	0,09	0,10	0,11	0,13	0,15	0,17
M		6-10	20-40	0,07	0,08	0,09	0,10	0,11	0,13	0,15	0,17
K		15-25	40-80	0,12	0,13	0,14	0,15	0,17	0,18	0,21	0,24
N		15-45	40-100	0,19	0,20	0,22	0,23	0,26	0,28	0,30	0,36
S		-	10-12	0,04	0,05	0,06	0,06	0,07	0,08	0,09	0,12
H		-	10-12	0,04	0,05	0,06	0,06	0,07	0,08	0,09	0,12



Zestawy pogłębiaczy na str. 260

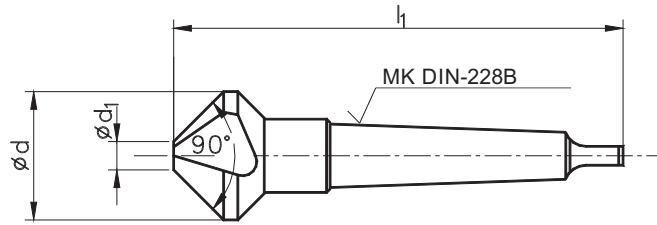

HSS

 DIN
335 D

Rodzaj materiału obrabianego					<input type="checkbox"/> P <input type="checkbox"/> M <input type="checkbox"/> K <input type="checkbox"/> N <input type="checkbox"/> S <input type="checkbox"/> H					
Wewnętrzne chłodzenie					-					
Rodzaj materiału					HSS					
Powłoka					-					
Ø d	Ø d ₁	l ₁	MK DIN-228B	INDEX	T1-040210					
37	4,8	118	2	0370	●					
Ø d	Ø d ₁	l ₁	MK DIN-228B	INDEX	T1-040310					
50	14	150	3	0500	●					
Ø d	Ø d ₁	l ₁	MK DIN-228B	INDEX	T1-040410					
63,0	16,00	180	4	0630	●					
80,0	20,00	180	4	0800	●					

6



PF

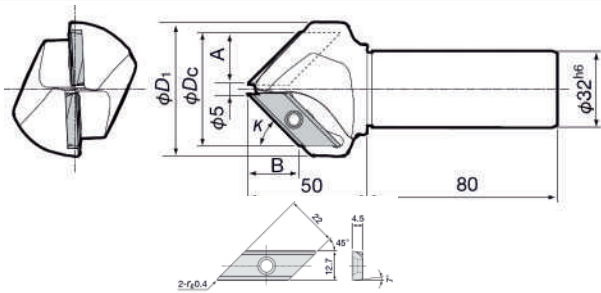

ϕD_1	ϕD_c	κ	A	B	Z	INDEX	
40	34	30°	14,5	25,5	1	T9-100013-0400	●
56	46	45°	20,5	20,5	2	T9-100012-0560	●
72	55	60°	14,5	14,5	2	T9-100011-0720	●

Akcesoria

Nazwa	INDEX
Płytki AH 330	T9-104000-0127
Śruba mocująca	T9-100001-0000
Klucz	T9-100002-0000

Parametry obróbki

Materiał	V(n/min)	posuw f_z (mm/ząb)
Stal węglowa	1000-3000-7000	0,1-0,25
Stal stopowa	1000-3000-7000	0,1-0,2
Stal narzędziowa	1000-3000-7000	0,1-0,2
Stal nierdzewna	1000-3000-7000	0,1-0,25
Żeliwo	1000-3000-7000	0,1-0,25

6

Wielkość skoku narzędzia w osi Z

- Dla fazy 30°

Średnica otworu ϕd (mm)	Wymiar dla fazy C (mm)						
	0,5	1	1,5	2	2,5	3	3,5
5	0,6	1,1	1,6	2,1			
6	0,9	1,4	1,9	2,4			
6,8	1,1	1,6	2,1	2,6			
8	1,4	1,9	2,4	2,9			
8,5	1,6	2,1	2,6	3,1			
10	2,0	2,5	3,0	3,5	4,0	4,5	5,0
10,2	2,1	2,6	3,1	3,6	4,1	4,6	5,1
12	2,6	3,1	3,6	4,1	4,6	5,1	5,6
16	3,7	4,2	4,7	5,2	5,7	6,2	6,7
17,5	4,2	4,7	5,2	5,7	6,2	6,7	7,2
20	4,9	5,4	5,9	6,4	6,9	7,4	7,9
21	5,2	5,7	6,2	6,7	7,2	7,7	8,2
24	6,1	6,6	7,1	7,6	8,1	8,6	9,1
30	7,8	8,3	8,8	9,3	9,8	10,3	10,8
33	8,7	9,2	9,7	10,2	10,7	11,2	11,7
36	9,5	10,0	10,5	11,0	11,5	12,0	12,5
38	10,1	10,6	11,1	11,6	12,1	12,6	13,1
42	11,2	11,7	12,2	12,7	13,2	13,7	14,2
46	12,4	12,9	13,4	13,9	14,4		
48	13,0	13,5	14				
52	14,1						

- Dla fazy 45°

Średnica otworu ϕd (mm)	Wymiar dla fazy C (mm)							
	0,5	1	1,5	2	2,5	3	3,5	4
5	0,8	1,3	1,8	2,3	2,8			
6	1,7	2,2	2,7	3,2	3,7			
6,8	2,4	2,9	3,4	3,9	4,4			
8	3,4	3,9	4,4	4,9	5,4			
8,5	3,8	4,3	4,8	5,3	5,8			
10	5,1	5,6	6,1	6,6	7,1	7,6	8,1	8,6
10,2	5,3	5,8	6,3	6,8	7,3	7,8	8,3	8,8
12	6,9	7,4	7,9	8,4	8,9	9,4	9,9	10,4
16	10,3	10,8	11,3	11,8	12,3	12,8	13,3	13,8
17,5	11,6	12,1	12,6	13,1	13,6	14,1	14,6	15,1
20	13,7	14,2	14,7	15,2	15,7	16,2	16,7	17,2
21	14,6	15,1	15,6	16,1	16,6	17,1	17,6	18,1
24	17,2	17,7	18,2	18,7	19,2	19,7	20,2	20,7
30	22,4	22,9	23,4	23,9	24,4	24,9	25,4	
33	24,9	25,4						

- Dla fazy 60°

Średnica otworu ϕd (mm)	Wymiar dla fazy C (mm)						
	0,5	1	1,5	2	3	4	5
5	0,7	1,2	1,7	2,2	3,2		
6	1,2	1,7	2,2	2,7	3,7		
6,8	1,6	2,1	2,6	3,1	4,1		
8	2,2	2,7	3,2	3,7	4,7		
8,5	2,4	2,9	3,4	3,9	4,9		
10	3,2	3,7	4,2	4,7	5,7	6,7	7,7
10,2	3,3	3,8	4,3	4,8	5,8	6,8	7,8
12	4,2	4,7	5,2	5,7	6,7	7,7	8,7
14	5,2	5,7	6,2	6,7	7,7	8,7	9,7
16	6,2	6,7	7,2	7,7	8,7	9,7	10,7
17,5	6,9	7,4	7,9	8,4	9,4	10,4	11,4
20	8,2	8,7	9,2	9,7	10,7	11,7	12,7
21	8,7	9,2	9,7	10,2	11,2	12,2	13,2
24	10,2	10,7	11,2	11,7	12,7	13,7	14,7
30	13,2	13,7	14,2	14,7	15,7	16,7	17,7
33	14,7	15,2	15,7	16,2	17,2	18,2	19,2
36	16,2	16,7	17,2	17,7	18,7		
42	19,2	19,7	20,2				

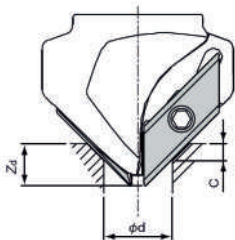

Uwaga:

Jeżeli głębokość otworu fazowanego jest mniejsza niż wartość zagłębienia w osi Z (Z_c), należy zachować szczególną ostrożność dla uniknięcia uszkodzenia czoła narzędzia o dno wywierconego otworu.

Informacje techniczne

- Dla fazowań małych średnic otworów lub pracy wierzchołkiem narzędzia, należy stosować górny zakres prędkości sugerowanych w tabeli.
- Fazując otwory o małej średnicy (poniżej 10mm) w trybie wiercenia nie należy przerywać procesu wycofując narzędzie.
- Jeżeli wymiar fazowanego otworu jest mniejszy niż 10mm lub pracujemy wierzchołkiem narzędzia posuw nie powinien przekraczać wartości 0,15mm/ząb.

									DIN-373							
<div style="border: 1px solid black; padding: 2px; display: inline-block; margin-bottom: 10px;">HSS</div>																
Wykonanie									N		F		M			
Prowadzenie									W otworze pod gwint		W otworze przejściowym dokładnym		W otworze przejściowym średnio dokładnym			
Typ otworu																
Rodzaj materiału									HSS		HSS		HSS			
D z9	d ₁ e8	d h9	l	l ₁	l ₂	L	M	Norma	DIN-373							
								Tol.								
								INDEX	T1-044010							
6,0	2,5	5,0	14	3,0	31,5	71	M3	6025	●							
6,5	2,9	5,0	14	3,5	31,5	71	M3,5	6529	●							
8,0	3,3	5,0	14	4,0	31,5	71	M4	8033	●							
10,0	4,2	8,0	18	5,0	35,5	80	M5	1042	●							
11,0	5,0	8,0	18	6,0	35,5	80	M6	1150	●							
15,0	6,8	12,5	22	8,0	40,0	100	M8	1568	●							
18,0	8,5	12,5	22	10,0	40,0	100	M10	1885	●							
20,0	10,2	12,5	22	12,0	40,0	100	M12	2010	●							
D z9	d ₁ e8	d h9	l	l ₁	l ₂	L	M	Norma	DIN-373							
								Tol.								
								INDEX	T1-045010							
6,0	3,2	5,0	14	3,0	31,5	71	M3	6032	●							
6,5	3,7	5,0	14	3,5	31,5	71	M3,5	6537	●							
8,0	4,3	5,0	14	4,0	31,5	71	M4	8043	●							
10,0	5,3	8,0	18	5,0	35,5	80	M5	1053	●							
11,0	6,4	8,0	18	6,0	35,5	80	M6	1164	●							
15,0	8,4	12,5	22	8,0	40,0	100	M8	1584	●							
18,0	10,5	12,5	22	10,0	40,0	100	M10	1810	●							
20,0	13,0	12,5	22	12,0	40,0	100	M12	2013	●							
D z9	d ₁ e8	d h9	l	l ₁	l ₂	L	M	Norma	DIN-373							
								Tol.								
								INDEX	T1-046010							
6,0	3,4	5,0	14	3,0	31,5	71	M3	6034	●							
6,5	3,9	5,0	14	3,5	31,5	71	M3,5	6539	●							
8,0	4,5	5,0	14	4,0	31,5	71	M4	8045	●							
10,0	5,5	8,0	18	5,0	35,5	80	M5	1055	●							
11,0	6,6	8,0	18	6,0	35,5	80	M6	1166	●							
15,0	9,0	12,5	22	8,0	40,0	100	M8	1590	●							
18,0	11,0	12,5	22	10,0	40,0	100	M10	1811	●							
20,0	14,0	12,5	22	12,0	40,0	100	M12	2014	●							



HSS

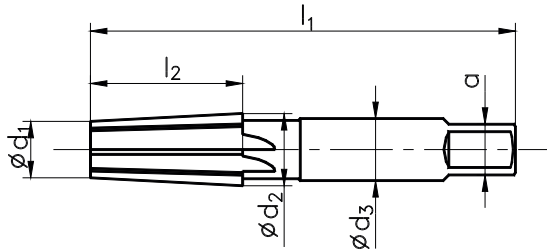

ASME B94,2-1995



Rodzaj materiału

HSS

Wykonanie

C

Ø nom	Ø d ₁	Ø d ₂	Ø d ₃	l ₁	l ₂	a	Norma	INDEX
							Tol.	
1/4	10,30	12,00	14,3	62	27	10,7	0027	•
3/8	13,70	15,40	17,5	65	27	13,5	0029	•
1/2	16,90	19,10	17,5	79	35	13,0	0031	•
3/4	22,25	24,40	23,0	82	35	17,5	0035	•

6



Informacje odnośnie wymiarów otworów pod gwinty stożkowe w części technicznej w katalogu na str. 333



FREZY

TABELA DOBORU

9 - 11

STRONY KATALOGOWE

181 - 214

	MASTERMILL	Wysokowydajne frezy do pracy na centrach obróbczych, przeznaczone do obróbki stali konstrukcyjnych i nierdzewnych o twardości do 45 HRC, żeliw oraz materiałów trudnoobrabialnych na bazie tytanu i niklu.	181 - 183
	X-MILL	Frezy ogólnego przeznaczenia do obróbki materiałów o twardości do 35 HRC.	184 - 195
	ZGR	Frezy VHM ogólnego przeznaczenia, z łamaczem wióra do obróbki zgrubnej.	196 - 197
	HRC	Frezy wykonane z gatunku węglik o nanometrycznej wielkości ziaren ($< 0,2 \mu\text{m}$), przeznaczonego do obróbki materiałów zahartowanych. Posiadają powłokę TS oraz geometrię umożliwiającą obróbkę materiałów o twardości ponad 65 HRC.	198 - 200
	AL	Grupa frezów przeznaczona do wysokowydajnej obróbki metali nieżelaznych takich jak stopy aluminium lub miedzi. Charakteryzują się zoptymalizowaną geometrią, polerowanymi rowkami wiórowymi oraz możliwym wariantem wykonania z powłoką TB.	201 - 212
	MultiCUT	Frez wielofunkcyjny do frezowania kanałków, profilowania, wiercenia, nawiercania, fazowania i grawerowania.	213
	Frez stożkowy 1:16	Frez do przygotowania otworów pod gwinty stożkowe NPT, NPTF, Rc (BSPT)	214

Do obróbki stali i żeluz do twardości 45 HRC, stali nierdzewnych oraz materiałów trudnoobrabialnych

MASTERMILL



Z=4

Wersje bez promienia naroża są chronione fazą $f_1 = 0,2 \times 45^\circ$



λ
42°-45°

VHM

TS

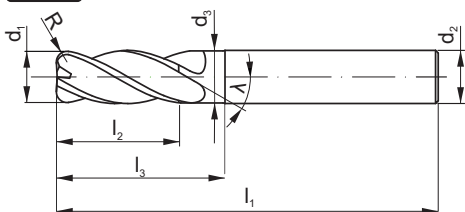

440N

R440N



Rodzaj materiału obrabianego



Chwył



Rodzaj materiału

VHM

VHM

Powłoka

TS

TS

Naroże



d ₁	d ₂ h6	d ₃	l ₁	l ₂	l ₃	Z	R
3	6	2,8	57	8	14	4	0,3
4	6	2,8	57	11	17	4	0,3
5	6	2,8	57	13	19	4	0,3
6	6	5,5	57	13	21	4	0,25
6	6	5,5	57	13	21	4	0,5
6	6	5,5	57	13	21	4	1
8	8	7,5	63	19	27	4	0,5
8	8	7,5	63	19	27	4	1
10	10	9,5	72	22	32	4	0,5
10	10	9,5	72	22	32	4	1
10	10	9,5	72	22	32	4	1,5
12	12	11,5	83	26	38	4	0,5
12	12	11,5	83	26	38	4	1
14	14	13	83	26	38	4	0,5
16	16	15	92	32	44	4	0,5
16	16	15	92	32	44	4	1
16	16	15	92	32	44	4	3
18	18	17	92	32	44	4	0,5
20	20	19	104	38	55	4	0,5
20	20	19	104	38	55	4	1

INDEX	
M9-44GMA0-0030	M9-44GMAD-0030
M9-44GMA0-0040	M9-44GMAD-0040
M9-44GMA0-0050	M9-44GMAD-0050
M9-44GMA0-0060	M9-44GMAC-0060
-	M9-44GMA1-0060
-	M9-44GMA3-0060
M9-44GMA0-0080	M9-44GMA1-0080
-	M9-44GMA3-0080
M9-44GMA0-0100	M9-44GMA1-0100
-	M9-44GMA3-0100
-	M9-44GMA4-0100
M9-44GMA0-0120	M9-44GMA1-0120
-	M9-44GMA3-0120
M9-44GMA0-0140	M9-44GMA1-0140
M9-44GMA0-0160	M9-44GMA1-0160
-	M9-44GMA3-0160
-	M9-44GMA7-0160
M9-44GMA0-0180	M9-44GMA1-0180
M9-44GMA0-0200	M9-44GMA1-0200
-	M9-44GMA3-0200

MASTERMILL

7



ISO	V _c [m/min]	d, [mm]									
		6	8	10	12	14	16	18	20		
P	P1-P4	150-200	0,020	0,030	0,045	0,055	0,060	0,065	0,070	0,080	
	P5-P12	120-160	0,015	0,030	0,040	0,045	0,050	0,055	0,060	0,065	
	P13	70-130	0,010	0,020	0,020	0,035	0,040	0,045	0,050	0,055	
	P14	70-110	0,010	0,020	0,020	0,035	0,040	0,045	0,050	0,055	
M	M1	90-140	0,010	0,020	0,020	0,035	0,040	0,045	0,050	0,055	
	M2-M3	70-100	0,015	0,025	0,040	0,045	0,050	0,055	0,060	0,065	
K	K1-K6	140-200	0,020	0,025	0,040	0,045	0,050	0,055	0,060	0,065	
N	N1-N5	240-280	0,050	0,055	0,065	0,075	0,080	0,085	0,090	0,095	
	N7-N10	260-300	0,050	0,055	0,060	0,070	0,075	0,080	0,085	0,090	
S	S1-S5	30-50	0,020	0,030	0,050	0,055	0,060	0,065	0,070	0,075	
	S6-S8	40-70	0,020	0,035	0,050	0,055	0,060	0,065	0,070	0,075	

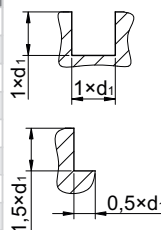

Przykład zamawiania

M9-44GMAC-0060
MASTERMILL R440N 6x5,5x6x13x21x57 R0,25 VHM TS

[R - dotyczy wersji z promieniem naroża]

[Inne wymiary narzędzia dostępne na zapytanie]

Do obróbki stali i żeliw do twardości 45 HRC, stali nierdzewnych oraz materiałów trudnoobrabialnych

MASTERMILL

B440N



VHM

TS

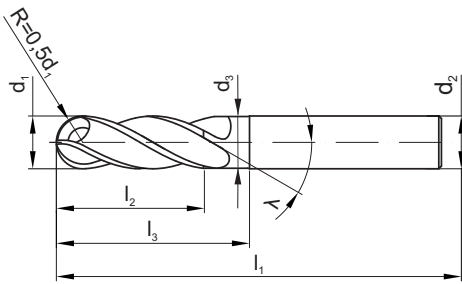

Rodzaj materiału obrabianego



Chwył



Rodzaj materiału

VHM

Powłoka

TS

Naroże



d ₁	d ₂ h6	d ₃	l ₁	l ₂	l ₃	Z	R	INDEX
3	6	-	57	8	-	4	1,5	M9-44GMAX-0030
4	6	-	57	11	-	4	2,0	M9-44GMAX-0040
5	6	-	57	13	-	4	2,5	M9-44GMAX-0050
6	6	5,5	57	13	21	4	3,0	M9-44GMAX-0060
8	8	7,5	63	19	27	4	4,0	M9-44GMAX-0080
10	10	9,5	72	22	32	4	5,0	M9-44GMAX-0100
12	12	11,5	83	26	38	4	6,0	M9-44GMAX-0120
14	14	13	83	26	38	4	7,0	M9-44GMAX-0140
16	16	15	92	32	44	4	8,0	M9-44GMAX-0160
18	18	17	92	32	44	4	9,0	M9-44GMAX-0180
20	20	19	104	38	55	4	10,0	M9-44GMAX-0200

ISO	V _c [m/min]	d, [mm]											
		3	4	5	6	8	10	12	14	16	18	20	
P	P1-P4	150-200	0,025	0,025	0,030	0,040	0,050	0,060	0,070	0,075	0,080	0,085	0,090
	P5-P12	120-160	0,025	0,025	0,030	0,035	0,050	0,055	0,060	0,065	0,070	0,075	0,080
	P13	70-130	0,025	0,025	0,030	0,030	0,045	0,045	0,050	0,055	0,060	0,065	0,070
	P14	70-110	0,015	0,015	0,025	0,030	0,045	0,045	0,050	0,055	0,060	0,065	0,070
M	M1	80-110	0,020	0,020	0,025	0,030	0,045	0,045	0,050	0,055	0,060	0,065	0,070
	M2-M3	60-90	0,020	0,020	0,025	0,040	0,045	0,050	0,055	0,060	0,065	0,070	0,075
K	K1-K5	140-200	0,025	0,025	0,030	0,040	0,060	0,060	0,070	0,075	0,080	0,085	0,090
N	N1-N5	240-280	0,035	0,040	0,050	0,050	0,055	0,065	0,075	0,080	0,085	0,090	0,095
	N7-N10	260-300	0,030	0,035	0,045	0,050	0,055	0,060	0,070	0,075	0,080	0,085	0,090
S	S3-S5	30-50	0,010	0,010	0,010	0,015	0,025	0,025	0,040	0,045	0,050	0,055	0,060
	S6-S8	40-70	0,010	0,010	0,015	0,020	0,030	0,030	0,040	0,045	0,050	0,060	0,065

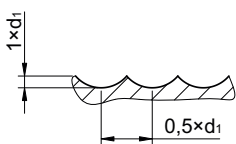

Do obróbki stali i żeliw do twardości 45 HRC, stali nierdzewnych oraz materiałów trudnoobrabialnych					MASTERMILL 645				
Z=6 λ 44°-46° VHM TS 									
Rodzaj materiału obrabianego									
Chwył									
Rodzaj materiału					VHM				
Powłoka					TS				
Naroże									
d ₁	d ₂ h6	l ₁	l ₂	Z	INDEX				
6	6	57	16	6	M9-64GM00-0060				
8	8	63	20	6	M9-64GM00-0080				
10	10	72	25	6	M9-64GM00-0100				
12	12	83	30	6	M9-64GM00-0120				
14	14	83	35	6	M9-64GM00-0140				
16	16	92	40	6	M9-64GM00-0160				
20	20	104	45	6	M9-64GM00-0200				

ISO	V _c [m/min]	d ₁ [mm]							
		6	8	10	12	14	16	20	
		fz [mm]	fz [mm]	fz [mm]	fz [mm]	fz [mm]	fz [mm]	fz [mm]	
P	P1-P4	170-220	0,015	0,020	0,025	0,030	0,035	0,040	0,050
	P5-P12	160-190	0,010	0,020	0,020	0,030	0,030	0,040	0,050
	P13	120-150	0,010	0,010	0,020	0,025	0,030	0,030	0,040
	P14	80-130	0,010	0,010	0,020	0,025	0,030	0,030	0,040
M	M1	90-120	0,010	0,010	0,020	0,025	0,030	0,030	0,040
	M2-M3	80-100	0,015	0,020	0,035	0,040	0,045	0,045	0,055
K	K1-K6	105-135	0,015	0,020	0,025	0,030	0,030	0,035	0,045
N	N1-N5	200-250	0,015	0,020	0,025	0,030	0,035	0,040	0,045
	N7-N10	150-200	0,010	0,010	0,020	0,025	0,030	0,030	0,040
S	S3-S5	40-70	0,015	0,025	0,025	0,040	0,045	0,050	0,060
	S6-S8	60-90	0,020	0,030	0,030	0,040	0,045	0,050	0,065

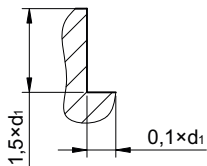

MASTERMILL

7



Do obróbki stali i żeluz o twardości do 35 HRC					X-MILL												
Z=2 λ 30° VHM AT 					230												
Rodzaj materiału obrabianego																	
Chwył																	
Rodzaj materiału					VHM												
Powłoka					AT												
Naroże																	
d ₁	d ₂ h6	l ₁	l ₂	Z	INDEX												
1	4	50	3	2	M9-234X00-0010												
1,5	4	50	4	2	M9-234X00-0015												
2	4	50	6	2	M9-234X00-0020												
2,5	4	50	8	2	M9-234X00-0025												
3	4	50	8	2	M9-234X00-0030												
4	4	50	14	2	M9-234X00-0040												
5	6	50	16	2	M9-234X00-0050												
6	6	50	19	2	M9-234X00-0060												
7	8	58	19	2	M9-234X00-0070												
8	8	58	20	2	M9-234X00-0080												
9	10	72	22	2	M9-234X00-0090												
10	10	72	25	2	M9-234X00-0100												
11	12	73	25	2	M9-234X00-0110												
12	12	73	30	2	M9-234X00-0120												
14	14	83	35	2	M9-234X00-0140												
16	16	92	40	2	M9-234X00-0160												
18	18	100	45	2	M9-234X00-0180												
20	20	104	45	2	M9-234X00-0200												

ISO	V _c [m/min]	d ₁ [mm]															
		1	1,5	2	2,5	3	4	5	6-7	8-9	10-11	12	14	16	18	20	
		fz [mm]	fz [mm]	fz [mm]	fz [mm]	fz [mm]	fz [mm]	fz [mm]	fz [mm]	fz [mm]	fz [mm]	fz [mm]	fz [mm]	fz [mm]	fz [mm]	fz [mm]	
P	P1-P5	70-110	0,002	0,005	0,005	0,010	0,015	0,025	0,035	0,040	0,050	0,070	0,090	0,090	0,110	0,120	0,130
	P6-P12	50-80	0,002	0,004	0,005	0,050	0,010	0,015	0,025	0,030	0,035	0,050	0,060	0,065	0,080	0,085	0,090
	P13-P14	60-90	0,005	0,005	0,007	0,010	0,010	0,010	0,010	0,010	0,015	0,020	0,025	0,030	0,030	0,035	0,035
K	K1-K4	90-110	0,003	0,005	0,010	0,015	0,020	0,030	0,035	0,035	0,040	0,050	0,060	0,065	0,080	0,085	0,090
	K5-K6	80-90	0,003	0,005	0,010	0,015	0,020	0,030	0,035	0,035	0,040	0,050	0,060	0,065	0,080	0,085	0,090
N	N7-N9	150-170	0,005	0,005	0,010	0,010	0,010	0,015	0,015	0,025	0,030	0,035	0,045	0,050	0,055	0,090	0,100

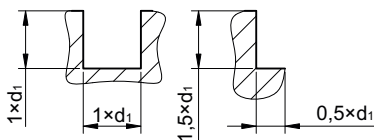

Do obróbki stali i żeliw o twardości do 35 HRC					X-MILL	
					230L	
Rodzaj materiału obrabianego						
Chwył						
Rodzaj materiału					VHM	
Powłoka					AT	
Naroże						
d ₁	d ₂ h6	l ₁	l ₂	Z	INDEX	
6	6	75	15	2	M9-234X20-0060	
6	6	100	15	2	M9-234X20-0060A	
8	8	100	20	2	M9-234X20-0080	
10	10	100	25	2	M9-234X20-0100	
10	10	150	25	2	M9-234X20-0100A	
12	12	100	30	2	M9-234X20-0120	
12	12	150	30	2	M9-234X20-0120A	

ISO	V _c [m/min]	d ₁ [mm]				
		6	8	10	12	
		f _z [mm]	f _z [mm]	f _z [mm]	f _z [mm]	
P	P1-P5	60-90	0,030	0,040	0,055	0,065
	P6-P14	50-80	0,010	0,015	0,020	0,025
K	K1-K4	80-100	0,030	0,030	0,040	0,045
	K5-K6	80-90	0,030	0,030	0,040	0,045
N	N7-N9	150-170	0,020	0,025	0,030	0,040

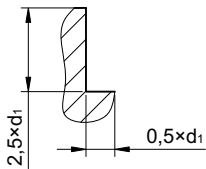

Do obróbki stali i żeliw o twardości do 35 HRC					X-MILL										
					B230										
Rodzaj materiału obrabianego															
Chwyt															
Rodzaj materiału					VHM										
Powłoka					AT										
Naroże															
d ₁	d ₂ h6	l ₁	l ₂	Z	INDEX										
1	4	50	2	2	M9-234X0X-0010										
1,5	4	50	3	2	M9-234X0X-0015										
2	4	50	4	2	M9-234X0X-0020										
2,5	4	50	5	2	M9-234X0X-0025										
3	4	50	6	2	M9-234X0X-0030										
4	4	50	8	2	M9-234X0X-0040										
5	6	50	10	2	M9-234X0X-0050										
6	6	50	12	2	M9-234X0X-0060										
8	8	58	16	2	M9-234X0X-0080										
10	10	72	20	2	M9-234X0X-0100										
12	12	73	24	2	M9-234X0X-0120										
16	16	92	32	2	M9-234X0X-0160										
18	18	100	40	2	M9-234X0X-0180										
20	20	104	40	2	M9-234X0X-0200										

ISO	V _c [m/min]	d ₁ [mm]														
		1	1,5	2	2,5	3	4	5	6	8	10	12	16	18	20	
P	P1-P5	70-110	fz [mm]	fz [mm]	fz [mm]	fz [mm]	fz [mm]	fz [mm]	fz [mm]	fz [mm]	fz [mm]	fz [mm]	fz [mm]	fz [mm]	fz [mm]	
	P6-P12	50-80	0,002	0,005	0,005	0,010	0,015	0,020	0,035	0,040	0,050	0,070	0,085	0,110	0,120	0,130
K	K1-K4	90-110	0,003	0,005	0,010	0,015	0,020	0,030	0,035	0,035	0,035	0,050	0,060	0,070	0,075	0,080
	K5-K6	80-90	0,003	0,005	0,010	0,015	0,020	0,030	0,035	0,035	0,035	0,045	0,045	0,055	0,055	0,070
N	N7-N9	150-170	0,005	0,010	0,015	0,025	0,030	0,035	0,040	0,045	0,045	0,050	0,060	0,070	0,080	0,090

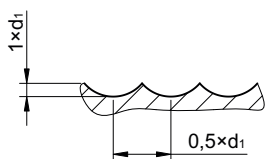

Do obróbki stali i żelw o twardości do 35 HRC					X-MILL			
					B230L			
Rodzaj materiału obrabianego								
Chwył								
Rodzaj materiału					VHM			
Powłoka					AT			
Naroże								
d_1	d_2 h6	l_1	l_2	Z	INDEX			
6	6	75	12	2	M9-234X2X-0060			
6	6	100	12	2	M9-234X2X-0060A			
8	8	100	16	2	M9-234X2X-0080			
10	10	100	20	2	M9-234X2X-0100			
10	10	150	20	2	M9-234X2X-0100A			
12	12	100	24	2	M9-234X2X-0120			
12	12	150	24	2	M9-234X2X-0120A			
16	16	150	32	2	M9-234X2X-0160			

ISO	V_c [m/min]	d_1 [mm]						
		6	8	10	12	14	16	
		f_z [mm]	f_z [mm]	f_z [mm]	f_z [mm]	f_z [mm]	f_z [mm]	
P	P1-P5	70-110	0,040	0,050	0,070	0,085	0,090	0,110
	P6-P12	50-80	0,030	0,035	0,050	0,060	0,065	0,080
K	K1-K4	90-110	0,035	0,035	0,050	0,060	0,065	0,070
	K5-K6	80-90	0,035	0,035	0,045	0,045	0,050	0,055
N	N7-N9	150-170	0,045	0,045	0,050	0,060	0,065	0,070

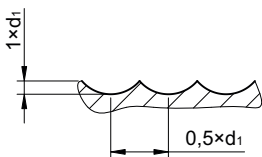

X-MILL

7



Do obróbki stali, stali nierdzewnych i żeliw o twardości do 35 HRC

X-MILL



VHM

AT

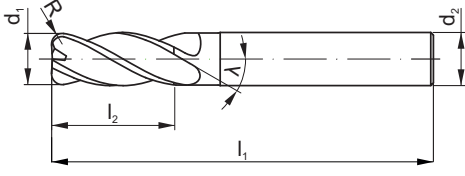

345 345 R345 R345



Rodzaj materiału obrabianego



Chwył



Rodzaj materiału

VHM VHM VHM VHM

Powłoka

AT AT AT AT

Naroże



d ₁	d ₂ h6	l ₁	l ₂	Z	R	INDEX			
3	6	57	8	3	0,3	M9-344X00-0030	M9-344X00-0030-B	M9-344X0D-0030	M9-344X0D-0030-B
4	6	57	11	3	0,3	M9-344X00-0040	M9-344X00-0040-B	M9-344X0D-0040	M9-344X0D-0040-B
5	6	57	13	3	0,3	M9-344X00-0050	M9-344X00-0050-B	M9-344X0D-0050	M9-344X0D-0050-B
6	6	57	13	3	0,5	M9-344X00-0060	M9-344X00-0060-B	M9-344X01-0060	M9-344X01-0060-B
8	8	63	19	3	0,5	M9-344X00-0080	M9-344X00-0080-B	M9-344X01-0080	M9-344X01-0080-B
8	8	63	19	3	1,0	-	-	M9-344X03-0080	M9-344X03-0080-B
8	8	63	19	3	1,5	-	-	M9-344X04-0080	M9-344X04-0080-B
10	10	72	22	3	0,5	M9-344X00-0100	M9-344X00-0100-B	M9-344X01-0100	M9-344X01-0100-B
10	10	72	22	3	2,0	-	-	M9-344X05-0100	M9-344X05-0100-B
12	12	83	26	3	0,7	M9-344X00-0120	M9-344X00-0120-B	M9-344X02-0120	M9-344X02-0120-B
12	12	83	26	3	2,0	-	-	M9-344X05-0120	M9-344X05-0120-B
14	14	83	26	3	0,7	M9-344X00-0140	M9-344X00-0140-B	M9-344X02-0140	M9-344X02-0140-B
16	16	92	32	3	1,0	M9-344X00-0160	M9-344X00-0160-B	M9-344X03-0160	M9-344X03-0160-B

ISO	V _c [m/min]	d ₁ [mm]									
		3	4	5	6	8	10	12	14	16	
		fz [mm]	fz [mm]	fz [mm]	fz [mm]	fz [mm]	fz [mm]	fz [mm]	fz [mm]	fz [mm]	
P	P1-P5	130-160	0,010	0,015	0,025	0,030	0,050	0,060	0,075	0,080	0,085
	P6-P9	80-110	0,010	0,015	0,020	0,025	0,040	0,045	0,055	0,060	0,065
	P10-P12	60-80	0,010	0,015	0,020	0,025	0,040	0,045	0,055	0,060	0,065
	P13	90-140	0,010	0,015	0,020	0,025	0,040	0,045	0,055	0,060	0,065
	P14	90-140	0,005	0,010	0,015	0,020	0,030	0,040	0,045	0,050	0,055
M	M1	90-140	0,010	0,015	0,020	0,025	0,040	0,050	0,060	0,065	0,070
	M2-M3	60-90	0,005	0,010	0,015	0,020	0,030	0,040	0,045	0,050	0,055
K	K1-K6	90-130	0,005	0,010	0,020	0,025	0,040	0,045	0,050	0,055	0,060
N	N1-N5	240-280	0,035	0,040	0,050	0,050	0,055	0,065	0,075	0,080	0,085
	N7-N10	260-300	0,030	0,035	0,045	0,050	0,055	0,060	0,070	0,075	0,080
S	S1,S3	15-25	0,005	0,010	0,015	0,020	0,025	0,035	0,040	0,045	0,050
	S2,S4-S5	10-20	0,005	0,010	0,010	0,015	0,020	0,025	0,030	0,035	0,040
	S6	40-60	0,010	0,015	0,015	0,020	0,025	0,030	0,040	0,045	0,050
	S7-S8	15-20	0,010	0,015	0,015	0,020	0,025	0,030	0,040	0,045	0,050

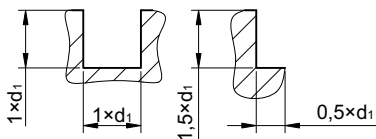

Do obróbki stali, stali nierdzewnych i żeliw o twardości do 35 HRC							X-MILL			
							440S	440S	R440S	R440S
Rodzaj materiału obrabianego										
Chwył										
Rodzaj materiału							VHM	VHM	VHM	VHM
Powłoka							AT	AT	AT	AT
Naroże										
d ₁	d ₂ h6	l ₁	l ₂	Z	R	INDEX				
3	6	54	7	4	0,3	M9-444X10-0030	M9-444X10-0030-B	M9-444X1D-0030	M9-444X1D-0030-B	
4	6	54	8	4	0,3	M9-444X10-0040	M9-444X10-0040-B	M9-444X1D-0040	M9-444X1D-0040-B	
5	6	54	10	4	0,3	M9-444X10-0050	M9-444X10-0050-B	M9-444X1D-0050	M9-444X1D-0050-B	
6	6	54	10	4	0,5	M9-444X10-0060	M9-444X10-0060-B	M9-444X11-0060	M9-444X11-0060-B	
8	8	58	12	4	0,5	M9-444X10-0080	M9-444X10-0080-B	M9-444X11-0080	M9-444X11-0080-B	
8	8	58	12	4	1,0	-	-	M9-444X13-0080	M9-444X13-0080-B	
10	10	66	14	4	0,5	M9-444X10-0100	M9-444X10-0100-B	M9-444X11-0100	M9-444X11-0100-B	
10	10	66	14	4	1,0	-	-	M9-444X13-0100	M9-444X13-0100-B	
10	10	66	14	4	1,5	-	-	M9-444X14-0100	M9-444X14-0100-B	
12	12	73	16	4	0,5	M9-444X10-0120	M9-444X10-0120-B	M9-444X11-0120	M9-444X11-0120-B	
12	12	73	16	4	0,7	-	-	M9-444X12-0120	M9-444X12-0120-B	
12	12	73	16	4	1,0	-	-	M9-444X13-0120	M9-444X13-0120-B	
14	14	75	18	4	0,5	M9-444X10-0140	M9-444X10-0140-B	M9-444X11-0140	M9-444X11-0140-B	
16	16	82	22	4	0,5	M9-444X10-0160	M9-444X10-0160-B	M9-444X11-0160	M9-444X11-0160-B	
16	16	82	22	4	1,0	-	-	M9-444X13-0160	M9-444X13-0160-B	
16	16	82	22	4	2,0	-	-	M9-444X15-0160	M9-444X15-0160-B	
20	20	92	26	4	1,0	M9-444X10-0200	M9-444X10-0200-B	M9-444X13-0200	M9-444X13-0200-B	

ISO	V _c [m/min]	d ₁ [mm]										
		3	4	5	6	8	10	12	14	16	20	
		fz [mm]	fz [mm]	fz [mm]	fz [mm]	fz [mm]	fz [mm]	fz [mm]	fz [mm]	fz [mm]	fz [mm]	
P	P1-P7	130-160	0,005	0,010	0,015	0,020	0,030	0,045	0,055	0,060	0,065	0,080
	P8-P13	60-110	0,005	0,010	0,010	0,015	0,025	0,040	0,045	0,050	0,055	0,065
	P14	90-140	0,005	0,005	0,010	0,015	0,020	0,035	0,040	0,045	0,045	0,055
M	M1	90-140	0,005	0,005	0,010	0,015	0,020	0,035	0,040	0,045	0,045	0,055
	M2	60-90	0,005	0,010	0,010	0,015	0,025	0,040	0,045	0,050	0,055	0,065
	M3	60-80	0,005	0,005	0,010	0,015	0,020	0,035	0,040	0,045	0,045	0,055
K	K1-K6	90-130	0,005	0,010	0,020	0,025	0,030	0,040	0,045	0,050	0,055	0,065
N	N1-N5	240-280	0,035	0,040	0,045	0,050	0,055	0,065	0,075	0,080	0,085	0,095
	N7-N10	260-300	0,030	0,035	0,045	0,050	0,055	0,060	0,070	0,075	0,080	0,090
S	S1-S5	15-25	0,005	0,005	0,010	0,020	0,030	0,050	0,055	0,060	0,065	0,080
	S6-S8	40-60	0,005	0,010	0,015	0,020	0,035	0,050	0,055	0,060	0,065	0,080

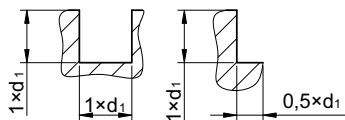

Przykład zamawiania
M9-444X10-0030
X-MILL 440S 3x6x7x54 VHM AT

R - dotyczy wersji z promieniem naroża

Inne wymiary narzędzia dostępne na zapytanie

Do obróbki stali, stali nierdzewnych i żeliwa o twardości do 35 HRC

X-MILL

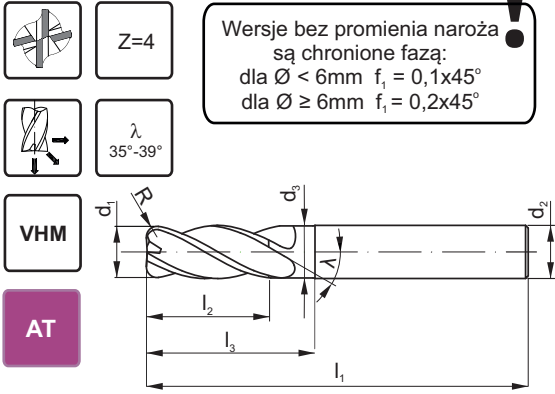

Rodzaj materiału obrabianego



Chwył



Rodzaj materiału

VHM VHM VHM VHM

Powłoka

AT AT AT AT

Naroże



d ₁	d ₂ h6	d ₃	l ₁	l ₂	l ₃	Z	R	INDEX				
1	4	-	50	3	-	4	-	M9-444XA0-0010	-	-	-	-
1,5	4	-	50	4	-	4	-	M9-444XA0-0015	-	-	-	-
2,0	4	-	50	6	-	4	-	M9-444XA0-0020	-	-	-	-
2,5	4	-	50	8	-	4	-	M9-444XA0-0025	-	-	-	-
3	6	-	57	8	-	4	0,3	M9-444XA0-0030	M9-444XA0-0030-B	M9-444XAD-0030	M9-444XAD-0030-B	M9-444XAD-0030-B
4	6	-	57	11	-	4	0,3	M9-444XA0-0040	M9-444XA0-0040-B	M9-444XAD-0040	M9-444XAD-0040-B	M9-444XAD-0040-B
5	6	-	57	13	-	4	0,3	M9-444XA0-0050	M9-444XA0-0050-B	M9-444XAD-0050	M9-444XAD-0050-B	M9-444XAD-0050-B
6	6	5,5	57	13	21	4	0,5	M9-444XA0-0060	M9-444XA0-0060-B	M9-444XA1-0060	M9-444XA1-0060-B	M9-444XA1-0060-B
6	6	5,5	57	13	21	4	1,0	-	-	M9-444XA3-0060	M9-444XA3-0060-B	M9-444XA3-0060-B
8	8	7,5	63	19	27	4	0,5	M9-444XA0-0080	M9-444XA0-0080-B	M9-444XA1-0080	M9-444XA1-0080-B	M9-444XA1-0080-B
8	8	7,5	63	19	27	4	1,0	-	-	M9-444XA3-0080	M9-444XA3-0080-B	M9-444XA3-0080-B
8	8	7,5	63	19	27	4	2,0	-	-	M9-444XA5-0080	M9-444XA5-0080-B	M9-444XA5-0080-B
10	10	9,2	72	22	32	4	0,5	M9-444XA0-0100	M9-444XA0-0100-B	M9-444XA1-0100	M9-444XA1-0100-B	M9-444XA1-0100-B
10	10	9,2	72	22	32	4	1,0	-	-	M9-444XA3-0100	M9-444XA3-0100-B	M9-444XA3-0100-B
10	10	9,2	72	22	32	4	2,0	-	-	M9-444XA5-0100	M9-444XA5-0100-B	M9-444XA5-0100-B

ISO	V _c [m/min]	d ₁ < 3 mm																															
		1		1,5		2		2,5		3		4		5		6		8		10		12		14		16		18		20		25	
		fz [mm]	fz [mm]	fz [mm]	fz [mm]	fz [mm]	fz [mm]	fz [mm]	fz [mm]	fz [mm]	fz [mm]	fz [mm]	fz [mm]	fz [mm]	fz [mm]	fz [mm]	fz [mm]	fz [mm]	fz [mm]	fz [mm]	fz [mm]	fz [mm]	fz [mm]	fz [mm]	fz [mm]	fz [mm]	fz [mm]	fz [mm]	fz [mm]	fz [mm]	fz [mm]	fz [mm]	
P	P1-P5	75	0,004	0,008	0,015	0,015																											
P	P6-P12	60	0,003	0,006	0,010	0,010																											
K	K1-K4	100	0,003	0,006	0,010	0,015																											
K	K5-K6	85	0,003	0,006	0,010	0,015																											
N	N7-N9	170	0,005	0,010	0,015	0,020																											
P	P1-P7	130-160	0,005	0,010	0,015	0,020	0,030	0,045	0,055	0,060	0,065	0,070	0,080	0,095																			
P	P8-P13	60-110	0,005	0,010	0,010	0,015	0,025	0,040	0,045	0,050	0,055	0,060	0,065	0,080																			
P	P14	90-140	0,005	0,005	0,010	0,015	0,020	0,035	0,040	0,045	0,045	0,050	0,055	0,065																			
M	M1	80-120	0,005	0,005	0,010	0,015	0,020	0,035	0,040	0,045	0,045	0,050	0,055	0,065																			
M	M2	60-90	0,005	0,010	0,010	0,015	0,025	0,040	0,045	0,050	0,055	0,060	0,065	0,080																			
M	M3	60-80	0,005	0,005	0,010	0,015	0,020	0,035	0,040	0,045	0,045	0,050	0,055	0,065																			
K	K1-K6	90-130	0,005	0,010	0,020	0,025	0,030	0,040	0,045	0,050	0,055	0,060	0,065	0,080																			
N	N1-N5	240-280	0,035	0,040	0,050	0,050	0,055	0,065	0,075	0,080	0,085	0,090	0,095	0,105																			
N	N7-N10	260-300	0,030	0,035	0,045	0,050	0,055	0,060	0,070	0,075	0,080	0,085	0,090	0,105																			
S	S1-S5	15-25	0,005	0,005	0,010	0,020	0,030	0,050	0,055	0,060	0,065	0,070	0,080	0,095																			
S	S6-S8	40-60	0,005	0,005	0,015	0,020	0,035	0,050	0,055	0,060	0,065	0,070	0,080	0,095																			

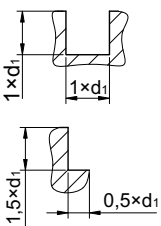

Do obróbki stali, stali nierdzewnych i żeliwa o twardości do 35 HRC								X-MILL					
								440N	440N	R440N	R440N		
Rodzaj materiału obrabianego													
Chwył													
Rodzaj materiału								VHM					
Powłoka								AT					
Naroże													
d ₁	d ₂ h6	d ₃	l ₁	l ₂	l ₃	Z	R	INDEX					
12	12	11	83	26	38	4	0,5	M9-444XA0-0120	M9-444XA0-0120-B	M9-444XA1-0120	M9-444XA1-0120-B		
12	12	11	83	26	38	4	0,7	-	-	M9-444XA2-0120	M9-444XA2-0120-B		
12	12	11	83	26	38	4	1,0	-	-	M9-444XA3-0120	M9-444XA3-0120-B		
12	12	11	83	26	38	4	1,5	-	-	M9-444XA4-0120	M9-444XA4-0120-B		
12	12	11	83	26	38	4	2,0	-	-	M9-444XA5-0120	M9-444XA5-0120-B		
12	12	11	83	26	38	4	3,0	-	-	M9-444XA7-0120	M9-444XA7-0120-B		
14	14	13	83	26	38	4	0,5	M9-444XA0-0140	M9-444XA0-0140-B	M9-444XA1-0140	M9-444XA1-0140-B		
14	14	13	83	26	38	4	0,7	-	-	M9-444XA2-0140	M9-444XA2-0140-B		
14	14	13	83	26	38	4	1,0	-	-	M9-444XA3-0140	M9-444XA3-0140-B		
14	14	13	83	26	38	4	2,0	-	-	M9-444XA5-0140	M9-444XA5-0140-B		
16	16	15	92	32	44	4	0,5	M9-444XA0-0160	M9-444XA0-0160-B	M9-444XA1-0160	M9-444XA1-0160-B		
16	16	15	92	32	44	4	1,0	-	-	M9-444XA3-0160	M9-444XA3-0160-B		
16	16	15	92	32	44	4	2,0	-	-	M9-444XA5-0160	M9-444XA5-0160-B		
16	16	15	92	32	44	4	3,0	-	-	M9-444XA7-0160	M9-444XA7-0160-B		
18	18	17	92	32	44	4	1,0	M9-444XA0-0180	M9-444XA0-0180-B	M9-444XA3-0180	M9-444XA3-0180-B		
20	20	19	104	38	55	4	1,0	M9-444XA0-0200	M9-444XA0-0200-B	M9-444XA3-0200	M9-444XA3-0200-B		
20	20	19	104	45	55	4	1,0	M9-444XA0-0200A	M9-444XA0-0200A-B	M9-444XA3-0200A	M9-444XA3-0200A-B		
20	20	19	104	45	55	4	2,0	-	-	M9-444XA5-0200A	M9-444XA5-0200A-B		
25	25	24	122	55	66	4	1,0	M9-444XA0-0250	M9-444XA0-0250-B	M9-444XA3-0250	M9-444XA3-0250-B		

ISO	Vc [m/min]	d, [mm]												
		3	4	5	6	8	10	12	14	16	18	20	25	
		fz [mm]	fz [mm]	fz [mm]	fz [mm]	fz [mm]	fz [mm]	fz [mm]	fz [mm]	fz [mm]	fz [mm]	fz [mm]	fz [mm]	
P	P1-P7	130-160	0,005	0,010	0,015	0,020	0,030	0,045	0,055	0,060	0,065	0,070	0,080	0,095
	P8-P13	60-110	0,005	0,010	0,010	0,015	0,025	0,040	0,045	0,050	0,055	0,060	0,065	0,080
	P14	90-140	0,005	0,005	0,010	0,015	0,020	0,035	0,040	0,045	0,045	0,050	0,055	0,065
M	M1	80-120	0,005	0,005	0,010	0,015	0,020	0,035	0,040	0,045	0,045	0,050	0,055	0,065
	M2	60-90	0,005	0,010	0,010	0,015	0,025	0,040	0,045	0,050	0,055	0,060	0,065	0,080
	M3	60-80	0,005	0,005	0,010	0,015	0,020	0,035	0,040	0,045	0,045	0,050	0,055	0,065
K	K1-K6	90-130	0,005	0,010	0,020	0,025	0,030	0,040	0,045	0,050	0,055	0,060	0,065	0,080
N	N1-N5	240-280	0,035	0,040	0,050	0,050	0,055	0,065	0,075	0,080	0,085	0,090	0,095	0,105
	N7-N10	260-300	0,030	0,035	0,045	0,050	0,055	0,060	0,070	0,075	0,080	0,085	0,090	0,105
S	S1-S5	15-25	0,005	0,005	0,010	0,020	0,030	0,050	0,055	0,060	0,065	0,070	0,080	0,095
	S6-S8	40-60	0,005	0,005	0,015	0,020	0,035	0,050	0,055	0,060	0,065	0,070	0,080	0,095

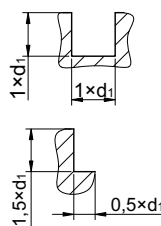

X-MILL

7



Do obróbki stali, stali nierdzewnych i żeliwa o twardości do 35 HRC

X-MILL

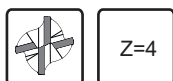

Z=4



λ
35°-39°

Wersje bez promienia naroża są chronione fazą:
dla $\varnothing < 6\text{mm}$ $f_1 = 0,1 \times 45^\circ$
dla $\varnothing \geq 6\text{mm}$ $f_1 = 0,2 \times 45^\circ$

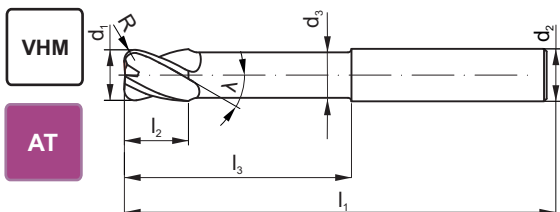

440NL

440NL

R440NL

R440NL



Rodzaj materiału obrabianego



Chwył



Rodzaj materiału

VHM

VHM

VHM

VHM

Powłoka

AT

AT

AT

AT

Naroże



d_1 d_2, h_6 d_3 l_1 l_2 l_3 Z R

INDEX

3	6	2,7	57	7	17	4	0,3	M9-444XG0-0030	M9-444XG0-0030-B	M9-444XGD-0030	M9-444XGD-0030-B
4	6	3,7	63	8	22	4	0,3	M9-444XG0-0040	M9-444XG0-0040-B	M9-444XGD-0040	M9-444XGD-0040-B
5	6	4,7	67	10	27	4	0,3	M9-444XG0-0050	M9-444XG0-0050-B	M9-444XGD-0050	M9-444XGD-0050-B
6	6	5,5	74	10	32	4	0,5	M9-444XG0-0060	M9-444XG0-0060-B	M9-444XG1-0060	M9-444XG1-0060-B
6	6	5,5	74	10	32	4	1,0	-	-	M9-444XG3-0060	M9-444XG3-0060-B
8	8	7,5	90	12	46	4	0,5	M9-444XG0-0080	M9-444XG0-0080-B	M9-444XG1-0080	M9-444XG1-0080-B
8	8	7,5	90	12	46	4	1,0	-	-	M9-444XG3-0080	M9-444XG3-0080-B
10	10	9,2	102	14	55	4	0,5	M9-444XG0-0100	M9-444XG0-0100-B	M9-444XG1-0100	M9-444XG1-0100-B
10	10	9,2	102	14	55	4	1,0	-	-	M9-444XG3-0100	M9-444XG3-0100-B
10	10	9,2	102	14	55	4	2,5	-	-	M9-444XG6-0100	M9-444XG6-0100-B
12	12	11	117	16	64	4	0,5	M9-444XG0-0120	M9-444XG0-0120-B	M9-444XG1-0120	M9-444XG1-0120-B
12	12	11	117	16	64	4	1,0	-	-	M9-444XG3-0120	M9-444XG3-0120-B
16	16	15	141	22	87	4	0,5	M9-444XG0-0160	M9-444XG0-0160-B	M9-444XG1-0160	M9-444XG1-0160-B
16	16	15	141	22	87	4	1,0	-	-	M9-444XG3-0160	M9-444XG3-0160-B
16	16	15	141	22	87	4	2,0	-	-	M9-444XG5-0160	M9-444XG5-0160-B
20	20	19	164	26	110	4	1,0	M9-444XG0-0200	M9-444XG0-0200-B	M9-444XG3-0200	M9-444XG3-0200-B

ISO	V_c [m/min]	d_1 [mm]										
		3	4	5	6	8	10	12	14	16	20	
P	P1-P7	130-160	0,005	0,010	0,015	0,020	0,030	0,045	0,055	0,060	0,065	0,080
	P8-P13	60-110	0,005	0,010	0,010	0,015	0,025	0,040	0,045	0,050	0,055	0,065
	P14	90-140	0,005	0,005	0,010	0,015	0,020	0,035	0,040	0,045	0,045	0,055
M	M1	75-90	0,005	0,005	0,010	0,015	0,020	0,035	0,040	0,045	0,045	0,055
	M2	60-70	0,005	0,010	0,010	0,015	0,025	0,040	0,045	0,050	0,055	0,065
	M3	45-55	0,005	0,005	0,010	0,015	0,025	0,035	0,040	0,045	0,045	0,055
K	K1-K6	90-130	0,005	0,010	0,020	0,025	0,030	0,040	0,045	0,050	0,055	0,065
N	N1-N5	240-280	0,035	0,040	0,050	0,050	0,055	0,065	0,075	0,080	0,085	0,095
	N7-N10	260-300	0,030	0,035	0,045	0,050	0,055	0,060	0,070	0,075	0,080	0,090
S	S1-S5	15-25	0,005	0,010	0,015	0,020	0,030	0,050	0,055	0,060	0,065	0,080
	S6-S8	40-60	0,005	0,010	0,015	0,020	0,035	0,050	0,055	0,060	0,650	0,075

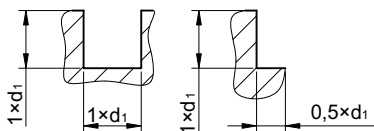

Do obróbki stali i żeliwa o twardości do 35 HRC							X-MILL					
							430L	430L	R430L			
Rodzaj materiału obrabianego												
Chwył												
Rodzaj materiału							VHM	VHM	VHM			
Powłoka							AT	AT	AT			
Naroże												
d ₁	d ₂ h6	l ₁	l ₂	Z	R	INDEX						
2	4	50	15	4	-	M9-434X20-0020	-	-				
3	4	50	20	4	0,3	M9-434X20-0030	-	M9-434X2D-0030				
4	4	75	25	4	0,3	M9-434X20-0040	-	M9-434X2D-0040				
5	6	75	30	4	0,3	M9-434X20-0050	M9-434X20-0050-B	M9-434X2D-0050				
6	6	75	30	4	0,5	M9-434X20-0060	M9-434X20-0060-B	M9-434X21-0060				
8	8	100	40	4	0,5	M9-434X20-0080	M9-434X20-0080-B	M9-434X21-0080				
10	10	100	40	4	0,5	M9-434X20-0100	M9-434X20-0100-B	M9-434X21-0100				
12	12	100	45	4	0,7	M9-434X20-0120	M9-434X20-0120-B	M9-434X22-0120				
16	16	150	60	4	1,0	M9-434X20-0160	M9-434X20-0160-B	M9-434X23-0160				
20	20	150	60	4	1,0	M9-434X20-0200	M9-434X20-0200-B	M9-434X23-0200				
ISO	V _c [m/min]	d, [mm]										
		2	3	4	5	6	8	10	12	16	20	
P	P1-P5	50-65	0,010	0,015	0,020	0,030	0,040	0,060	0,075	0,085	0,100	0,110
	P6-P12	40-50	0,005	0,010	0,010	0,100	0,010	0,015	0,020	0,020	0,025	0,030
K	K1-K4	60-80	0,005	0,010	0,010	0,015	0,030	0,040	0,050	0,055	0,060	
	K5-K6	50-70	0,005	0,010	0,010	0,015	0,030	0,040	0,050	0,055	0,060	
N	N7-N9	90-140	0,015	0,025	0,030	0,030	0,035	0,040	0,050	0,060	0,075	0,090

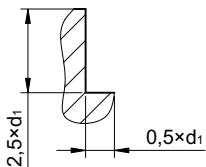

Do obróbki stali, stali nierdzewnych i żeliwa o twardości do 35 HRC

X-MILL

B440

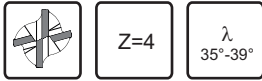

VHM

AT

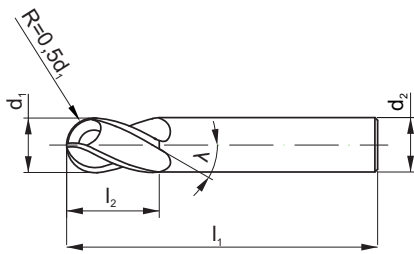

Rodzaj materiału obrabianego



Chwył



Rodzaj materiału

VHM

Powłoka

AT

Naroże



d ₁	d ₂ h6	l ₁	l ₂	Z	R	INDEX
3	6	54	7	4	1,5	M9-444X1X-0030
4	6	54	8	4	2,0	M9-444X1X-0040
5	6	54	10	4	2,5	M9-444X1X-0050
6	6	54	10	4	3,0	M9-444X1X-0060
8	8	58	12	4	4,0	M9-444X1X-0080
10	10	66	14	4	5,0	M9-444X1X-0100
12	12	73	16	4	6,0	M9-444X1X-0120
14	14	75	18	4	7,0	M9-444X1X-0140
16	16	82	22	4	8,0	M9-444X1X-0160
18	18	84	24	4	9,0	M9-444X1X-0180
20	20	92	26	4	10,0	M9-444X1X-0200

ISO	V _c [m/min]	d ₁ [mm]											
		3	4	5	6	8	10	12	14	16	18	20	
P	P1-P13	80-130	0,025	0,025	0,030	0,040	0,060	0,060	0,070	0,075	0,080	0,085	0,090
	P14	60-70	0,015	0,015	0,025	0,030	0,040	0,045	0,050	0,055	0,060	0,065	0,070
M	M1-M2	60-85	0,020	0,020	0,025	0,040	0,045	0,050	0,055	0,060	0,065	0,070	0,075
K	K1-K6	80-130	0,025	0,025	0,030	0,040	0,060	0,060	0,070	0,075	0,080	0,085	0,090
N	N1-N5	240-280	0,035	0,040	0,050	0,050	0,055	0,065	0,075	0,080	0,085	0,090	0,095
	N7-N10	260-300	0,030	0,035	0,045	0,050	0,055	0,060	0,070	0,075	0,080	0,085	0,090
S	S1-S5	20-30	0,010	0,010	0,010	0,015	0,025	0,025	0,040	0,045	0,050	0,055	0,060
	S6-S8	40-55	0,010	0,010	0,015	0,020	0,030	0,030	0,040	0,045	0,050	0,060	0,065

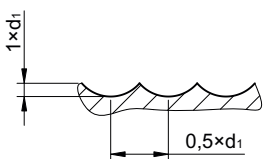

Do obróbki stali, stali nierdzewnych i żeliwa o twardości do 35 HRC						X-MILL			
						540	540	R540	R540
Rodzaj materiału obrabianego									
Chwył									
Rodzaj materiału						VHM			
Powłoka						AT			
Naroże									
d ₁	d ₂ h6	l ₁	l ₂	Z	R	INDEX			
6	6	57	13	5	0,5	M9-544X00-0060	M9-544X00-0060-B	M9-544X01-0060	M9-544X01-0060-B
8	8	63	19	5	0,5	M9-544X00-0080	M9-544X00-0080-B	M9-544X01-0080	M9-544X01-0080-B
8	8	63	19	5	1,0	-	-	M9-544X03-0080	M9-544X03-0080-B
8	8	63	19	5	1,5	-	-	M9-544X04-0080	M9-544X04-0080-B
8	8	63	19	5	2,0	-	-	M9-544X05-0080	M9-544X05-0080-B
10	10	72	22	5	0,5	M9-544X00-0100	M9-544X00-0100-B	M9-544X01-0100	M9-544X01-0100-B
10	10	72	22	5	2,5	-	-	M9-544X06-0100	M9-544X06-0100-B
12	12	83	26	5	0,5	M9-544X00-0120	M9-544X00-0120-B	M9-544X01-0120	M9-544X01-0120-B
12	12	83	26	5	0,7	-	-	M9-544X02-0120	M9-544X02-0120-B
12	12	83	26	5	1,0	-	-	M9-544X03-0120	M9-544X03-0120-B
14	14	83	26	5	0,5	M9-544X00-0140	M9-544X00-0140-B	M9-544X01-0140	M9-544X01-0140-B
16	16	92	32	5	0,5	M9-544X00-0160	M9-544X00-0160-B	M9-544X01-0160	M9-544X01-0160-B
16	16	92	32	5	1,0	-	-	M9-544X03-0160	M9-544X03-0160-B
16	16	92	32	5	2,0	-	-	M9-544X05-0160	M9-544X05-0160-B
18	18	92	32	5	1,0	M9-544X00-0180	M9-544X00-0180-B	M9-544X03-0180	M9-544X03-0180-B
20	20	104	38	5	1,0	M9-544X00-0200	M9-544X00-0200-B	M9-544X03-0200	M9-544X03-0200-B

ISO	V _c [m/min]	d, [mm]									
		6	8	10	12	14	16	18	20		
P	P1-P13	130-150	0,035	0,040	0,050	0,065	0,070	0,075	0,080	0,090	
	P14	90-100	0,030	0,035	0,040	0,045	0,065	0,070	0,070	0,075	
M	M1-M2	70-100	0,030	0,035	0,040	0,045	0,065	0,070	0,070	0,075	
K	K1-K6	110-140	0,035	0,040	0,050	0,065	0,070	0,075	0,075	0,090	
N	N1-N5	240-280	0,050	0,055	0,065	0,075	0,080	0,085	0,085	0,095	
	N7-N10	260-300	0,050	0,055	0,060	0,070	0,075	0,080	0,085	0,090	
S	S1-S5	20-30	0,015	0,020	0,025	0,035	0,045	0,050	0,050	0,060	
	S6-S8	40-65	0,030	0,035	0,040	0,050	0,055	0,065	0,065	0,075	

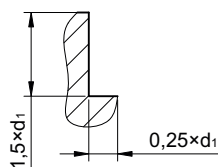

X-MILL

7



Przykład zamawiania
M9-544X00-0060
X-MILL 540 6x6x13x57 VHM AT

[R - dotyczy wersji z promieniem naroża] [Inne wymiary narzędzia dostępne na zapytanie]

Do obróbki zgrubnej stali, żeliw, materiałów trudnoobrabialnych i metali nieżelaznych					ZGR	
					420	420
<div style="display: flex; flex-wrap: wrap;"> <div style="border: 1px solid black; padding: 2px; margin: 2px;">Typ HR</div> <div style="border: 1px solid black; padding: 2px; margin: 2px;">Z=4</div> <div style="border: 1px solid black; padding: 2px; margin: 2px;"></div> <div style="border: 1px solid black; padding: 2px; margin: 2px;">λ 20°</div> <div style="border: 1px solid black; padding: 2px; margin: 2px;">VHM</div> <div style="border: 1px solid black; padding: 2px; margin: 2px;">AT</div> </div>						
Rodzaj materiału obrabianego						
Chwył						
Rodzaj materiału					VHM	
Powłoka					AT	
Naroże						
d ₁	d ₂ h6	l ₁	l ₂	Z	INDEX	
6	6	57	16	4	M9-424A00-0060	M9-424A00-0060-B
7	8	63	16	4	M9-424A00-0070	M9-424A00-0070-B
8	8	63	16	4	M9-424A00-0080	M9-424A00-0080-B
9	10	72	19	4	M9-424A00-0090	M9-424A00-0090-B
10	10	72	22	4	M9-424A00-0100	M9-424A00-0100-B
12	12	83	26	4	M9-424A00-0120	M9-424A00-0120-B
14	14	83	26	4	M9-424A00-0140	M9-424A00-0140-B
16	16	92	32	4	M9-424A00-0160	M9-424A00-0160-B
18	18	92	32	4	M9-424A00-0180	M9-424A00-0180-B
20	20	104	38	4	M9-424A00-0200	M9-424A00-0200-B

ISO	V _c [m/min]	d ₁ [mm]								
		6	8	10	12	14	16	18	20	
P	P1-P8	100-140	0,030	0,035	0,035	0,045	0,050	0,055	0,060	0,070
	P9-P11	100-120	0,025	0,030	0,030	0,035	0,040	0,045	0,045	0,050
	P13-P14	50-65	0,015	0,020	0,020	0,025	0,030	0,035	0,035	0,040
M	M1-M3	40-60	0,015	0,020	0,020	0,025	0,030	0,035	0,035	0,040
K	K1-K2	110-160	0,030	0,035	0,045	0,050	0,055	0,056	0,060	0,070
	K3-K6	80-110	0,020	0,020	0,035	0,035	0,040	0,040	0,045	0,050
H	H1,H2,H4	50-90	0,020	0,020	0,035	0,030	0,035	0,035	0,040	0,040

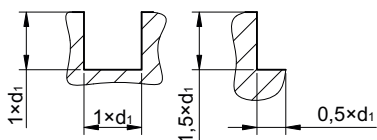

Do obróbki zgrubnej stali, żeliw, materiałów trudnoobrabialnych i metali nieżelaznych								ZGR 440N / 540N / 640N	
Rodzaj materiału obrabianego									
Chwył								VHM	
Rodzaj materiału								TS	
Powłoka									
Naroże									
d_1	d_2, h_6	d_3	l_1	l_2	l_3	Z	F	INDEX	
6	6	5,5	57	13	21	4	0,3	M9-44GAA0-0060	
8	8	7,5	63	19	27	4	0,4	M9-44GAA0-0080	
10	10	9,5	72	22	32	5	0,5	M9-54GAA0-0100	
12	12	11,5	83	26	38	5	0,6	M9-54GAA0-0120	
16	16	15	92	32	44	6	0,8	M9-64GAA0-0160	

ISO	V_c [m/min]	d_1 [mm]					
		6	8	10	12	16	
		f_z [mm]	f_z [mm]	f_z [mm]	f_z [mm]	f_z [mm]	
P	P1-P8	130-150	0,03	0,035	0,035	0,45	0,55
	P9-P11	90-120	0,025	0,03	0,03	0,035	0,045
	P13-P14	60-80	0,015	0,02	0,02	0,025	0,035
M	M1-M3	50-70	0,015	0,02	0,2	0,025	0,035
K	K1-K2	110-160	0,03	0,035	0,045	0,05	0,055
	K3-K6	80-110	0,02	0,02	0,035	0,035	0,04
H	H1,H2,H4	40-80	0,02	0,02	0,03	0,035	0,035

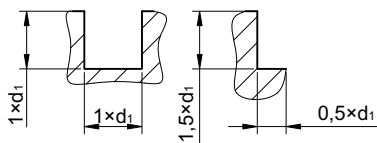

Do obróbki z wysokimi posuwami

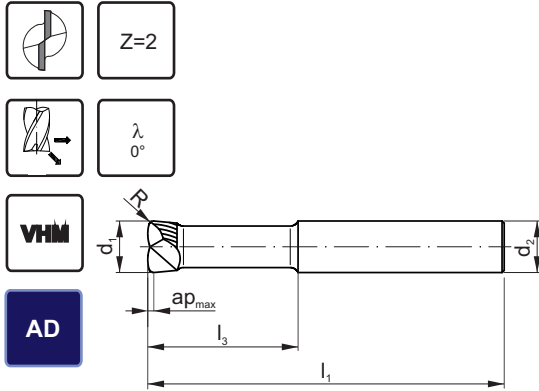

HRC

HFM 200



Rodzaj materiału obrabianego



Chwył



Rodzaj materiału

VHM

Powłoka

AD

Naroże



d_1	d_2 h6	l_1	$a_{p_{max}}$	l_3	Z	R	INDEX
6	6	57	0,30	20	2	0,6	M9-20E9A0-0060
8	8	63	0,35	20	2	0,8	M9-20E9A0-0080
10	10	72	0,40	30	2	1,0	M9-20E9A0-0100
12	12	83	0,70	35	2	1,2	M9-20E9A0-0120
16	16	92	0,80	50	2	1,6	M9-20E9A0-0160

ISO	V_c [m/min]	a_e [mm]	d_1 [mm]					
			6	8	10	12	16	
			f_z [mm]	f_z [mm]	f_z [mm]	f_z [mm]	f_z [mm]	
P	P1-P5	300-350	0,4 - 0,6xD	0,4	0,5	0,6	0,8	1,2
	P6-P14	200-250	0,4 - 0,6xD	0,3	0,4	0,5	0,6	1,0
K	K1-K3	400-450	0,4 - 0,6xD	0,4	0,5	0,6	0,8	1,2
	K4-K6	300-350	0,4 - 0,6xD	0,3	0,4	0,5	0,6	1,0
H	H1-H4	70-120	0,2 - 0,4xD	0,3	0,4	0,5	0,6	1,0



Materiały z grupy H obrabiać wyłącznie „na sucho”. Szczegóły na str. 325 informacji technicznych.

Do obróbki zahartowanych materiałów

HRC
B415N

Rodzaj materiału obrabianego: P, M, K, N, S, H

Chwył: [Symbol]

Rodzaj materiału: VHM

Powłoka: TS

Naroże: [Symbol]

d ₁	d ₂ h6	d ₃	l ₁	l ₂	l ₃	Z	R	INDEX
3	6	2,9	57	7	21	4	1,5	M9-41G9AX-0030
4	6	3,9	57	8	21	4	2,0	M9-41G9AX-0040
5	6	4,9	57	10	21	4	2,5	M9-41G9AX-0050
6	6	5,9	57	10	21	4	3,0	M9-41G9AX-0060
8	8	7,8	63	12	23	4	4,0	M9-41G9AX-0080
10	10	9,8	72	14	27	4	5,0	M9-41G9AX-0100
12	12	11,8	75	16	30	4	6,0	M9-41G9AX-0120
16	16	15,8	92	22	44	4	8,0	M9-41G9AX-0160

ISO	Vc [m/min]	d, [mm]								
		3	4	5	6	8	10	12	16	
H	H1	180-220	0,040	0,055	0,070	0,085	0,100	0,120	0,160	0,220
	H2, H4	140-180	0,030	0,035	0,055	0,065	0,080	0,100	0,150	0,175
	H3	115-160	0,025	0,035	0,045	0,055	0,065	0,085	0,100	0,150

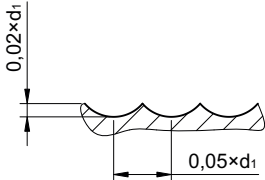

i Materiały z grupy H obrabiać wyłącznie „na sucho”. Szczegóły na str. 325 informacji technicznych.



Do obróbki zahartowanych materiałów

HRC

R645



Z=6



λ
45°

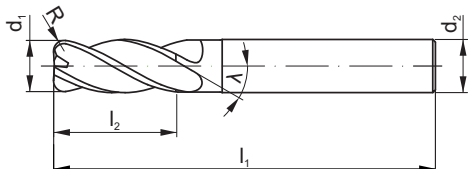

Rodzaj materiału obrabianego



Chwył



Rodzaj materiału

VHM

Powłoka

TS

Naroże



d_1	d_2h6	l_1	l_2	Z	R	INDEX
6	6	57	13	6	0,5	M9-64G901-0060
8	8	63	19	6	0,5	M9-64G901-0080
10	10	72	22	6	1,0	M9-64G903-0100
12	12	75	26	6	1,0	M9-64G903-0120
16	16	92	32	6	1,5	M9-64G904-0160

ISO	V_c [m/min]	d_1 [mm]					
		6	8	10	12	16	
H	H1	80-140	0,035	0,050	0,060	0,070	0,085
	H2-H4	50-80	0,025	0,035	0,045	0,050	0,065

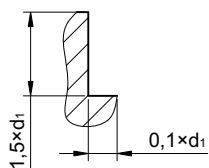

Materiały z grupy H obrabiać wyłącznie „na sucho”. Szczegóły na str. 325 informacji technicznych.

Do obróbki aluminium, jego stopów oraz metali nieżelaznych					AL									
					130									
Rodzaj materiału obrabianego					<table border="1"> <tr> <td>P</td><td>M</td><td>K</td> </tr> <tr> <td>N</td><td>S</td><td>H</td> </tr> </table>				P	M	K	N	S	H
P	M	K												
N	S	H												
Chwył														
Rodzaj materiału					VHM									
Powłoka					-									
Naroże														
d_1	d_2, h_6	l_1	l_2	Z	INDEX									
3	6	57	12	1	M9-131700-0030									
4	6	57	12	1	M9-131700-0040									
5	6	57	14	1	M9-131700-0050									
6	6	57	16	1	M9-131700-0060									
8	8	63	20	1	M9-131700-0080									
10	10	72	22	1	M9-131700-0100									
ISO	V_c [m/min]	d_1 [mm]												
		3	4	5	6	8	10							
N	N1-N2	250-400	fz [mm]	fz [mm]	fz [mm]	fz [mm]	fz [mm]	fz [mm]						
	N3-N5	290-440	0,010	0,015	0,020	0,025	0,030	0,035						
	N7-N9	210-360	0,010	0,015	0,020	0,025	0,030	0,035						
			0,005	0,010	0,015	0,020	0,025	0,030						

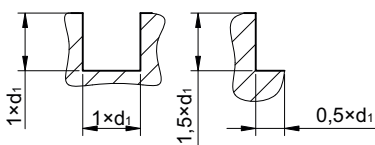

Do obróbki aluminium, jego stopów oraz metali nieżelaznych						AL					
						245	245	R245	R245		
Rodzaj materiału obrabianego											
Chwył											
Rodzaj materiału						VHM					
Powłoka						-					
Naroże											
d ₁	d ₂	l ₁	l ₂	Z	R	INDEX					
3	3	39	12	2	0,3	M9-241700-0030	-	M9-24170D-0030	-		
4	4	51	12	2	0,3	M9-241700-0040	-	M9-24170D-0040	-		
5	5	51	14	2	0,3	M9-241700-0050	-	M9-24170D-0050	-		
6	6	57	16	2	0,5	M9-241700-0060	M9-241700-0060-B	M9-241701-0060	M9-241701-0060-B		
6	6	57	16	2	1	-	-	M9-241703-0060	M9-241703-0060-B		
8	8	63	20	2	0,5	M9-241700-0080	M9-241700-0080-B	M9-241701-0080	M9-241701-0080-B		
8	8	63	20	2	1	-	-	M9-241703-0080	M9-241703-0080-B		
10	10	72	22	2	0,5	M9-241700-0100	M9-241700-0100-B	M9-241701-0100	M9-241701-0100-B		
12	12	83	32	2	0,5	M9-241700-0120	M9-241700-0120-B	M9-241701-0120	M9-241701-0120-B		
14	14	83	32	2	0,5	M9-241700-0140	M9-241700-0140-B	M9-241701-0140	M9-241701-0140-B		
16	16	92	36	2	0,5	M9-241700-0160	M9-241700-0160-B	M9-241701-0160	M9-241701-0160-B		
18	18	92	45	2	1	M9-241700-0180	M9-241700-0180-B	M9-241703-0180	M9-241703-0180-B		
20	20	104	50	2	1	M9-241700-0200	M9-241700-0200-B	M9-241703-0200	M9-241703-0200-B		

ISO	V _c [m/min]	d ₁ [mm]											
		3	4	5	6	8	10	12	14	16	18	20	
N	N1-N2	180-270	0,035	0,045	0,050	0,060	0,090	0,110	0,135	0,145	0,155	0,180	0,200
	N3-N4	380-480	0,045	0,055	0,065	0,080	0,150	0,160	0,170	0,200	0,230	0,250	0,270
	N7-N9	180-270	0,010	0,015	0,020	0,025	0,030	0,035	0,050	0,050	0,055	0,090	0,100

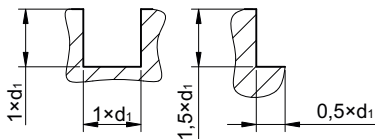

Do obróbki aluminium, jego stopów oraz metali nieżelaznych							AL			
							245	245	R245	R245
Rodzaj materiału obrabianego										
Chwył										
Rodzaj materiału							VHM			
Powłoka							TB			
Naroże										
d ₁	d ₂	l ₁	l ₂	Z	R	INDEX				
3	3	39	12	2	0,3	M9-24B700-0030	-	M9-24B70D-0030	-	
4	4	51	12	2	0,3	M9-24B700-0040	-	M9-24B70D-0040	-	
5	5	51	14	2	0,3	M9-24B700-0050	-	M9-24B70D-0050	-	
6	6	57	16	2	0,5	M9-24B700-0060	M9-24B700-0060-B	M9-24B701-0060	M9-24B701-0060-B	
6	6	57	16	2	1	-	-	M9-24B703-0060	M9-24B703-0060-B	
8	8	63	20	2	0,5	M9-24B700-0080	M9-24B700-0080-B	M9-24B701-0080	M9-24B701-0080-B	
8	8	63	20	2	1	-	-	M9-24B703-0080	M9-24B703-0080-B	
10	10	72	22	2	0,5	M9-24B700-0100	M9-24B700-0100-B	M9-24B701-0100	M9-24B701-0100-B	
12	12	83	32	2	0,5	M9-24B700-0120	M9-24B700-0120-B	M9-24B701-0120	M9-24B701-0120-B	
14	14	83	32	2	0,5	M9-24B700-0140	M9-24B700-0140-B	M9-24B701-0140	M9-24B701-0140-B	
16	16	92	36	2	0,5	M9-24B700-0160	M9-24B700-0160-B	M9-24B701-0160	M9-24B701-0160-B	
18	18	92	45	2	1	M9-24B700-0180	M9-24B700-0180-B	M9-24B703-0180	M9-24B703-0180-B	
20	20	104	50	2	1	M9-24B700-0200	M9-24B700-0200-B	M9-24B703-0200	M9-24B703-0200-B	

ISO	V _c [m/min]	d ₁ [mm]											
		3	4	5	6	8	10	12	14	16	18	20	
N	N1-N2	180-270	0,035	0,045	0,050	0,060	0,090	0,110	0,135	0,145	0,155	0,180	0,200
	N3-N4	380-480	0,045	0,055	0,065	0,080	0,150	0,160	0,170	0,200	0,230	0,250	0,270
	N7-N9	180-270	0,010	0,015	0,020	0,025	0,030	0,035	0,050	0,050	0,055	0,090	0,100

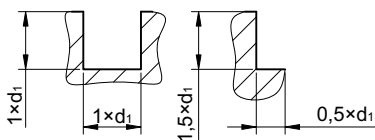

Do obróbki aluminium, jego stopów oraz metali nieżelaznych

AL

B245

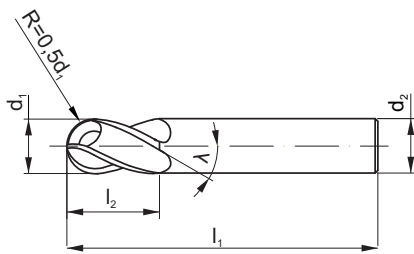

Rodzaj materiału obrabianego



Chwył



Rodzaj materiału

VHM

Powłoka

TB

Naroże



d ₁	d ₂	l ₁	l ₂	Z	R	INDEX
3	3	39	12	2	1,5	M9-24B70X-0030
4	4	51	12	2	2	M9-24B70X-0040
5	5	51	14	2	2,5	M9-24B70X-0050
6	6	57	16	2	3	M9-24B70X-0060
8	8	63	20	2	4	M9-24B70X-0080
10	10	72	22	2	5	M9-24B70X-0100
12	12	83	32	2	6	M9-24B70X-0120
16	16	92	36	2	8	M9-24B70X-0160

ISO	V _c [m/min]	d, [mm]								
		3	4	5	6	8	10	12	16	
N	N1-N4	230-350	fz [mm]	fz [mm]	fz [mm]	fz [mm]	fz [mm]	fz [mm]	fz [mm]	fz [mm]
	N7-N9	130-170	0,030	0,035	0,040	0,050	0,070	0,085	0,110	0,175
			0,007	0,008	0,010	0,015	0,025	0,030	0,040	0,055

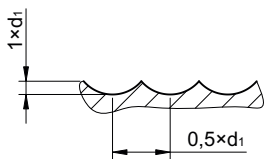

Do obróbki aluminium, jego stopów oraz metali nieżelaznych							AL						
							345	345	R345	R345			
Rodzaj materiału obrabianego													
Chwył													
Rodzaj materiału							VHM	VHM	VHM	VHM			
Powłoka							-	-	-	-			
Naroże													
d ₁	d ₂	l ₁	l ₂	Z	R	INDEX							
3	3	39	12	3	0,3	M9-341700-0030	-	M9-34170D-0030	-				
4	4	51	12	3	0,3	M9-341700-0040	-	M9-34170D-0040	-				
5	5	51	14	3	0,3	M9-341700-0050	-	M9-34170D-0050	-				
6	6	57	16	3	0,5	M9-341700-0060	M9-341700-0060-B	M9-341701-0060	M9-341701-0060-B				
6	6	57	16	3	1	-	-	M9-341703-0060	M9-341703-0060-B				
8	8	63	20	3	0,5	M9-341700-0080	M9-341700-0080-B	M9-341701-0080	M9-341701-0080-B				
8	8	63	20	3	1	-	-	M9-341703-0080	M9-341703-0080-B				
8	8	63	20	3	2	-	-	M9-341705-0080	M9-341705-0080-B				
10	10	72	22	3	0,5	M9-341700-0100	M9-341700-0100-B	M9-341701-0100	M9-341701-0100-B				
10	10	72	22	3	1	-	-	M9-341703-0100	M9-341703-0100-B				
10	10	72	22	3	1,5	-	-	M9-341704-0100	M9-341704-0100-B				
10	10	72	22	3	2	-	-	M9-341705-0100	M9-341705-0100-B				
10	10	72	22	3	2,5	-	-	M9-341706-0100	M9-341706-0100-B				
12	12	83	32	3	0,5	M9-341700-0120	M9-341700-0120-B	M9-341701-0120	M9-341701-0120-B				
12	12	83	32	3	1	-	-	M9-341703-0120	M9-341703-0120-B				
12	12	83	32	3	1,5	-	-	M9-341704-0120	M9-341704-0120-B				
12	12	83	32	3	2	-	-	M9-341705-0120	M9-341705-0120-B				
12	12	83	32	3	2,5	-	-	M9-341706-0120	M9-341706-0120-B				
12	12	83	32	3	3	-	-	M9-341707-0120	M9-341707-0120-B				
ISO	V _c [m/min]	d ₁ [mm]											
		3	4	5	6	8	10	12	14	16	18	20	
N	N1-N4	350-450	fz [mm]	fz [mm]	fz [mm]	fz [mm]	fz [mm]	fz [mm]	fz [mm]	fz [mm]	fz [mm]	fz [mm]	fz [mm]
	N7-N9	160-280	0,020	0,030	0,040	0,055	0,070	0,085	0,100	0,115	0,135	0,150	0,200
			0,020	0,030	0,040	0,550	0,070	0,090	0,095	0,105	0,120	0,140	0,150

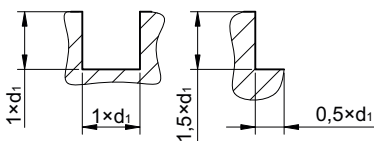

Do obróbki aluminium, jego stopów oraz metali nieżelaznych

AL

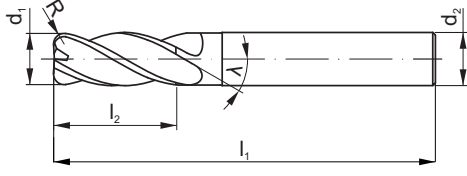
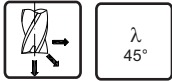

Rodzaj materiału obrabianego



Chwył



Rodzaj materiału

VHM

VHM

VHM

VHM

Powłoka

-

-

-

-

Naroże



d ₁	d ₂	l ₁	l ₂	Z	R	INDEX			
14	14	83	32	3	0,5	M9-341700-0140	M9-341700-0140-B	M9-341701-0140	M9-341701-0140-B
14	14	83	32	3	1	-	-	M9-341703-0140	M9-341703-0140-B
16	16	92	36	3	0,5	M9-341700-0160	M9-341700-0160-B	M9-341701-0160	M9-341701-0160-B
16	16	92	36	3	1	-	-	M9-341703-0160	M9-341703-0160-B
16	16	92	36	3	2	-	-	M9-341705-0160	M9-341705-0160-B
16	16	92	36	3	2,5	-	-	M9-341706-0160	M9-341706-0160-B
16	16	92	36	3	3	-	-	M9-341707-0160	M9-341707-0160-B
18	18	92	45	3	1	M9-341700-0180	M9-341700-0180-B	M9-341703-0180	M9-341703-0180-B
20	20	104	50	3	1	M9-341700-0200	M9-341700-0200-B	M9-341703-0200	M9-341703-0200-B
20	20	104	50	3	2	-	-	M9-341705-0200	M9-341705-0200-B
20	20	104	50	3	3	-	-	M9-341707-0200	M9-341707-0200-B
20	20	104	50	3	4	-	-	M9-341708-0200	M9-341708-0200-B

ISO	V _c [m/min]	d ₁ [mm]											
		3	4	5	6	8	10	12	14	16	18	20	
		fz [mm]	fz [mm]	fz [mm]	fz [mm]	fz [mm]	fz [mm]	fz [mm]	fz [mm]	fz [mm]	fz [mm]	fz [mm]	fz [mm]
N	N1-N4	350-450	0,020	0,030	0,054	0,069	0,085	0,100	0,115	0,135	0,150	0,200	0,220
	N7-N9	160-280	0,020	0,030	0,040	0,055	0,070	0,090	0,095	0,105	0,120	0,140	0,150

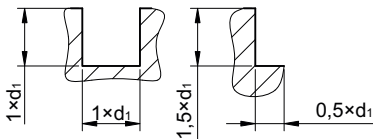

Do obróbki aluminium, jego stopów oraz metali nieżelaznych						AL			
						345	345	R345	R345
Rodzaj materiału obrabianego									
Chwył									
Rodzaj materiału						VHM			
Powłoka						TB			
Naroże									
d ₁	d ₂	l ₁	l ₂	Z	R	INDEX			
14	14	83	32	3	0,5	M9-34B700-0140	M9-34B700-0140-B	M9-34B701-0140	M9-34B701-0140-B
14	14	83	32	3	1	-	-	M9-34B703-0140	M9-34B703-0140-B
16	16	92	36	3	0,5	M9-34B700-0160	M9-34B700-0160-B	M9-34B701-0160	M9-34B701-0160-B
16	16	92	36	3	1	-	-	M9-34B703-0160	M9-34B703-0160-B
16	16	92	36	3	2	-	-	M9-34B705-0160	M9-34B705-0160-B
16	16	92	36	3	2,5	-	-	M9-34B706-0160	M9-34B706-0160-B
16	16	92	36	3	3	-	-	M9-34B707-0160	M9-34B707-0160-B
18	18	92	45	3	1	M9-34B700-0180	M9-34B700-0180-B	M9-34B703-0180	M9-34B703-0180-B
20	20	104	50	3	1	M9-34B700-0200	M9-34B700-0200-B	M9-34B703-0200	M9-34B703-0200-B
20	20	104	50	3	2	-	-	M9-34B705-0200	M9-34B705-0200-B
20	20	104	50	3	3	-	-	M9-34B707-0200	M9-34B707-0200-B
20	20	104	50	3	4	-	-	M9-34B708-0200	M9-34B708-0200-B

ISO	V _c [m/min]	d ₁ [mm]											
		3	4	5	6	8	10	12	14	16	18	20	
N	N1-N4	350-450	fz [mm]	fz [mm]	fz [mm]	fz [mm]	fz [mm]	fz [mm]	fz [mm]	fz [mm]	fz [mm]	fz [mm]	fz [mm]
	N7-N9	160-280	0,020	0,030	0,054	0,069	0,085	0,100	0,115	0,135	0,150	0,200	0,220
			0,020	0,030	0,040	0,055	0,070	0,090	0,095	0,105	0,120	0,140	0,150

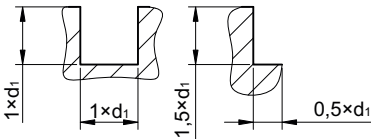

Do obróbki aluminium, jego stopów oraz metali nieżelaznych

AL

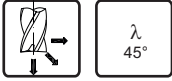

VHM

TB

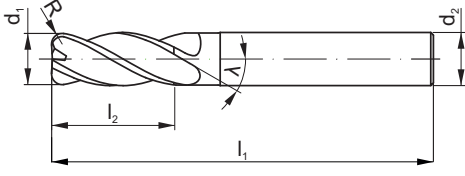

Rodzaj materiału obrabianego



Chwyt



Rodzaj materiału

VHM

VHM

VHM

VHM

Powłoka

TB

TB

TB

TB

Naroże



d ₁	d ₂	l ₁	l ₂	Z	R	INDEX			
3	3	39	12	3	0,3	M9-34B700-0030	-	M9-34B70D-0030	-
4	4	51	12	3	0,3	M9-34B700-0040	-	M9-34B70D-0040	-
5	5	51	14	3	0,3	M9-34B700-0050	-	M9-34B70D-0050	-
6	6	57	16	3	0,5	M9-34B700-0060	M9-34B700-0060-B	M9-34B701-0060	M9-34B701-0060-B
6	6	57	16	3	1	-	-	M9-34B703-0060	M9-34B703-0060-B
8	8	63	20	3	0,5	M9-34B700-0080	M9-34B700-0080-B	M9-34B701-0080	M9-34B701-0080-B
8	8	63	20	3	1	-	-	M9-34B703-0080	M9-34B703-0080-B
8	8	63	20	3	2	-	-	M9-34B705-0080	M9-34B705-0080-B
10	10	72	22	3	0,5	M9-34B700-0100	M9-34B700-0100-B	M9-34B701-0100	M9-34B701-0100-B
10	10	72	22	3	1	-	-	M9-34B703-0100	M9-34B703-0100-B
10	10	72	22	3	1,5	-	-	M9-34B704-0100	M9-34B704-0100-B
10	10	72	22	3	2	-	-	M9-34B705-0100	M9-34B705-0100-B
10	10	72	22	3	2,5	-	-	M9-34B706-0100	M9-34B706-0100-B
12	12	83	32	3	0,5	M9-34B700-0120	M9-34B700-0120-B	M9-34B701-0120	M9-34B701-0120-B
12	12	83	32	3	1	-	-	M9-34B703-0120	M9-34B703-0120-B
12	12	83	32	3	1,5	-	-	M9-34B704-0120	M9-34B704-0120-B
12	12	83	32	3	2	-	-	M9-34B705-0120	M9-34B705-0120-B
12	12	83	32	3	2,5	-	-	M9-34B706-0120	M9-34B706-0120-B
12	12	83	32	3	3	-	-	M9-34B707-0120	M9-34B707-0120-B

ISO	V _c [m/min]	d ₁ [mm]											
		3	4	5	6	8	10	12	14	16	18	20	
N	N1-N4	350-450	0,020	0,030	0,054	0,069	0,085	0,100	0,115	0,135	0,150	0,200	0,220
	N7-N9	160-280	0,020	0,030	0,040	0,055	0,070	0,090	0,095	0,105	0,120	0,140	0,150

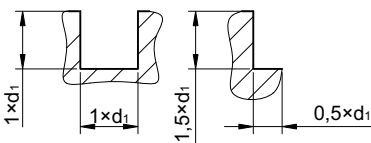

Do obróbki aluminium, jego stopów oraz metali nieżelaznych							AL 345NL						
Z=3 λ 45° VHM TB 													
Rodzaj materiału obrabianego													
Chwył													
Rodzaj materiału							VHM						
Powłoka							TB						
Naroże													
d ₁	d ₂ h6	d ₃	l ₁	l ₂	l ₃	Z	INDEX						
3	6	2,7	57	7	17	3	M9-34B7A0-0030						
4	6	3,7	63	8	22	3	M9-34B7A0-0040						
5	6	4,7	67	10	27	3	M9-34B7A0-0050						
6	6	5,5	74	10	32	3	M9-34B7A0-0060						
8	8	7,5	90	12	46	3	M9-34B7A0-0080						
10	10	9,2	102	14	55	3	M9-34B7A0-0100						
12	12	11	117	16	64	3	M9-34B7A0-0120						
16	16	15	141	22	87	3	M9-34B7A0-0160						

ISO	V _c [m/min]	d, [mm]											
		3	4	5	6	8	10	12	14	16	18	20	
		fz [mm]	fz [mm]	fz [mm]	fz [mm]	fz [mm]	fz [mm]	fz [mm]	fz [mm]	fz [mm]	fz [mm]	fz [mm]	fz [mm]
N	N1-N4	150-250	0,020	0,030	0,055	0,070	0,085	0,100	0,115	0,135	0,150	0,200	0,220
	N7-N9	100-200	0,020	0,030	0,040	0,550	0,070	0,090	0,100	0,105	0,120	0,140	0,150

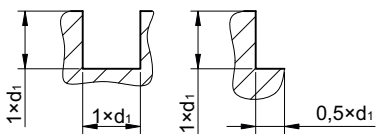

Do obróbki aluminium, jego stopów oraz metali nieżelaznych

AL

B345NL

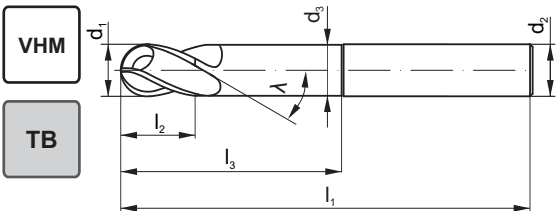
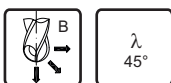

Rodzaj materiału obrabianego



Chwył



Rodzaj materiału

VHM

Powłoka

TB

Naroże



d ₁	d ₂ h6	d ₃	l ₁	l ₂	l ₃	Z	R	INDEX
3	6	2,7	57	7	17	3	1,5	M9-34B7AX-0030
4	6	3,7	63	8	22	3	2	M9-34B7AX-0040
5	6	4,7	67	10	27	3	2,5	M9-34B7AX-0050
6	6	5,5	74	10	32	3	3	M9-34B7AX-0060
8	8	7,5	90	12	46	3	4	M9-34B7AX-0080
10	10	9,2	102	14	55	3	5	M9-34B7AX-0100
12	12	11	117	16	64	3	6	M9-34B7AX-0120
16	16	15	141	22	87	3	8	M9-34B7AX-0160

ISO	V _c [m/min]	d, [mm]									
		3	4	5	6	8	10	12	14	16	
N	N1-N4	150-250	0,020	0,030	0,055	0,070	0,085	0,100	0,115	0,135	0,150
	N7-N9	100-200	0,020	0,030	0,040	0,550	0,070	0,090	0,100	0,105	0,120

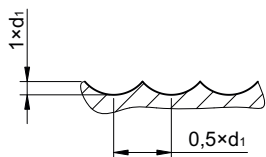

7

Do obróbki aluminium, jego stopów oraz metali nieżelaznych					AL								
					445	445							
Rodzaj materiału obrabianego													
Chwył													
Rodzaj materiału					VHM								
Powłoka					-								
Naroże													
d ₁	d ₂	l ₁	l ₂	Z	INDEX								
3	3	39	12	4	M9-441700-0030	-							
4	4	51	12	4	M9-441700-0040	-							
5	5	51	15	4	M9-441700-0050	-							
6	6	57	18	4	M9-441700-0060	M9-441700-0060-B							
8	8	63	24	4	M9-441700-0080	M9-441700-0080-B							
10	10	72	30	4	M9-441700-0100	M9-441700-0100-B							
12	12	83	36	4	M9-441700-0120	M9-441700-0120-B							
14	14	83	42	4	M9-441700-0140	M9-441700-0140-B							
16	16	92	48	4	M9-441700-0160	M9-441700-0160-B							
18	18	92	54	4	M9-441700-0180	M9-441700-0180-B							
20	20	104	60	4	M9-441700-0200	M9-441700-0200-B							
ISO	V _c [m/min]	d ₁ [mm]											
		3	4	5	6	8	10	12	14	16	18	20	
N	N1-N4	270-400	0,025	0,035	0,045	0,055	0,060	0,065	0,070	0,075	0,080	0,090	0,110
	N7-N9	130-250	0,020	0,030	0,035	0,040	0,045	0,050	0,055	0,060	0,075	0,085	0,090

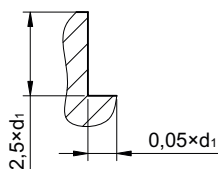

Do obróbki aluminium, jego stopów oraz metali nieżelaznych

ALZGR

R338

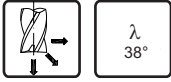

VHM

TB

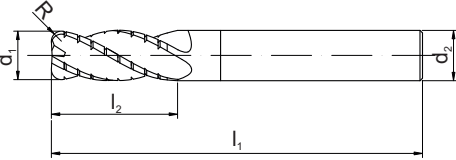

Rodzaj materiału obrabianego



Chwyt



Rodzaj materiału

VHM

Powłoka

TB

Naroże



d_1	d_2 h6	l_1	l_2	Z	R	INDEX
6	6	57	16	3	0,5	M9-33B701-0060
8	8	63	20	3	0,5	M9-33B701-0080
10	10	72	22	3	1	M9-33B703-0100
12	12	83	26	3	1	M9-33B703-0120
16	16	92	32	3	2	M9-33B705-0160

ISO	V_c [m/min]	d_1 [mm]					
		6	8	10	12	16	
		f_z [mm]	f_z [mm]	f_z [mm]	f_z [mm]	f_z [mm]	
N	N1-N4	380-600	0,06	0,09	0,12	0,14	0,2
	N7-N9	230-400	0,06	0,09	0,12	0,14	0,2

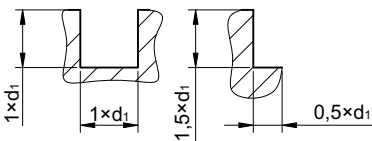

7

Frez wielofunkcyjny do frezowania kanazków, profilowania, wiercenia, nawiercania, fazowania i grawerowania											
<div style="display: flex; align-items: center;"> <div style="border: 1px solid black; padding: 2px; margin-right: 10px;">VHM</div> <div style="border: 1px solid black; padding: 2px; margin-right: 10px;">AT</div> </div> <p style="text-align: center;">Średnica wierzchołka 0,1 x d₁</p>											
Rodzaj materiału obrabianego				<table border="1" style="font-size: small;"> <tr><td>P</td><td>M</td><td>K</td></tr> <tr><td>N</td><td>S</td><td>H</td></tr> </table>		P	M	K	N	S	H
P	M	K									
N	S	H									
Rodzaj powłoki				AT							
Materiał narzędzia				VHM							
Kąt wierzchołkowy				90°							
d ₁	d ₂	l ₁	l _{2 min}	INDEX							
1,0	3,00	39	2,0	M9-80V001-0100							
1,5	3,00	39	3,0	M9-80V001-0150							
2,0	3,00	39	4,0	M9-80V001-0200							
2,5	3,00	39	5,0	M9-80V001-0250							
3,0	4,00	50	6,0	M9-80V001-0300							
4,0	5,00	50	8,0	M9-80V001-0400							
5,0	6,00	50	10,0	M9-80V001-0500							
6,0	8,00	60	12,0	M9-80V001-0600							
8,0	10,00	70	16,0	M9-80V001-0800							
10,0	12,00	70	18,0	M9-80V001-1000							
12,0	12,00	70	20,0	M9-80V001-1200							

Nawiercanie/wiercenie

		Posuw na ostrze [mm/ostrze]										
		Vc (m/min)	Ø0,3	Ø0,5	Ø1	Ø2	Ø3	Ø5	Ø8	Ø12	Ø16	Ø20
P	Rm<500	60-75	0,003	0,005	0,012	0,025	0,050	0,100	0,150	0,200	0,250	0,300
	Rm<800	40-60	0,003	0,005	0,012	0,025	0,050	0,100	0,150	0,200	0,250	0,300
	Rm<1000	35-40	0,003	0,005	0,010	0,023	0,045	0,070	0,120	0,180	0,220	0,280
	Rm<1400	30-35	0,002	0,004	0,009	0,023	0,045	0,070	0,120	0,170	0,220	0,260
M	25-30	0,002	0,004	0,010	0,020	0,040	0,060	0,110	0,160	0,220	0,250	
K	30-35	0,002	0,004	0,009	0,023	0,045	0,070	0,120	0,170	0,220	0,260	
N	50-150	0,003	0,005	0,020	0,040	0,070	0,120	0,200	0,250	0,320	0,400	
S	15-20	0,002	0,004	0,010	0,020	0,040	0,060	0,110	0,160	0,200	0,250	

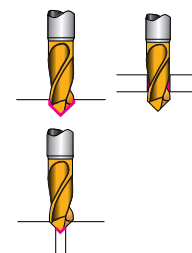
Frezowanie kanazków

		Posuw na ostrze [mm/ostrze]										
		Vc (m/min)	Ø0,3	Ø0,5	Ø1	Ø2	Ø3	Ø5	Ø8	Ø12	Ø16	Ø20
P	Rm<500	60-75	0,002	0,003	0,005	0,008	0,010	0,018	0,030	0,040	0,050	0,065
	Rm<800	40-60	0,001	0,002	0,004	0,008	0,010	0,015	0,030	0,040	0,050	0,065
	Rm<1000	35-40	0,001	0,002	0,004	0,008	0,010	0,015	0,030	0,040	0,050	0,065
	Rm<1400	30-35	0,001	0,002	0,004	0,006	0,008	0,012	0,025	0,032	0,040	0,055
M	25-30	0,001	0,002	0,004	0,006	0,008	0,012	0,025	0,032	0,040	0,055	
K	30-35	0,001	0,002	0,004	0,006	0,008	0,012	0,025	0,032	0,040	0,055	
N	50-150	0,001	0,003	0,006	0,012	0,016	0,020	0,034	0,040	0,060	0,080	
S	15-20	0,001	0,001	0,003	0,005	0,006	0,010	0,020	0,026	0,036	0,050	

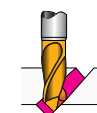
Grawerowanie/Fazowanie/Profilowanie

		Posuw na ostrze [mm/ostrze]										
		Vc (m/min)	Ø0,3	Ø0,5	Ø1	Ø2	Ø3	Ø5	Ø8	Ø12	Ø16	Ø20
P	Rm<500	60-75	0,002	0,004	0,008	0,012	0,015	0,020	0,038	0,060	0,080	0,100
	Rm<800	40-60	0,002	0,004	0,008	0,012	0,015	0,020	0,038	0,060	0,080	0,100
	Rm<1000	35-40	0,002	0,003	0,008	0,012	0,014	0,020	0,038	0,060	0,080	0,090
	Rm<1400	30-35	0,001	0,003	0,007	0,012	0,014	0,020	0,038	0,055	0,075	0,080
M	25-30	0,011	0,002	0,005	0,010	0,012	0,018	0,035	0,050	0,065	0,080	
K	30-35	0,001	0,003	0,007	0,012	0,014	0,020	0,038	0,055	0,075	0,080	
N	50-150	0,002	0,005	0,009	0,018	0,014	0,022	0,042	0,065	0,072	0,095	
S	15-20	0,001	0,002	0,005	0,010	0,012	0,018	0,035	0,050	0,065	0,080	

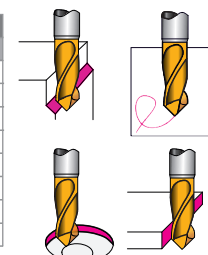
Przykład zamawiania
M9-80V001-0100
Frez wielofunkcyjny MultiCUT 90° 1x3x2x39 VHM AT

- Dostępne z magazynu
- Na zapytanie

Do otworów pod gwinty NPT, NPTF, BSPT (1:16)



Z=4



λ
30°

VHM

TS

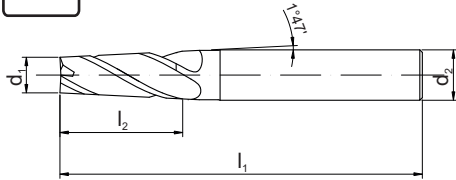

Rodzaj materiału obrabianego



Chwył



Rodzaj materiału

VHM

Powłoka

TS

Naroże



d_1	$d_2, h6$	l_1	l_2	Z	Pod gwinty	INDEX
5,2	6	58	12	4	1/16" - 1/8"	M9-43GD00-0052
8,5	10	73	24	4	1/8" - 1"	M9-43GD00-0085
10	12	84	33	4	1/4" - 3"	M9-43GD00-0100

SPRAWDZIANY





A	MSBa	Sprawdziany tłoczkowe do otworów	217
M	MSBg	Sprawdziany gwintowe trzpieniowe	218
	MSRh	Sprawdziany gwintowe pierścieniowe przechodnie	
	MSRk	Sprawdziany gwintowe pierścieniowe nieprzechodnie	
MF	MSBg	Sprawdziany gwintowe trzpieniowe	219 - 220
	MSRh	Sprawdziany gwintowe pierścieniowe przechodnie	
	MSRk	Sprawdziany gwintowe pierścieniowe nieprzechodnie	
UNC	MSBg	Sprawdziany gwintowe trzpieniowe	221
	MSRh	Sprawdziany gwintowe pierścieniowe przechodnie	
	MSRk	Sprawdziany gwintowe pierścieniowe nieprzechodnie	
UNF	MSBg	Sprawdziany gwintowe trzpieniowe	222
	MSRh	Sprawdziany gwintowe pierścieniowe przechodnie	
	MSRk	Sprawdziany gwintowe pierścieniowe nieprzechodnie	
G	MSBg	Sprawdziany gwintowe trzpieniowe	223
	MSRh	Sprawdziany gwintowe pierścieniowe przechodnie	
	MSRk	Sprawdziany gwintowe pierścieniowe nieprzechodnie	
R Rc/Rp	MSXa	Sprawdziany gwintowe trzpieniowe	224
	MSXc	Sprawdziany gwintowe pierścieniowe	
Pg	MSBg	Sprawdziany gwintowe trzpieniowe	225
	MSRh	Sprawdziany gwintowe pierścieniowe przechodnie	
	MSRc	Sprawdziany gwintowe pierścieniowe nieprzechodnie	
BSW	MSBg	Sprawdziany gwintowe trzpieniowe	226
	MSRh	Sprawdziany gwintowe pierścieniowe przechodnie	
	MSRk	Sprawdziany gwintowe pierścieniowe nieprzechodnie	
NPT	MSXa	Sprawdziany gwintowe trzpieniowe	227
	MSXc	Sprawdziany gwintowe pierścieniowe	
Tr	MSBg	Sprawdziany gwintowe trzpieniowe	228
	MSRh	Sprawdziany gwintowe pierścieniowe przechodnie	
	MSRk	Sprawdziany gwintowe pierścieniowe nieprzechodnie	

Wymiary sprawdzianów według normy PN-EN ISO 1938-1:2016-03									
Typ sprawdzianu GO - Przechodni NOGO - Nieprzechodni									
		MSBa	MSBa						
Symbol		MSBa	MSBa						
Typ		GO / NOGO	GO / NOGO						
Ø nom.	Tol	H7	H8						
	INDEX	S3-100111	S3-100112						
1	0010	●	○						
1,2	0012	●	○						
1,5	0015	●	○						
1,8	0018	●	○						
2	0020	●	○						
2,2	0022	●	○						
2,5	0025	●	○						
2,8	0028	●	○						
3	0030	●	○						
3,5	0035	○	○						
4	0040	●	○						
4,5	0045	○	○						
5	0050	●	○						
6	0060	●	○						
7	0070	○	○						
8	0080	●	○						
9	0090	○	○						
10	0100	●	○						
12	0120	●	○						
14	0140	●	○						
16	0160	●	○						
18	0180	●	○						
20	0200	●	○						
22	0220	●	○						
24	0240	●	○						
25	0250	●	○						
26	0260	●	○						
27	0270	○	○						
28	0280	●	○						
30	0300	●	○						
32	0320	●	○						
33	0330	●	○						
34	0340	●	○						
35	0350	●	○						
36	0360	●	○						
37	0370	●	○						
38	0380	●	○						
40	0400	●	○						
42	0420	●	○						
44	0440	○	○						
45	0450	●	○						
46	0460	○	○						
47	0470	●	○						
48	0480	○	○						
50	0500	●	○						
52	0520	○	○						



Powyżej Ø42 sprawdziany przechodnie mają symbol MSCb, a nieprzechodnie MSCc i wykonywane są z rękojeściami oddzielnymi

Gwint metryczny zwykły ISO DIN-13								
								
Typ sprawdzianu GO - Przechodni NOGO - Nieprzechodni								
Symbol				MSBg	MSBg LH	MSBg	MSRh	MSRk
Typ				GO / NOGO	GO / NOGO	GO / NOGO	GO	NOGO
M	P	Tol	INDEX	6H	6H	6G	6g	6g
				S3-302161	S3-301161	S3-302162	Y3-412162	Y3-422162
M 1	0,25	0010	●	○	○	●	●	
M 1,2	0,25	0012	●	○	○	●	●	
M 1,4	0,3	0014	●	○	○	●	●	
M 1,6	0,35	0016	●	○	○	●	●	
M 1,7	0,35	0017	●	○	○	●	●	
M 1,8	0,35	0018	●	○	○	●	●	
M 2	0,4	0020	●	○	○	●	●	
M 2,2	0,45	0022	●	○	○	●	●	
M 2,5	0,45	0025	●	○	○	●	●	
M 2,6	0,45	0026	●	○	○	●	●	
M 3	0,5	0030	●	○	○	●	●	
M 3,5	0,6	0035	●	○	○	●	●	
M 4	0,7	0040	●	○	○	●	●	
M 4,5	0,75	0045	●	○	○	●	●	
M 5	0,8	0050	●	○	○	●	●	
M 6	1	0060	●	○	○	●	●	
M 7	1	0070	●	○	○	●	●	
M 8	1,25	0080	●	○	○	●	●	
M 9	1,25	0090	●	○	○	●	●	
M 10	1,5	0100	●	○	○	●	●	
M 12	1,75	0120	●	○	○	●	●	
M 14	2	0140	●	○	○	●	●	
M 16	2	0160	●	○	○	●	●	
M 18	2,5	0180	●	○	○	●	●	
M 20	2,5	0200	●	○	○	●	●	
M 22	2,5	0220	●	○	○	●	●	
M 24	3	0240	●	○	○	●	●	
M 27	3	0270	●	○	○	●	●	
M 30	3,5	0300	●	○	○	●	●	
M 33	3,5	0330	●	○	○	●	●	
M 36	4	0360	●	○	○	●	●	
M 39	4	0390	●	○	○	●	●	
M 42	4,5	0420	○	○	○	●	●	
M 45	4,5	0450	○	○	○	●	●	
M 48	5	0480	○	○	○	●	●	
M 52	5	0520	○	○	○	●	●	



Zestaw sprawdzianów str. 263



Powyżej M42 sprawdziany trzpieniowe przechodnie mają symbol MSCh, a nieprzechodnie MSChk i wykonywane są z rękojeściami oddzielnymi

Gwint metryczny zwykły ISO DIN-13								
Symbol				MSBg	MSBg LH	MSBg	MSRh	MSRk
Typ				GO / NOGO	GO / NOGO	GO / NOGO	GO	NOGO
MF	P	Tol	INDEX	6H	6H	6G	6g	6g
				S3-302161	S3-301161	S3-302162	Y3-412162	Y3-422162
M 3 x 0,35	0,35		0031	○	○	○	○	○
M 3,5 x 0,35	0,35		0036	○	○	○	○	○
M 4 x 0,35	0,35		0043	○	○	○	○	○
M 4x0,5	0,5		0041	○	○	○	○	○
M 4,5 x 0,5	0,5		0046	○	○	○	○	○
M 5 x 0,5	0,5		0051	○	○	○	○	○
M 6 x 0,5	0,5		0061	○	○	○	○	○
M 6 x 0,75	0,75		0062	○	○	○	○	○
M 8 x 0,5	0,5		0081	○	○	○	○	○
M 8 x 0,75	0,75		0082	○	○	○	○	○
M 8 x 1	1		0083	●	●	○	●	●
M 9 x 1	1		0093	○	○	○	○	○
M 10 x 0,75	0,75		0102	○	○	○	○	○
M 10 x 1	1		0103	●	●	○	●	●
M 10 x 1,25	1,25		0104	●	●	○	●	●
M 11 x 1	1		0113	○	○	○	○	○
M 12 x 1	1		0123	●	●	○	●	●
M 12 x 1,25	1,25		0124	●	●	○	●	●
M 12 x 1,5	1,5		0125	●	●	○	●	●
M 13 x 1	1		0133	○	○	○	○	○
M 14 x 1	1		0143	○	○	○	○	○
M 14 x 1,25	1,25		0144	○	○	○	○	○
M 14 x 1,5	1,5		0145	●	●	○	●	●
M 15 x 1	1		0153	○	○	○	○	○
M 15 x 1,5	1,5		0155	○	○	○	○	○
M 16 x 1	1		0163	●	●	○	●	●
M 16 x 1,5	1,5		0165	●	●	○	●	●
M 18 x 1	1		0183	○	○	○	○	○
M 18 x 1,5	1,5		0185	●	●	○	●	●
M 18 x 2	2		0186	○	○	○	○	○
M 20 x 1	1		0203	●	●	○	●	●
M 20 x 1,5	1,5		0205	●	●	○	●	●
M 20 x 2	2		0206	○	○	○	○	○
M 22 x 1	1		0223	○	○	○	○	○
M 22 x 1,5	1,5		0225	●	●	○	●	●
M 22 x 2	2		0226	●	●	○	●	●
M 24 x 1	1		0243	○	○	○	○	○
M 24 x 1,5	1,5		0245	●	●	○	●	●
M 24 x 2	2		0246	●	○	○	○	○
M 25 x 1,5	1,5		0255	●	○	○	○	○
M 26 x 1,5	1,5		0265	●	○	○	○	○
M 27 x 1,5	1,5		0275	●	○	○	○	○

Gwint metryczny drobnozwojny ISO DIN-13								
								
Typ sprawdzianu GO - Przechodni NOGO - Nieprzechodni								
Symbol				MSBg	MSBg LH	MSBg	MSRh	MSRk
Typ				GO / NOGO	GO / NOGO	GO / NOGO	GO	NOGO
MF	P	ToI	INDEX	6H	6H	6G	6g	6g
				S3-302161	S3-301161	S3-302162	Y3-412162	Y3-422162
M 27 x 2	2	0276	●	○	○	○	○	○
M 28 x 1,5	1,5	0285	●	○	○	○	○	○
M 28 x 2	2	0286	○	○	○	○	○	○
M 30 x 1	1	0303	○	○	○	○	○	○
M 30 x 1,5	1,5	0305	●	○	○	○	○	○
M 30 x 2	2	0306	●	○	○	○	○	○
M 32 x 1,5	1,5	0325	●	○	○	○	○	○
M 33 x 1,5	1,5	0335	●	○	○	○	○	○
M 33 x 2	2	0336	●	○	○	○	○	○
M 33 x 3	3	0337	○	○	○	○	○	○
M 34 x 1,5	1,5	0345	○	○	○	○	○	○
M 35 x 1,5	1,5	0355	●	○	○	○	○	○
M 36 x 1,5	1,5	0365	●	○	○	○	○	○
M 36 x 2	2	0366	●	○	○	○	○	○
M 36 x 3	3	0367	○	○	○	○	○	○
M 38 x 1,5	1,5	0385	●	○	○	○	○	○
M 39 x 2	2	0396	●	○	○	○	○	○
M 39 x 3	3	0397	○	○	○	○	○	○
M 40 x 1,5	1,5	0405	●	○	○	○	○	○
M 40 x 2	2	0406	○	○	○	○	○	○
M 40 x 3	3	0407	○	○	○	○	○	○
M 42 x 1,5	1,5	0425	○	○	○	○	○	○
M 42 x 2	2	0426	○	○	○	○	○	○
M 42 x 3	3	0427	○	○	○	○	○	○
M 45 x 1,5	1,5	0455	○	○	○	○	○	○
M 45 x 2	2	0456	○	○	○	○	○	○
M 45 x 3	3	0457	○	○	○	○	○	○
M 48 x 1,5	1,5	0485	○	○	○	○	○	○
M 48 x 2	2	0486	○	○	○	○	○	○
M 48 x 3	3	0487	○	○	○	○	○	○
M 50 x 1,5	1,5	0505	○	○	○	○	○	○
M 50 x 2	2	0506	○	○	○	○	○	○
M 50 x 3	3	0507	○	○	○	○	○	○
M 52 x 1,5	1,5	0525	○	○	○	○	○	○
M 52 x 2	2	0526	○	○	○	○	○	○
M 52 x 3	3	0527	○	○	○	○	○	○



Zestaw sprawdzianów str. 263



Powyżej M42 sprawdziany trzpieniowe przechodnie mają symbol MSCh, a nieprzechodnie MSChk i wykonywane są z rękojeściami oddzielnymi

Gwint amerykański zunifikowany UNC, ANSI B-1.1							
							
Typ sprawdzianu GO - Przechodni NOGO - Nieprzechodni							
Symbol				MSBg		MSRk	
Typ				GO / NOGO		GO / NOGO	
UNC	$\varnothing d_1$	1"/P	Tol	2B	3B	2A	2A
			INDEX	S3-302186	S3-302187	Y3-412182	Y3-422182
No 5 - 40	3,175	40	4105	●	○	○	○
No 6 - 32	3,505	32	4106	●	○	○	○
No 8 - 32	4,166	32	4108	●	○	○	○
No 10 - 24	4,826	24	4110	●	○	○	○
No 12 - 24	5,486	24	4112	●	○	○	○
1/4 - 20	6,350	20	4127	●	○	○	○
5/16 - 18	7,938	18	4128	●	○	○	○
3/8 - 16	9,525	16	4129	●	○	○	○
7/16 - 14	11,112	14	4130	●	○	○	○
1/2 - 13	12,700	13	4131	●	○	○	○
9/16 - 12	14,288	12	4132	●	○	○	○
5/8 - 11	15,875	11	4133	●	○	○	○
3/4 - 10	19,050	10	4135	●	○	○	○
7/8 - 9	22,225	9	4137	●	○	○	○
1 - 8	25,400	8	4139	●	○	○	○
1.1/8 - 7	28,575	7	4141	○	○	○	○
1.1/4 - 7	31,750	7	4143	○	○	○	○
1.3/8 - 6	34,925	6	4145	○	○	○	○
1.1/2 - 6	38,100	6	4147	○	○	○	○
1.3/4 - 5	44,450	5	4151	○	○	○	○
2 - 4.1/2	50,800	4.1/2	4155	○	○	○	○



Powyżej 1 3/4" - UNC sprawdziany przechodnie mają symbol MSCh, a nieprzechodnie MSCK i wykonywane są z rękojeściami oddzielnymi



Gwint amerykański zunifikowany drobnozwojny UNF, ANSI B-1.1							
							
Wymiar sprawdzianu według normy ANSI/ASME B1.2							
Typ sprawdzianu GO - Przechodni NOGO - Nieprzechodni							
Symbol				MSBg		MSRk	
Typ				GO / NOGO		GO	
UNF	Ø d _i	1"/P	Tol	2B	3B	2A	2A
			INDEX	S3-302186	S3-302187	Y3-412182	Y3-422182
No 5 - 44	3,175	44	4205	○	○	○	○
No 6 - 40	3,505	40	4206	○	○	○	○
No 8 - 36	4,166	36	4208	○	○	○	○
No 10 - 32	4,826	32	4210	○	○	○	○
No 12 - 28	5,486	28	4212	○	○	○	○
1/4 - 28	6,350	28	4227	●	○	○	○
5/16 - 24	7,938	24	4228	●	○	○	○
3/8 - 24	9,525	24	4229	●	○	○	○
7/16 - 20	11,112	20	4230	●	○	○	○
1/2 - 20	12,700	20	4231	●	○	○	○
9/16 - 18	14,288	18	4232	●	○	○	○
5/8 - 18	15,875	18	4233	●	○	○	○
3/4 - 16	19,050	16	4235	●	○	○	○
7/8 - 14	22,225	14	4237	●	○	○	○
1 - 12	25,400	12	4239	●	○	○	○
1.1/8 - 12	28,575	12	4241	○	○	○	○
1.1/4 - 12	31,750	12	4243	○	○	○	○
1.3/8 - 12	34,925	12	4245	○	○	○	○
1.1/2 - 12	38,100	12	4247	○	○	○	○



Powyżej 1 3/4" - UNF sprawdziany przechodnie mają symbol MSCh, a nieprzechodnie MSCh i wykonywane są z rękojeściami oddzielnymi

Gwint rurowy walcowy G, DIN-ISO 228						
Wymiar sprawdzianu według normy ISO 228-2						
Typ sprawdzianu GO - Przechodni NOGO - Nieprzechodni						
Symbol				MSBg	MSRh	MSRk
Typ				GO / NOGO	GO	NOGO
G	Ø d _i	1"/P	Tol	A		A
			INDEX	S3-302180	Y3-412180	Y3-422180
G-1/8"	9,73	28	3123	●	○	○
G-1/4"	13,16	19	3127	●	○	○
G-3/8"	16,66	19	3129	●	●	●
G-1/2"	20,96	14	3131	●	●	●
G-5/8"	22,91	14	3133	○	○	○
G-3/4"	26,44	14	3135	●	●	●
G-7/8"	30,20	14	3137	○	○	○
G-1"	33,25	11	3139	●	●	●
G-1.1/8"	37,90	11	3141	●	○	○
G-1.1/4"	41,91	11	3143	●	○	○



Gwint rurowy do połączeń ze szczelnością uzyskiwaną na gwincie				PN-EN 10226-3 (ISO7-2:2000)					
<p>55° P 1:16 R, Rc Rp</p> <p>PN-EN 10226-1, PN-EN 10226-2 (ISO7-1:2000)</p> <p>Gauge system acc. PN-EN 10226-3 Wymiar sprawdzianu według normy PN-EN 10226-3</p> <p>Typ sprawdzianu GO - Przechodni NOGO - Nieprzechodni</p>									
Symbol				MSXa	MSXa	MSXc	MSXc	MSXa	
Typ				Nr 1	Nr 2	Nr 3	Nr 4	Nr 5	
Rc/Rp	∅ d ₁	1"/P	Tol	Rc/Rp	Rc/Rp	R	R	R	
			INDEX	S3-332101	S3-332102	-	-	S3-332105	
1/16"	7,72	28	3321	o	o			o	
1/8"	9,73	28	3323	o	o			o	
1/4"	13,16	19	3327	o	o			o	
3/8"	16,66	19	3329	o	o			o	
1/2"	20,96	14	3331	o	o			o	
3/4"	26,44	14	3335	o	o			o	
1"	32,25	11	3339	o	o			o	
1.1/4"	41,91	11	3343	o	o			o	
1.1/2"	47,80	11	3347	o	o			o	
2"	59,61	11	3355	o	o			o	
2.1/2"	75,18	11	3359	o	o			o	
3"	87,88	11	3363	o	o			o	
4"	113,03	11	3371	o	o			o	
R	∅ d ₁	1"/P	INDEX	-	-	Y3-432103	Y3-432104	-	
1/16"	7,72	28	3421			o	o		
1/8"	9,73	28	3423			o	o		
1/4"	13,16	19	3427			o	o		
3/8"	16,66	19	3429			o	o		
1/2"	20,96	14	3431			o	o		
3/4"	26,44	14	3435			o	o		
1"	32,25	11	3439			o	o		
1.1/4"	41,91	11	3443			o	o		
1.1/2"	47,80	11	3447			o	o		
2"	59,61	11	3455			o	o		
2.1/2"	75,18	11	3459			o	o		
3"	87,88	11	3463			o	o		
4"	113,03	11	3471			o	o		



Informacje techniczne odnośnie konstrukcji oraz stosowania sprawdzianów R i Rc/Rp w części technicznej katalogu na str. 306

Gwint do rurek instalacyjnych stalowych PG, DIN-40430						
Wymiar sprawdzianu według normy DIN 40431						
Typ sprawdzianu GO - Przechodni NOGO - Nieprzechodni						
Symbol				MSBg	MSRh	MSRc
Typ				GO / NOGO	GO	NOGO
Pg	Ø d _i	1"/P	Tol			
			INDEX	S3-832100	Y3-412100	Y3-450100
Pg 7	12,5	20	8807	○	○	○
Pg 9	15,2	18	8809	○	○	○
Pg 11	18,6	18	8811	○	○	○
Pg 13,5	20,4	18	8813	○	○	○
Pg 16	22,5	18	8816	○	○	○
Pg 21	28,3	16	8821	○	○	○
Pg 29	37	16	8829	○	○	○
Pg 36	47	16	8836	○	○	○



Gwint Pg jest zastępowany gwintem metrycznym drobnozwojnym MF wg normy DIN EN 60423 dostępnym na zapytanie

8

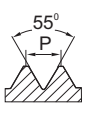

Gwint calowy zwykły Whitwortha BSW, BS-84						
						
Wymiar sprawdzianu według normy BS 919-2						
Typ sprawdzianu GO - Przechodni NOGO - Nieprzechodni						
Symbol				MSBg	MSRh	MSRk
Typ				GO / NOGO	GO	NOGO
BSW	Ø d _t	1"/P	Tol	medium	medium	medium
			INDEX	S3-302100	Y3-412100	Y3-422100
1/8 - 40	3,175	40	7123	○	○	○
3/16 - 24	4,762	24	7125	○	○	○
1/4 - 20	6,350	20	7127	○	○	○
5/16 - 18	7,938	18	7128	○	○	○
3/8 - 16	9,525	16	7129	○	○	○
7/16 - 14	11,112	14	7130	○	○	○
1/2 - 12	12,700	12	7131	○	○	○
9/16 - 12	14,288	12	7132	○	○	○
5/8 - 11	15,875	11	7133	○	○	○
3/4 - 10	19,050	10	7135	○	○	○
7/8 - 9	22,225	9	7137	○	○	○
1 - 8	25,400	8	7139	○	○	○
1.1/8 - 7	28,575	7	7141	○	○	○
1.1/4 - 7	31,750	7	7143	○	○	○
1.3/8 - 6	34,925	6	7145	○	○	○
1.1/2 - 6	38,100	6	7147	○	○	○
1.3/4 - 5	44,450	5	7151	○	○	○
2 - 4.1/2	50,800	4.1/2	7155	○	○	○

Gwint amerykański rurowy stożkowy NPT 1:16, ANSI B-1.20.1					
Wymiar sprawdzianu według normy ANSI/ASME B1.20.1 Typ sprawdzianu GO - Przechodni NOGO - Nieprzechodni					
Symbol				MSXa	MSXc
Typ					
NPT Ø d ₁	1"/P	Tol			
		INDEX	S3-332100	Y3-432100	
1/16"	27	4621	○	○	
1/8"	27	4623	○	○	
1/4"	18	4627	○	○	
3/8"	18	4629	●	○	
1/2"	14	4631	●	○	
3/4"	14	4635	●	○	
1"	11.1/2	4639	●	○	
1.1/4"	11.1/2	4643	○	○	
1.1/2"	11.1/2	4647	○	○	
2"	11.1/2	4655	○	○	



Informacje techniczne odnośnie stosowania sprawdzianów NPT w części technicznej katalogu na str. 303

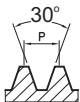
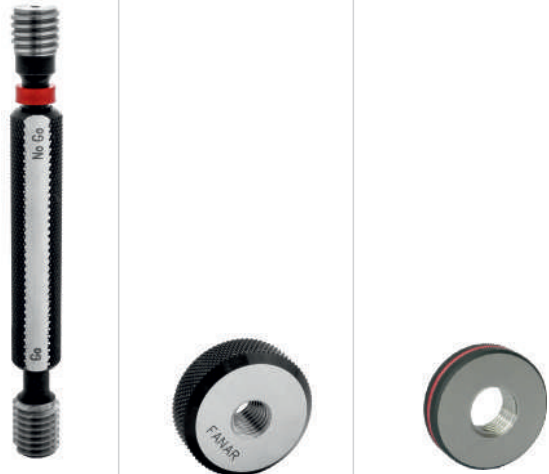

Gwint trapezowy Tr, DIN-103						
						
Wymiar sprawdzianu według normy DIN 103-9						
Typ sprawdzianu GO - Przechodni NOGO - Nieprzechodni						
Symbol				MSBg	MSRh	MSRk
Typ				GO / NOGO	GO	NOGO
Tr Ø d _i [mm]	P [mm]	ToI	7H	7e	7e	
			INDEX	S3-302171	Y3-412174	Y3-422174
Tr 10 x 2	2	8009	○	○	○	
Tr 12 x 3	3	8015	○	○	○	
Tr 14 x 3	3	8019	○	○	○	
Tr 16 x 4	4	8024	○	○	○	
Tr 18 x 4	4	8032	○	○	○	
Tr 20 x 4	4	8034	○	○	○	
Tr 22 x 5	5	8037	○	○	○	
Tr 24 x 5	5	8042	○	○	○	
Tr 26 x 5	5	8047	○	○	○	
Tr 28 x 5	5	8052	○	○	○	
Tr 30 x 6	6	8057	○	○	○	
Tr 32 x 6	6	8062	○	○	○	
Tr 36 x 6	6	8072	○	○	○	

OPRAWKI
MASZYNOWE



MS	Oprawki do gwintowania „SOFT SYNCHRO”	MASTERSYNC	232 - 233
OGK	Oprawki do gwintowania z kompensacją osiową		234 - 237
OGN	Oprawki do gwintowania z ruchem nawrotnym		238
FZS	Zabieraki ze sprzęgłem przeciążeniowym do gwintowników		239
FZ	Zabieraki bez sprzęgła przeciążeniowego do gwintowników		240
FZA	Adaptory szybkozmiennie do mocowania narzędzi w tulejkach ER		241
FR	Redukcje do zabieraków		241
ER	Tulejki zaciskowe do mocowania narzędzi trzpieniowych		242
ERC	Tulejki zaciskowe z zabierakiem kwadratowym do gwintowników		243
ERG	Tulejki zaciskowe z uszczelnieniem gumowym		244
ERCG	Tulejki zaciskowe z uszczelnieniem i zabierakiem kwadratowym do gwintowników		244
R	Uszczelki i nakrętki		245
TR	Tulejki redukcyjne do oprawek OGS		246
TRH	Tulejki redukcyjne TRH		247
RF	Tulejki elastyczne do oprawek OGN		248
C	Czopy do mocowania oprawek		249 - 250

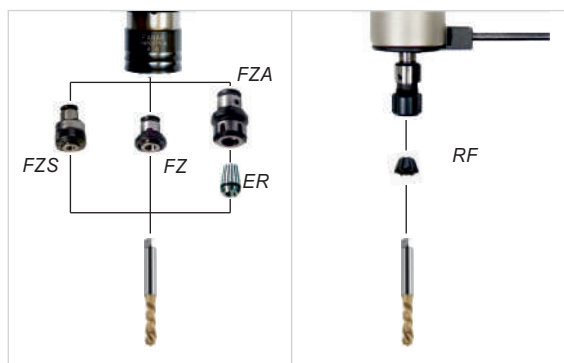
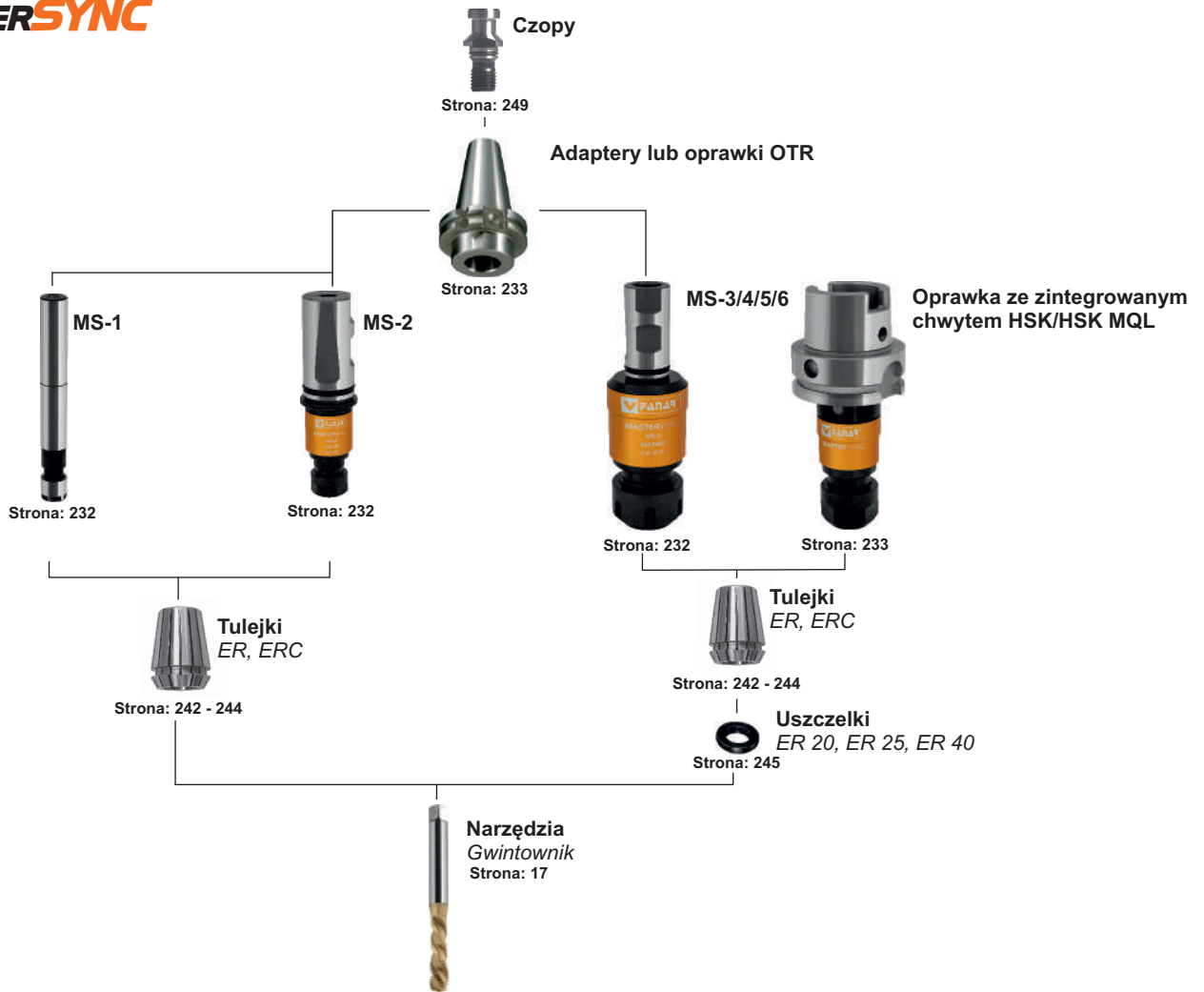

Strona	234 - 237	238
Opis	Do gwintowania z kompensacją osiową na ściskanie i rozciąganie	Do gwintowania z kompensacją osiową na ściskanie i rozciąganie oraz z ruchem nawrotnym do obrabiarek z prawymi obrotami wrzeciona

Chwył	Norma	Symbol	OGK	OGN
MORSE'A	DIN-228 A/B	MK	MK2, MK3, MK4, MK5	MK1, MK2, MK3, MK4 (JT6, M20)
DIN	DIN-2080	DIN	DIN30, DIN40, DIN50	
TR	DIN-6327	TR	TR20, TR28, TR36, TR48	
ISO	DIN 69871 A	ISO	ISO30, ISO40, ISO50	
MAS-BT	JIS B 6339	BT	BT30, BT40, BT50	
HSK	DIN 69893 A	HSK	HSK50, HSK63, HSK80, HSK100	
VDI	DIN 69880	VDI	VDI20, VDI25, VDI30, VDI40, VDI50	
WELDON	DIN 1835 B	W	W20, W25, W32, W40	
POLYGONAL	ISO 26623-1	C	C40, C50, C63, C80	

• Kompensacja osiowa: +/- 0,5

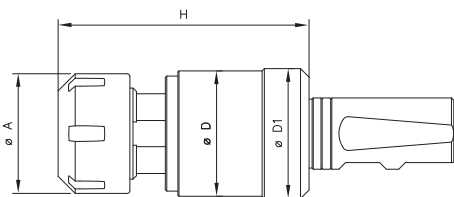

Akcesoria

MASTERSYNC

MS-1 MS-2 MS-3 MS-4 MS-5 MS-6



Zakres stosowania

M1+M3 M2+M5 M4,5+M12 M8+M20 M16+M30 M22+M48

Wewnętrzne chłodzenie

- - IK IK IK IK

Model	Chwył	Tulejka	M	D	D ₁	A	H	Uszczelki	INDEX						
MS-1-D12	12	ER8	M1+M3	12	12	12	28	-	R-MS-1-D12						
MS-2-W25	25	ER11	M2+M5	23,5	23,5	19	52	-		R-MS-2-W25					
MS-3-W25	25	ER20	M4,5+M12	34,6	36,3	34	69	+			R-MS-3-W25				
MS-4-W25	25	ER25	M8+M20	44	45,6	42	88	+				R-MS-4-W25			
MS-5-W25	25	ER40	M16+M30	62	63,6	63	117	+					R-MS-5-W25		
MS-6-W40	40	ER50	M22+M48	80	87	78	166	+						R-MS-6-W40	

• Kompensacja osiowa: +/- 0,5

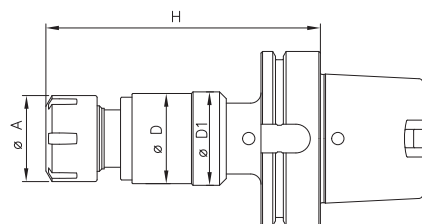

Akcesoria

MASTERSYNC

MS-3 MS-4 MS-5



Zakres stosowania

M4+M12 M8+M20 M16+M30

Wewnętrzne chłodzenie

IK IK IK

Model	Chwył	Tulejka	M	D	D ₁	A	H	Uszczelki	INDEX						
MS-3-HSK63A	HSK63A	ER20	M4+M12	34,6	36,3	34	108	+	R-MS-3-HSK63A						
MS-3-HSK80A	HSK80A	ER20	M4+M12	34,6	36,3	34	113	+	R-MS-3-HSK80A						
MS-3-HSK100A	HSK100A	ER20	M4+M12	34,6	36,3	34	115	+	R-MS-3-HSK100A						
MS-4-HSK63A	HSK63A	ER25	M8+M20	44	45,6	42	128	+			R-MS-4-HSK63A				
MS-4-HSK80A	HSK80A	ER25	M8+M20	44	45,6	42	115	+			R-MS-4-HSK80A				
MS-4-HSK100A	HSK100A	ER25	M8+M20	44	45,6	42	131	+			R-MS-4-HSK100A				
MS-5-HSK63A	HSK63A	ER40	M16+M30	62	63,6	63	160	+					R-MS-5-HSK63A		
MS-5-HSK80A	HSK80A	ER40	M16+M30	62	63,6	63	161	+					R-MS-5-HSK80A		
MS-5-HSK100A	HSK100A	ER40	M16+M30	62	63,6	63	163	+					R-MS-5-HSK100A		

Cechy i zalety										MASTER SYNC			
- zwiększa żywotność gwintownika o 100% lub więcej - poprawia jakość gwintu - precyzyjne dozowanie chłodziwa zwiększa żywotność gwintownika - redukuje koszty chłodziwa w procesie obróbki - przyjazne środowisku dzięki mniejszemu zużyciu chłodziwa - w standardzie jednokanałowe doprowadzenie chłodziwa - kompensacja osiowa: +/- 0,5										MS-3		MS-4	
Zakres stosowania										M4+M12		M8+M20	
Wewnętrzne chłodzenie										MQL		MQL	
Model	Chwyt	Tulejka	M	D	D ₁	A	H	Uszczelki	INDEX				
MS-3-HSK63A-MQL	HSK63A	ER20	M4+M12	34,6	36,6	34	108	+	R-MS-3-HSK63A-MQL				
MS-3-HSK80A-MQL	HSK80A	ER20	M4+M12	34,6	36,6	34	113	+	R-MS-3-HSK80A-MQL				
MS-3-HSK100A-MQL	HSK100A	ER20	M4+M12	34,6	36,6	34	115	+	R-MS-3-HSK100A-MQL				
MS-4-HSK63A-MQL	HSK63A	ER25	M8+M20	44	44	42	128	+	R-MS-4-HSK63A-MQL				
MS-4-HSK80A-MQL	HSK80A	ER25	M8+M20	44	44	42	131	+	R-MS-4-HSK80A-MQL				
MS-4-HSK100A-MQL	HSK100A	ER25	M8+M20	44	44	42	133	+	R-MS-4-HSK100A-MQL				

							ADAPTERY		OTR
Zakres stosowania									
Wewnętrzne chłodzenie									
Model	Chwyt	D	d	A	g	Norma	INDEX		
ISO40	ISO40	45	25	35	M16	DIN-69871	R-OTR-ISO40/D25		
ISO40	ISO40	90	40	120	M16	DIN-69871	R-OTR-ISO40/D40		
ISO50	ISO50	72	25	35	M24	DIN-69871	R-OTR-ISO50/D25		
ISO50	ISO50	90	40	100	M24	DIN-69871	R-OTR-ISO50/D40		
CAT40	CAT40	45	25	35	5/8"-11	CAT	R-OTR-CAT40/D25		
CAT50	CAT50	70	25	35	1"-8	CAT	R-OTR-CAT50/D25		
CAT50	CAT50	70	40	75	1"-8	CAT	R-OTR-CAT50/D40		
BT40	BT40	45	25	35	M16	DIN-B6339	R-OTR-BT40/D25		
BT50	BT50	70	25	48	M24	DIN-B6339	R-OTR-BT50/D25		
BT50	BT50	90	40	110	M24	DIN-B6339	R-OTR-BT50/D40		

									MK		MK-A										
Akcesoria <table border="1" style="width:100%; text-align:center;"> <tr> <td>Zabierak 188</td> <td>Adapter 191</td> <td>Tulejka 192</td> </tr> <tr> <td></td> <td></td> <td></td> </tr> <tr> <td>FZS</td> <td>FZA</td> <td>ER</td> </tr> </table>									Zabierak 188	Adapter 191	Tulejka 192				FZS	FZA	ER				
Zabierak 188	Adapter 191	Tulejka 192																			
FZS	FZA	ER																			
Norma									MORSE DIN-228 B		MORSE DIN-228 A										
Wewnętrzne chłodzenie																					
Chwyt	Zabierak	D	A	H	M	↔		INDEX		INDEX											
						(-)	(+)														
MK2	FZ19	19	38	46	M2-M12	9	9	R-OGK-MK2/FZ19	●												
MK3	FZ19	19	38	46	M2-M12	9	9	R-OGK-MK3/FZ19	●												
MK3	FZ31	31	55	69	M6-M20	15	15	R-OGK-MK3/FZ31	●												
MK4	FZ48	48	79	108	M14-M33	24	24	R-OGK-MK4/FZ48	●												
MK5	FZ60	60	98	116	M22-M48	26	26	R-OGK-MK5/FZ60	●												
MK2	FZ19	19	38	46	M2-M12	9	9			R-OGK-MK2/FZ19-A	○										
MK3	FZ19	19	38	46	M2-M12	9	9			R-OGK-MK3/FZ19-A	○										
MK3	FZ31	31	55	69	M6-M20	15	15			R-OGK-MK3/FZ31-A	○										
MK4	FZ48	48	79	108	M14-M33	24	24			R-OGK-MK4/FZ48-A	○										
MK5	FZ60	60	98	116	M22-M48	26	26			R-OGK-MK5/FZ60-A	○										
									DIN		TR										
Akcesoria <table border="1" style="width:100%; text-align:center;"> <tr> <td>Zabieraki 188</td> <td>Adaptory 191</td> <td>Tulejki 192</td> </tr> <tr> <td></td> <td></td> <td></td> </tr> <tr> <td>FZS</td> <td>FZA</td> <td>ER</td> </tr> </table>									Zabieraki 188	Adaptory 191	Tulejki 192				FZS	FZA	ER				
Zabieraki 188	Adaptory 191	Tulejki 192																			
FZS	FZA	ER																			
Norma									DIN-2080		DIN-6327										
Wewnętrzne chłodzenie																					
Chwyt	Zabierak	D	A	H	M	↔		INDEX		INDEX											
						(-)	(+)														
DIN30	FZ19	19	38	51	M2-M12	9	9	R-OGK-DIN30/FZ19	○												
DIN30	FZ31	31	55	86	M6-M20	15	15	R-OGK-DIN30/FZ31	○												
DIN40	FZ19	19	38	53	M2-M12	9	9	R-OGK-DIN40/FZ19	○												
DIN40	FZ31	31	55	77	M6-M20	15	15	R-OGK-DIN40/FZ31	○												
DIN40	FZ48	48	79	118	M14-M33	24	24	R-OGK-DIN40/FZ48	○												
DIN50	FZ19	19	38	57	M2-M12	9	9	R-OGK-DIN50/FZ19	○												
DIN50	FZ31	31	55	79	M6-M20	15	15	R-OGK-DIN50/FZ31	○												
DIN50	FZ48	48	79	125	M14-M33	24	24	R-OGK-DIN50/FZ48	○												
DIN50	FZ60	60	98	143	M22-M48	26	26	R-OGK-DIN50/FZ60	○												
TR20	FZ19	19	38	53	M2-M12	9	9			R-OGK-TR20/FZ19	○										
TR28	FZ19	19	38	53	M2-M12	9	9			R-OGK-TR28/FZ19	○										
TR28	FZ31	31	55	76	M6-M20	15	15			R-OGK-TR28/FZ31	○										
TR36	FZ19	19	38	55	M2-M12	9	9			R-OGK-TR36/FZ19	○										
TR36	FZ31	31	55	78	M6-M20	15	15			R-OGK-TR36/FZ31	○										
TR36	FZ48	48	79	111	M14-M33	24	24			R-OGK-TR36/FZ48	○										
TR36	FZ60	60	98	123	M22-M48	26	26			R-OGK-TR36/FZ60	○										
TR48	FZ48	48	79	115	M14-M33	24	24			R-OGK-TR48/FZ48	○										
TR48	FZ60	60	98	127	M22-M48	26	26			R-OGK-TR48/FZ60	○										

							ISO	MAS BT														
Akcesoria <table border="1" style="width: 100%; text-align: center;"> <tr> <td>Zabieraki 188</td> <td>Adaptory 190</td> <td>Tulejki 192</td> <td>Czopy 199 - 200</td> </tr> <tr> <td></td> <td></td> <td></td> <td></td> </tr> <tr> <td>FZS</td> <td>FZA</td> <td>ER</td> <td>C</td> </tr> </table>							Zabieraki 188	Adaptory 190	Tulejki 192	Czopy 199 - 200					FZS	FZA	ER	C				
Zabieraki 188	Adaptory 190	Tulejki 192	Czopy 199 - 200																			
FZS	FZA	ER	C																			
Norma							DIN-69871 A	JIS B6339														
Wewnętrzne chłodzenie																						
Chwył	Zabierak	D	A	H	M	↔		INDEX		INDEX												
						(-)	(+)															
ISO30	FZ19	19	38	60	M2-M12	9	9	R-OGK-ISO30/FZ19	○													
ISO30	FZ31	31	55	101	M6-M20	15	15	R-OGK-ISO30/FZ31	○													
ISO40	FZ19	19	38	60	M2-M12	9	9	R-OGK-ISO40/FZ19	●													
ISO40	FZ31	31	55	100	M6-M20	15	15	R-OGK-ISO40/FZ31	●													
ISO40	FZ48	48	79	138	M14-M33	24	24	R-OGK-ISO40/FZ48	○													
ISO40	FZ60	60	98	154	M22-M48	26	26	R-OGK-ISO40/FZ60	○													
ISO50	FZ19	19	38	62	M2-M12	9	9	R-OGK-ISO50/FZ19	○													
ISO50	FZ31	31	55	83	M6-M20	15	15	R-OGK-ISO50/FZ31	●													
ISO50	FZ48	48	79	133	M14-M33	24	24	R-OGK-ISO50/FZ48	●													
ISO50	FZ60	60	98	147	M22-M48	26	26	R-OGK-ISO50/FZ60	●													
BT30	FZ19	19	38	63	M2-M12	9	9			R-OGK-BT30/FZ19	○											
BT30	FZ31	31	55	96	M6-M20	15	15			R-OGK-BT30/FZ31	○											
BT40	FZ19	19	38	68	M2-M12	9	9			R-OGK-BT40/FZ19	●											
BT40	FZ31	31	55	93	M6-M20	15	15			R-OGK-BT40/FZ31	●											
BT40	FZ48	48	79	138	M14-M33	24	24			R-OGK-BT40/FZ48	○											
BT40	FZ60	60	98	157	M22-M48	26	26			R-OGK-BT40/FZ60	○											
BT50	FZ19	19	38	80	M2-M12	9	9			R-OGK-BT50/FZ19	○											
BT50	FZ31	31	55	102	M6-M20	15	15			R-OGK-BT50/FZ31	●											
BT50	FZ48	48	79	133	M14-M33	24	24			R-OGK-BT50/FZ48	○											
BT50	FZ60	60	98	147	M22-M48	26	26			R-OGK-BT50/FZ60	○											



Wersja OGK z wewnętrznym chłodzeniem na zapytanie

9



								HSK	VDI		
Akcesoria											
		Zabieraki 188	Adaptery 191	Tulejki 192							
		FZS	FZA	ER							
Norma								DIN-69893 A	DIN-69880		
Wewnętrzne chłodzenie											
Chwył	Zabierak	D	A	H	M	↔		INDEX		INDEX	
						(-)	(+)				
HSK50	FZ19	19	41	72	M2-M12	7,5	7,5	R-OGK-HSK50/FZ19	○		
HSK50	FZ31	31	60	110	M6-M20	10	10	R-OGK-HSK50/FZ31	○		
HSK63	FZ19	19	41	72	M2-M12	7,5	7,5	R-OGK-HSK63/FZ19	●		
HSK63	FZ31	31	60	110	M6-M20	10	10	R-OGK-HSK63/FZ31	●		
HSK63	FZ48	48	86	141	M14-M33	17,5	17,5	R-OGK-HSK63/FZ48	○		
HSK80	FZ19	19	41	75	M2-M12	7,5	7,5	R-OGK-HSK80/FZ19	○		
HSK80	FZ31	31	60	95	M6-M20	10	10	R-OGK-HSK80/FZ31	○		
HSK80	FZ48	48	86	141	M14-M33	17,5	17,5	R-OGK-HSK80/FZ48	○		
HSK100	FZ19	19	41	80	M2-M12	7,5	7,5	R-OGK-HSK100/FZ19	○		
HSK100	FZ31	31	60	100	M6-M20	10	10	R-OGK-HSK100/FZ31	○		
HSK100	FZ48	48	86	141	M14-M33	17,5	17,5	R-OGK-HSK100/FZ48	○		
VDI20	FZ19	19	38	55	M2-M12	9	9			R-OGK-VDI20/FZ19	○
VDI20	FZ31	31	55	77	M6-M20	15	15			R-OGK-VDI20/FZ31	○
VDI25	FZ19	19	38	55	M2-M12	9	9			R-OGK-VDI25/FZ19	●
VDI25	FZ31	31	55	77	M6-M20	15	15			R-OGK-VDI25/FZ31	●
VDI30	FZ19	19	38	55	M2-M12	9	9			R-OGK-VDI30/FZ19	●
VDI30	FZ31	31	55	77	M6-M20	15	15			R-OGK-VDI30/FZ31	●
VDI40	FZ19	19	38	55	M2-M12	9	9			R-OGK-VDI40/FZ19	○
VDI40	FZ31	31	55	77	M6-M20	15	15			R-OGK-VDI40/FZ31	●
VDI40	FZ48	48	79	110	M14-M33	24	24			R-OGK-VDI40/FZ48	○
VDI50	FZ48	48	79	110	M14-M33	24	24			R-OGK-VDI50/FZ48	○



Wersja OGKC z wewnętrznym chłodzeniem na zapytanie

								WELDON	POLYGONAL																														
Akcesoria <table border="1" style="width: 100%; text-align: center;"> <tr> <td>Zabieraki 188</td> <td>Adaptory 190</td> <td>Tulejki 192</td> <td colspan="5"></td> </tr> <tr> <td></td> <td></td> <td></td> <td colspan="5"></td> </tr> <tr> <td>FZS</td> <td>FZA</td> <td>ER</td> <td colspan="5"></td> </tr> </table>								Zabieraki 188	Adaptory 190	Tulejki 192														FZS	FZA	ER													
Zabieraki 188	Adaptory 190	Tulejki 192																																					
FZS	FZA	ER																																					
Norma								DIN-1835 B+E				ISO 26623-1																											
Wewnętrzne chłodzenie																																							
Chwyt	Zabierak	D	A	H	M	↔		INDEX		INDEX																													
						(-)	(+)																																
W20	FZ19	19	38	41	M2-M12	9	9	R-OGK-W20/FZ19	○																														
W20	FZ31	31	55	63	M6-M20	15	15	R-OGK-W20/FZ31	○																														
W25	FZ19	19	38	41	M2-M12	9	9	R-OGK-W25/FZ19	●																														
W25	FZ31	31	55	63	M6-M20	15	15	R-OGK-W25/FZ31	●																														
W32	FZ19	19	38	41	M2-M12	9	9	R-OGK-W32/FZ19	○																														
W32	FZ31	31	55	63	M6-M20	15	15	R-OGK-W32/FZ31	●																														
W32	FZ48	48	79	109	M14-M33	24	24	R-OGK-W32/FZ48	○																														
W40	FZ19	19	38	41	M2-M12	9	9	R-OGK-W40/FZ19	○																														
W40	FZ31	31	55	63	M6-M20	15	15	R-OGK-W40/FZ31	○																														
W40	FZ48	48	79	98	M14-M33	24	24	R-OGK-W40/FZ48	○																														
C40	FZ19	19	41	48	M2-M12	7,5	7,5			R-OGK-C40/FZ19	○																												
C40	FZ31	31	60	71	M6-M20	10	10			R-OGK-C40/FZ31	○																												
C50	FZ19	19	41	48	M2-M12	7,5	7,5			R-OGK-C50/FZ19	○																												
C50	FZ31	31	60	71	M6-M20	10	10			R-OGK-C50/FZ31	○																												
C63	FZ19	19	41	73	M2-M12	7,5	7,5			R-OGK-C63/FZ19	○																												
C63	FZ31	31	60	97	M6-M20	10	10			R-OGK-C63/FZ31	○																												
C63	FZ48	48	86	124	M12-M33	17,5	17,5			R-OGK-C63/FZ48	○																												
C80	FZ19	19	41	45	M2-M12	7,5	7,5			R-OGK-C80/FZ19	○																												
C80	FZ31	31	60	60	M6-M20	10	10			R-OGK-C80/FZ31	○																												
C80	FZ48	48	86	107	M12-M33	17,5	17,5			R-OGK-C80/FZ48	○																												



Wersja OGKC z wewnętrznym chłodzeniem na zapytanie

9



Informacje:

- Do obrabiarek z prawymi obrotami wrzeciona
 - Oprawka posiada kompensację osiową na ściskanie i rozciąganie oraz sprzęgło przeciążeniowe
- $I = U / U_n$
 U - prędkość gwintowania
 U_n - prędkość ruchu nawrotnego

Akcesoria



Norma

JT6 / M20 (+ MK DIN-228 B)

F	Tulejka	H	B	A	U _{max} [1/min]	I	M	W zestawie		INDEX	
								RF	TM		
JT6	RF15	134	55	23	1500	1,6	M2-M7	J116, J117	MK1, MK3	R-OGN-JT6/RF15-Z	●
JT6	RF23	158	75	28	1000	1,75	M5-M12	J421, J422	MK3, MK4	R-OGN-JT6/RF23-Z	●
M20	RF32	205	91	40	600	1,7	M5-M18	J441, J445	MK3, MK4	R-OGN-M20/RF32-Z	●



Oprawka sprzedawana jest w zestawie walizkowym wraz z akcesoriami - szczegóły w tabeli powyżej



Informacje:

- Zabieraki ze sprzęgłem przeciążeniowym przeznaczone są do opravek **OGK** posiadających kompensację osiową
- Sprzęgło przeciążeniowe pozwala uchronić narzędzie przed uszkodzeniem w przypadku dużego wzrostu oporów skrawania



Rozmiar					FZS13	FZS19	FZS31	FZS48	FZS60
d / A / H / h					13 / 23 / 21 / 6	19 / 32 / 25 / 8	31 / 50 / 34 / 4	48 / 72 / 45 / 1	60 / 95 / 68 / 3
M	DIN	D	∇	INDEX	R-FZS13	R-FZS19	R-FZS31	R-FZS48	R-FZS60
M 2	371	2,8	2,1	M2 D2,8 DIN	○	●			
M 3	371	3,5	2,7	M3 D3,5 DIN	○	●			
M 4	371	4,5	3,4	M4 D4,5 DIN	○	●			
M 5	371	6	4,9	M5 D6 DIN	○	●			
M 6	371	6	4,9	M6 D6 DIN	○	●	●		
M 8	371	8	6,2	M8 D8 DIN		●	●		
M 8	376	6	4,9	M8 D6 DIN		○	○		
M 10	371	10	8	M10 D10 DIN		●	●	○	
M 10	376	7	5,5	M10 D7 DIN		○	○		
M 12	376	9	7	M12 D9 DIN		●	●	○	
M 14	376	11	9	M14 D11 DIN		○	●	●	
M 16	376	12	9	M16 D12 DIN			●	○	
M 18	376	14	11	M18 D14 DIN			●	●	
M 20	376	16	12	M20 D16 DIN			●	○	○
M 22-M 24	376	18	14,5	M24 D18 DIN			●	●	○
M 27	376	20	16	M27 D20 DIN			○	●	○
M 30	376	22	18	M30 D22 DIN				○	○
M 33	376	25	20	M33 D25 DIN				○	○
M 36	376	28	22	M36 D28 DIN					●
M 39	376	32	24	M39 D32 DIN					○
M 42	376	32	24	M42 D32 DIN					●
M 45	376	36	29	M45 D36 DIN					○
M 48	376	36	29	M48 D36 DIN					○



Na zapytanie wersja wydłużona zabieraków o symbolu FZSL oraz przedłużeń FL



Zalecane wartości ustawienia momentów sprzęgieł na str. 312

Informacje:

- Zabieraki przeznaczone są do opravek OGK

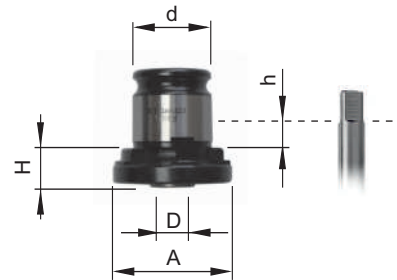

Rozmiar					FZ13	FZ19	FZ31	FZ48	FZ60
d / A / H / h					13 / 22 / 7 / 8	19 / 30 / 7 / 10	31 / 46 / 11 / 19	48 / 68 / 14 / 25	60 / 83 / 42 / 29
M	DIN	D	∅	INDEX	R-FZ13	R-FZ19	R-FZ31	R-FZ48	R-FZ60
M 2	371	2,8	2,1	M2 D2,8 DIN	○	○			
M 3	371	3,5	2,7	M3 D3,5 DIN	○	●			
M 4	371	4,5	3,4	M4 D4,5 DIN	○	●			
M 5, M6	371	6	4,9	M6 D6 DIN	○	●	●		
M 8	371	8	6,2	M8 D8 DIN		●	●		
M 10	371	10	8	M10 D10 DIN		●	●		
M 12	376	9	7	M12 D9 DIN		●	●		
M 14	376	11	9	M14 D11 DIN		○	○	○	
M 16	376	12	9	M16 D12 DIN			●	○	
M 18	376	14	11	M18 D14 DIN			○	○	
M 20	376	16	12	M20 D16 DIN			●	○	
M 22, M24	376	18	14,5	M24 D18 DIN			○	○	○
M 27	376	20	16	M27 D20 DIN				○	○
M 30	376	22	18	M30 D22 DIN				○	○
M 33	376	25	20	M33 D25 DIN				○	○
M 36	376	28	22	M36 D28 DIN					○
M 39, M42	376	32	24	M42 D32 DIN					○
M 45, M48	376	36	29	M48 D36 DIN					○



Na zapytanie wersja wydłużona zabieraków o symbolu FZL oraz przedłużek FL



Na zapytanie zabieraki FZN do narzynek



Informacje:

- Adaptory przeznaczone są do opravek OGK
- Mocowanie gwintowników w standardowych tulejkach ER - **adapter posiada wkręty zabierakowe**

*Po każdorazowej zmianie gwintownika konieczne jest dokręcenie zabieraków.



Akcesoria



Rozmiar	Tulejka	H	h	A	d	D	M	INDEX	
FZA19	ER16	29,5	8,5	28	19	2-10	M3-M12	R-FZA19/ER16	●
FZA31	ER25	38,5	15	42	31	2-16	M6-M20	R-FZA31/ER25	●

Redukcje do zabieraków

Informacje:

- Redukcje przeznaczone są do opravek OGK do podłączenia zabieraków FZS, FZ i adapterów FZA

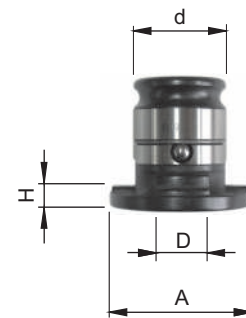

Redukcja	H	A	d	D	INDEX	
19/13	6	30	19	13	R-FR19/13	○
31/19	8,5	46	31	19	R-FR31/19	●
48/31	7	68	48	31	R-FR48/31	●
60/48	13	92	60	48	R-FR60/48	○



DIN-6499

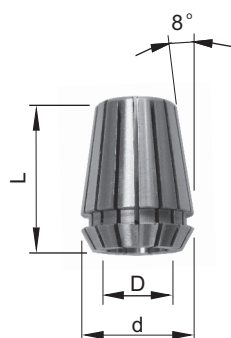

Rozmiar				ER16	ER20	ER25	ER32	ER40	ER50
d / L				17 / 27,5	21 / 31,5	26 / 34	33 / 40	41 / 46	52 / 60
D	M		INDEX	R-ER16	R-ER20	R-ER25	R-ER32	R-ER40	R-ER50
	DIN 371	DIN 376							
2			D2	●	●	●	●		
3	M2-M2,5	M3,5-M4	D3	●	●	●	●	○	
4	M3-M3,5	M5	D4	●	●	●	●	○	
5	M4	M6	D5	●	●	●	●	○	
6	M4,5-M5-M6	M8	D6	●	●	●	●	●	○
7	M7	M9-M10	D7	●	●	●	●	○	○
8	M8	M11	D8	●	●	●	●	●	○
9	M9	M12	D9	●	●	●	●	●	○
10	M10		D10	●	●	●	●	●	○
11		M14	D11		○	●	●	●	○
12		M16	D12		●	●	●	●	○
13		M16	D13		○	●	●	○	○
14		M18	D14			●	●	●	○
15		M18	D15			●	●	○	○
16		M20	D16			●	●	●	○
18		M22-M24	D18				●	●	○
20		M27	D20				●	●	○
22		M30	D22					●	○
25		M33	D25					●	○
28		M36	D28					●	○
32		M39-42	D32						○

9



Zestawy tulejek str. 261



DIN-6499

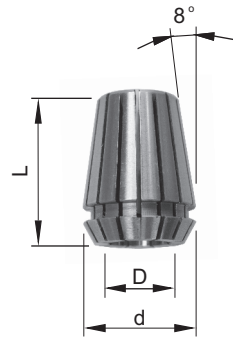

Rozmiar					ERC16	ERC20	ERC25	ERC32	ERC40	ERC50
d / L					17 / 27,5	21 / 31,5	26 / 34	33 / 40	41 / 46	52 / 60
D	∠	M		INDEX	R-ERC16	R-ERC20	R-ERC25	R-ERC32	R-ERC40	R-ERC50
		DIN 371	DIN 376							
3,5	2,7	M3	M4-M4,5	D3,5	○	○	●	○		
4,0	3,0	M3,5		D4	○	○	○	○		
4,5	3,4	M4	M6	D4,5	○	○	●	○		
5,0	4,0			D5	○	○	○	○		
5,5	4,3		M7	D5,5	○	○	○	○		
6,0	4,9	M4,5-M5-M6	M8	D6	●	●	●	●	○	
7,0	5,5	M7	M9-M10	D7	○	○	●	●	○	
8,0	6,2	M8	M11	D8	●	●	●	●	○	○
9,0	7,0	M9	M12	D9		○	●	●	○	○
10,0	8,0	M10		D10		●	●	●	○	○
11,0	9,0		M14	D11			○	●	○	○
12,0	9,0		M16	D12			●	●	●	○
14,0	11,0		M18	D14				●	○	○
16,0	12,0		M20	D16				●	●	○
18,0	14,5		M22-M24	D18					○	○
20,0	16,0		M27	D20					○	○
22,0	18,0		M30	D22						○
25,0	20,0		M33	D25						○
28,0	22,0		M36	D28						○
32,0	24,0		M39-42	D32						○



MAX
25 BAR

DIN-6499



Rozmiar				ERG16	ERG20	ERG25	ERG32	ERG40
d / L				17 / 27,5	21 / 31,5	26 / 34	33 / 40	41 / 46
D	M		INDEX	R-ERG16	R-ERG20	R-ERG25	R-ERG32	R-ERG40
	DIN 371	DIN 376						
3	M2-M2,5	M3,5-M4	D3	○	○	○	○	
4	M3-M3,5	M5	D4	○	○	○	○	○
5	M4	M6	D5	○	○	○	○	○
6	M4,5-M5-M6	M8	D6	○	○	●	●	○
7	M7	M9-M10	D7	○	○	○	○	○
8	M8	M11	D8	○	○	●	●	○
9	M9	M12	D9	○	○	○	○	○
10	M10		D10	○	○	●	●	○
11		M14	D11		○	○	○	○
12		M16	D12		○	●	●	○
13		M16	D13		○	○	○	○
14		M18	D14			●	●	○
15		M18	D15			○	○	○
16		M20	D16			●	●	○
18		M22-M24	D18				○	○
20		M27	D20				●	○
22		M30	D22					○
25		M33	D25					○

Tulejki zaciskowe z uszczelnieniem i zabierakiem kwadratowym do gwintowników

MAX
25 BAR

DIN-6499

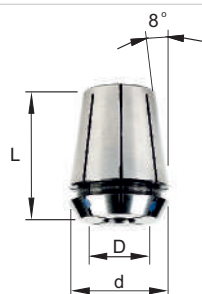

Rozmiar					ERCG16	ERCG20	ERCG25	ERCG32	ERCG40
d / L					17 / 27,5	21 / 31,5	26 / 34	33 / 40	41 / 46
D	∠	M		INDEX	R-ERCG16	R-ERCG20	R-ERCG25	R-ERCG32	R-ERCG40
		DIN 371	DIN 376						
4	3,0	M3,5		D4	○	○	●	○	
4,5	3,4	M4	M6	D4,5	○	○	○	○	
5	4			D5	○	○	●	○	
5,5	4,3		M7	D5,5	○	○	○	○	
6	4,9	M4,5-M5-M6	M8	D6	○	○	○	○	
7	5,5	M7	M9-M10	D7	●	●	●	●	○
8	6,2	M8	M11	D8	○	○	●	●	○
9	7	M9	M12	D9	●	●	●	●	○
10	8	M10		D10		○	●	●	○
11	9		M14	D11		●	●	●	○
12	9		M16	D12			○	●	○
14	11		M18	D14			●	●	●
16	12		M20	D16				●	○
18	14,5		M22-M24	D18				●	●
20	16			D20					○

Uszczelki



Uszczelki do ER40 i ER50 dostępne na zapytanie

Uszczelki do ER20	INDEX
3-3.5mm	R-U20/D3
3.5-4mm	R-U20/D3,5
4-4.5mm	R-U20/D4
4.5-5mm	R-U20/D4,5
5-5.5mm	R-U20/D5
5.5-6mm	R-U20/D5,5
6-6.5mm	R-U20/D6
6.5-7mm	R-U20/D6,5
7-7.5mm	R-U20/D7
7.5-8mm	R-U20/D7,5
8-8.5mm	R-U20/D8
8.5-9mm	R-U20/D8,5
9-9.5mm	R-U20/D9
9.5-10mm	R-U20/D9,5
10-10.5mm	R-U20/D10
10.5-11mm	R-U20/D10,5
11-11.5mm	R-U20/D11
11.5-12mm	R-U20/D11,5
12-12.5mm	R-U20/D12

Uszczelki do ER25	INDEX
3-3.5mm	R-U25/D3
3.5-4mm	R-U25/D3,5
4-4.5mm	R-U25/D4
4.5-5mm	R-U25/D4,5
5-5.5mm	R-U25/D5
5.5-6mm	R-U25/D5,5
6-6.5mm	R-U25/D6
6.5-7mm	R-U25/D6,5
7-7.5mm	R-U25/D7
7.5-8mm	R-U25/D7,5
8-8.5mm	R-U25/D8
8.5-9mm	R-U25/D8,5
9-9.5mm	R-U25/D9
9.5-10mm	R-U25/D9,5
10-10.5mm	R-U25/D10
10.5-11mm	R-U25/D10,5
11-11.5mm	R-U25/D11
11.5-12mm	R-U25/D11,5
12-12.5mm	R-U25/D12
12.5-13mm	R-U25/D12,5
13-13.5mm	R-U25/D13
13.5-14mm	R-U25/D13,5
14-14.5mm	R-U25/D14
14.5-15mm	R-U25/D14,5
15-15.5mm	R-U25/D15
15.5-16mm	R-U25/D15,5
16-16.5mm	R-U25/D16

Nakrętki mocujące wg. DIN 6499 bez uszczelnienia chłodziwa

Uwaga: Max. Nm pokazuje maksymalny moment jakim należy dokręcać nakrętkę

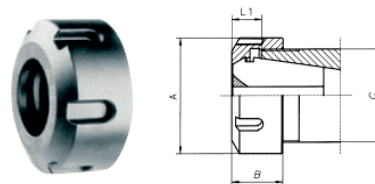

Typ	A mm	B mm	max. Nm	INDEX
ER11	19	11,3	30	R-NT11-SE
ER16	28	17,5	70	R-NT16-SE
ER20	34	19	100	R-NT20-SE

Typ	A mm	B mm	max. Nm	INDEX
ER25	42	20	130	R-NT25-S
ER40	63	25,5	220	R-NT40-S
ER50	78	35,3	300	R-NT50-S

9



Informacje:

- Zastosowanie tulejek redukcyjnych powoduje konieczność ograniczenia maksymalnej prędkości obrotowej do 50%

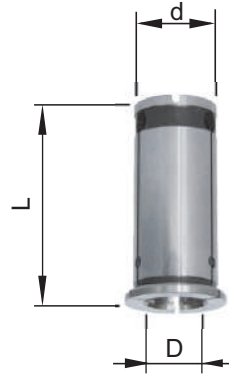

Rozmiar		TR20	TR32
d / L		20 / 54	32 / 64
D	INDEX	R-TR20	R-TR32
3	D3	○	○
4	D4	○	○
5	D5	○	○
6	D6	○	○
7	D7	○	○
8	D8	○	○
9	D9	○	○
10	D10	○	○
11	D11	○	○
12	D12	○	○
13	D13	○	○
14	D14	○	○
15	D15	○	○
16	D16	○	○
17	D17	○	○
18	D18	○	○
19	D19		○
20	D20		○
21	D21		○
22	D22		○
23	D23		○
24	D24		○
25	D25		○
26	D26		○
28	D28		○

Podstawowe akcesoria							TRH20	TRH20-EK
① Pierścień uszczelniający ② Regulowany zderzak do ustawiania długości								
Chłodzenie							-	EK kurtynowe
D ₁	D ₂	D ₃	l ₁	l ₂	m	INDEX	R-TRH20	R-TRH20-EK
3,0	20	24	50,5	2,0	0,1	D3	○	○
4,0	20	24	50,5	2,0	0,1	D4	○	○
5,0	20	24	50,5	2,0	0,1	D5	○	○
6,0	20	24	50,5	2,0	0,1	D6	○	○
7,0	20	24	50,5	2,0	0,1	D7	○	○
8,0	20	24	50,5	2,0	0,1	D8	○	○
9,0	20	24	50,5	2,0	0,1	D9	○	○
10,0	20	24	50,5	2,0	0,1	D10	○	○
11,0	20	24	50,5	2,0	0,1	D11	○	○
12,0	20	24	50,5	2,0	0,1	D12	○	○
13,0	20	24	50,5	2,0	0,1	D13	○	○
14,0	20	24	50,5	2,0	0,1	D14	○	○
15,0	20	24	50,5	2,0	0,1	D15	○	○
16,0	20	24	50,5	2,0	0,1	D16	○	○



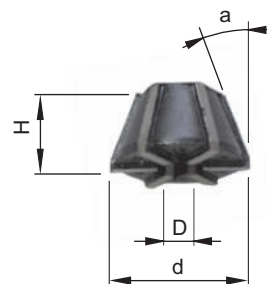

Rozmiar	d	H	a	D	M	INDEX	
RF15	15	12	13	2,5-4,5	M2-M4	R-RF15/J116	●
RF15	15	12	13	4,5-6,5	M4-M7	R-RF15/J117	●
RF23	23	13	20	3,5-6,5	M5-M6	R-RF23/J421	●
RF23	23	13	20	6,5-10,0	M6-M12	R-RF23/J422	●
RF32	32,5	16	22,5	4,5-10,0	M8-M12	R-RF32/J441	●
RF32	32,5	16	22,5	10,0-15,0	M10-M18	R-RF32/J445	●

Informacje:

- Zastosowanie: do opravek z chwytem ISO wg DIN-69871
- IK - wersja z otworem centralnym

C ISO A

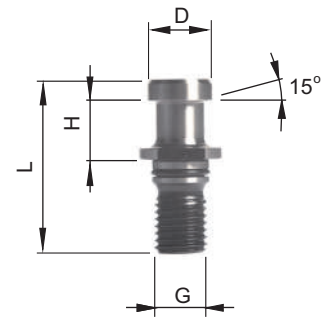

Norma

ISO-7388/2A

Rozmiar ISO	IK	O-RING	L	H	D	G	INDEX	
30			44	19	12	M12	R-C-ISO-A-30	○
30	●		44	19	12	M12	R-C-ISO-A-30-IK	○
40		●	54	20	19	M16	R-C-ISO-A-40	○
40	●	●	54	20	19	M16	R-C-ISO-A-40-IK	○
50		●	74	25	28	M24	R-C-ISO-A-50	○
50	●	●	74	25	28	M24	R-C-ISO-A-50-IK	○

Informacje:

- Zastosowanie: do opravek z chwytem ISO wg DIN-69871
- IK - wersja z otworem centralnym

C ISO B

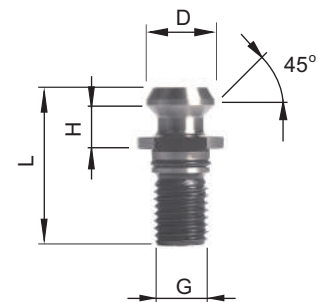

Norma

ISO-7388/2B

Rozmiar ISO	IK	O-RING	L	H	D	G	INDEX	
30			34,0	8,15	13,35	M12	R-C-ISO-B-30	○
30	●		34,0	8,15	13,35	M12	R-C-ISO-B-30-IK	○
40		●	44,5	11,15	18,95	M16	R-C-ISO-B-40	●
40	●	●	44,5	11,15	18,95	M16	R-C-ISO-B-40-IK	●
50		●	65,5	17,95	29,10	M24	R-C-ISO-B-50	○
50	●	●	65,5	17,95	29,10	M24	R-C-ISO-B-50-IK	○



Informacje:

- Zastosowanie: do opravek z chwytem ISO wg DIN-69871
- IK - wersja z otworem centralnym

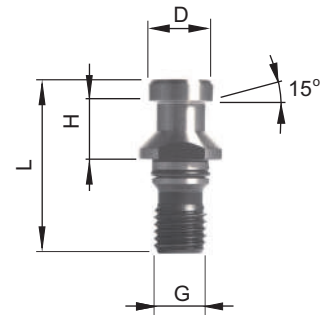
C DIN

Norma

DIN-69872

Rozmiar ISO	IK	O-RING	L	H	D	G	INDEX	
30			44	19	13	M12	R-C-DIN-30	○
30	●		44	19	13	M12	R-C-DIN-30-IK	○
40		●	54	20	19	M16	R-C-DIN-40	●
40	●	●	54	20	19	M16	R-C-DIN-40-IK	●
50		●	74	25	28	M24	R-C-DIN-50	○
50	●	●	74	25	28	M24	R-C-DIN-50-IK	○

Informacje:

- Zastosowanie: do opravek z chwytem MAS-BT
- IK - wersja z otworem centralnym

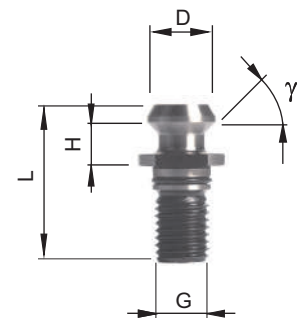
C BT

Rozmiar MAS-BT	IK	O-RING	L	H	D	G	γ	INDEX	
30			43	18	11	M12	45	R-C-BT-30/45	○
30	●		43	18	11	M12	45	R-C-BT-30/45-IK	○
30			43	18	11	M12	60	R-C-BT-30/60	○
30	●		43	18	11	M12	60	R-C-BT-30/60-IK	○
40		●	60	28	15	M16	45	R-C-BT-40/45	●
40	●	●	60	28	15	M16	45	R-C-BT-40/45-IK	●
40		●	60	28	15	M16	60	R-C-BT-40/60	○
40	●	●	60	28	15	M16	60	R-C-BT-40/60-IK	○
40		●	60	28	15	M16	90	R-C-BT-40/90	○
40	●	●	60	28	15	M16	90	R-C-BT-40/90-IK	○
50		●	85	35	23	M24	45	R-C-BT-50/45	○
50	●	●	85	35	23	M24	45	R-C-BT-50/45-IK	○
50		●	85	35	23	M24	60	R-C-BT-50/60	○
50	●	●	85	35	23	M24	60	R-C-BT-50/60-IK	○
50		●	85	35	23	M24	90	R-C-BT-50/90	○
50	●	●	85	35	23	M24	90	R-C-BT-50/90-IK	○

ZESTAWY NARZĘDZI



Zestawy do gwintowania ręcznego	253 - 256
Zestawy gwintowników maszynowych	257 - 259
Zestawy wiertel HSSE	259
Zestawy pogłębiaczy stożkowych	260
Zestaw wiertel do usuwania złamanych gwintowników	260
Zestawy frezów trzpieniowych	261
Zestawy tulejek mocujących	261 - 262
Zestaw sprawdzianów do gwintów	262 - 263

CZD-40 HSS M3÷M20
INDEX Z1-040011-0000

	Gwintowniki	Narzynki	Wzorec zarysu gwintu	Pokrętki do gwintowników	Oprawki do narzynek	Wkrętak
ZAWARTOŚĆ	DIN-352 HSS dla M3÷M12 DIN-352/2 HSS dla M14÷M20	DIN-EN 22 568 HSS 800	MWGa	PBPc	PBGa	RWWe
	M3 M4 M5 M6 M7, M8, M10 M12 M14 M16 M20	Ø25 x 9: M3 M4 M5 M6 M7 M8 M10 Ø38 x 14: M12 M14 M16 M20	0,4 + 6 mm	Nr 2 zm.: 2,5 + 9 mm Nr 3: 4,9 + 14 mm	Ø25 x 9 mm Ø38 x 14 mm	4 x 90 mm
WYMIARY	475 x 255 x 40 mm					
CIĘŻAR	3,4 kg					



CZD-85 HSS M3÷M24
INDEX Z1-085011-0000

	Gwintowniki	Narzynki	Wzorec zarysu gwintu	Pokrętki do gwintowników	Oprawki do narzynek	Pokrętka typu "T"	Wkrętak	Pierścieni dystansowy
ZAWARTOŚĆ	DIN-352 HSS - M3÷M12 DIN-352/2 HSS - M14÷M24 DIN-2181/2 HSS - MF≥14x1,25	DIN-EN 22 568 HSS 800	MWGa	PBPc	PBGa		RWWe	
	M3, M4, M5, M6, M8, M10, M12, M14, M16, M18, M20, M22, M24, M8x1, M10x1, M12x1,25, M12x1,5, M14x1,25, M14x1,5, M16x1,5, M18x1,5, M20x1,5, M22x1,5, M24x1,5	M3 M4 M5 M6 M8 M10 M12 M14 M16 M18 M20 M22 M24 M8x1 M10x1 M12x1,25 M12x1,5 M14x1,25 M14x1,5 M16x1,5 M18x1,5 M20x1,5 M22x1,5 M24x1,5	0,4 + 6 mm	Nr 2 zm.: 2,5 + 9 mm Nr 3: 4,9 + 14 mm	Ø25 x 9 mm Ø38 x 14 mm Ø45 x 18 mm Ø55 x 22 mm	Nr 1 (M2 + M5)	4 x 90 mm	38 x 2 45 x 2 55 x 3
WYMIARY	550 x 380 x 70 mm							
CIĘŻAR	12 kg							



10



CZB-29 HSS M3÷M12
INDEX Z1-029012-0000

ZAWARTOŚĆ	Gwintowniki	Narzynki
	DIN-352/3 HSS	DIN-EN 22 568 HSS 800
		
M3 M4 M5 M6 M8 M10 M12	Ø25 x 9: M3 M4 M5 M6 M8 M10 M12	
WYMIARY	270 x 230 x 30 mm	
CIEŻAR	0,9 kg	

CZB-29W HSS M3÷M12
INDEX Z1-029112-0000

ZAWARTOŚĆ	Gwintowniki	Narzynki	Wiertła
	DIN-352/2 HSS	DIN-EN 22 568 HSS 800	DIN-338 N HSS
			
M3, M4, M5, M6, M8, M10, M12	Ø25 x 9: M3, M4, M5, M6, M8, M10, M12	Ø2,5; Ø3,3; Ø4,2; Ø5,0; Ø6,8; Ø8,5; Ø10,2	
WYMIARY	340 x 290 x 40 mm		
CIEŻAR	1,2 kg		

10

CZB-31 HSS M3÷M12
INDEX Z1-031012-0000





ZAWARTOŚĆ	Gwintowniki	Narzynki	Pokrętka do gwintowników	Oprawka do narzynek	Wkrętak
	DIN-352/3 HSS	DIN-EN 22 568 HSS 800	PBPc	PBGa	RWWe
M3 M4 M5 M6 M8 M10 M12	Ø25 x 9: M3 M4 M5 M6 M8 M10 M12	Nr 1,5: 2,5 + 8 mm	Ø25 x 9 mm	4 x 90 mm	
WYMIARY	340 x 290 x 40 mm				
CIEŻAR	1,6 kg				

CZB-31 INOX M3÷M12
INDEX Z2-031012-0000

ZAWARTOŚĆ	Gwintowniki	Narzynki	Pokrętka do gwintowników	Oprawka do narzynek	Wkrętak
	DIN-352/3 HSSE INOX	DIN-EN 22 568 HSSE INOX	PBPc	PBGa	RWWe
M3 M4 M5 M6 M8 M10 M12	Ø25 x 9: M3 M4 M5 M6 M8 M10 M12	Nr 1,5: 2,5 + 8 mm	Ø25 x 9 mm	4 x 90 mm	
WYMIARY	340 x 290 x 40 mm				
CIEŻAR	1,6 kg				



10

CZP-31 HSS mini M1÷M2,5
INDEX Z1-031115-0000





ZAWARTOŚĆ	Gwintowniki	Narzynki	Pokrętka do gwintowników i narzynek
	DIN-352/2 HSS	DIN-EN 22 568 HSS	
			
	M1 M1,1 M1,2 M1,4 M1,6 M1,8 M2 M2,2 M2,5	Ø12 x 3: M1 M1,1 M1,2 M1,4 M1,6 M1,8 M2, Ø16 x 3: M2,2 M2,5	
WYMIARY	155 x 85 x 12 mm		
CIĘŻAR	0,2 kg		





CZP-7 BIT HSS M3÷M10
Z1-007020-0310

Oznaczenie	M Ød ₁	⬡	INDEX	Z1-007020
CZP-7 BIT HSS	M 3 ÷ M 10	1/4"	0310	•

CZP-8 MasterTAP R45 HSSE-PM HL	CZP-8 MasterTAP B HSSE-PM HL
INDEX Z4-528M15-0310	INDEX Z4-118M15-0310
	
ZAWARTOŚĆ	
Gwintowniki	
MasterTAP 6HX DIN-371 C R45 HSSE-PM HL	MasterTAP 6HX DIN-371 B HSSE-PM HL
 <p style="text-align: center;">M3 M4 M5 M6 M8 M10</p>	 <p style="text-align: center;">M3 M4 M5 M6 M8 M10</p>
Wymiary opakowania 155 x 145 x 32 mm	Ciężar 0,2 kg
CZP-8 800X C R40 HSSE TN2	CZP-8 800X B HSSE TN2
INDEX Z2-513X15-0310	INDEX Z2-113X15-0310
	
ZAWARTOŚĆ	
Gwintowniki	
800X 6H DIN-371 C R40 HSSE TN2	800X 6H DIN-371 B HSSE TN2
 <p style="text-align: center;">M3 M4 M5 M6 M8 M10</p>	 <p style="text-align: center;">M3 M4 M5 M6 M8 M10</p>
800X 6H DIN-376 C R40 HSSE TN2	800X 6H DIN-376 B HSSE TN2
 <p style="text-align: center;">M12</p>	 <p style="text-align: center;">M12</p>
Wymiary opakowania 145 x 90 x 37 mm	Ciężar 0,2 kg



CZP-5 800X C R40 HSSE TN2	CZP-5 800X B HSSE TN2
INDEX Z2-X53520-0408	INDEX Z2-X53120-0408
	
ZAWARTOŚĆ	
Gwintowniki	
800X 6H DIN-371 C R40 HSSE TN2	800X 6H DIN-371 B HSSE TN2
 <p data-bbox="379 913 555 936">M4 M5 M6 M8</p>	 <p data-bbox="1034 913 1209 936">M4 M5 M6 M8</p>
Wymiary opakowania 120 x 80 x 45 mm	Ciężar 0,1 kg









CZP-5 R40 HSSE	CZP-5 B HSSE
INDEX Z2-055115-0408	INDEX Z2-051115-0408
	
ZAWARTOŚĆ	
Gwintowniki	
DIN-371-C ISO2(6H) R40 HSSE 800	DIN-371-B ISO2(6H) HSSE 800
 <p data-bbox="379 1881 555 1904">M4 M5 M6 M8</p>	 <p data-bbox="1034 1881 1209 1904">M4 M5 M6 M8</p>
Wymiary opakowania 120 x 80 x 45 mm	Ciężar 0,1 kg

CZP-8 B HSSE OPTI OX	CZP-8 R40 HSSE OPTI OX	CZP-8 C HSSE OPTI OX
INDEX Z2-081015-0000	INDEX Z2-085015-0000	INDEX Z2-082015-0000
ZAWARTOŚĆ		
Gwintowniki		
DIN-371 B ISO2 (6H) HSSE OPTI OX	DIN-371 C ISO2 (6H) R40 HSSE OPTI OX	DIN-371 C ISO2 (6H) C HSSE OPTI OX
<p>M3 M4 M5 M6 M8 M10</p>	<p>M3 M4 M5 M6 M8 M10</p>	<p>M3 M4 M5 M6 M8 M10</p>
DIN-376 B ISO2 (6H) HSSE OPTI OX	DIN-376 C ISO2 (6H) R40 HSSE OPTI OX	DIN-376 C ISO2 (6H) C HSSE OPTI OX
<p>M12</p>	<p>M12</p>	<p>M12</p>
Wymiary opakowania 145 x 90 x 37 mm		Ciężar 0,2 kg

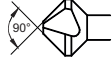
CZW-19 HSSE INOX TiN Ø1,0 ÷ Ø10	CZW-24 HSSE INOX TiN Ø1,0 ÷ Ø10,5	CZW-25 HSSE INOX TiN Ø1,0 ÷ Ø13
INDEX Z2-019315-0000	INDEX Z2-024315-0000	INDEX Z2-025315-0000
ZAWARTOŚĆ		
Wiertła stalowe		
WYMIARY		
1 1,5 2 2,5 3 3,5 4 4,5 5 5,5 6 6,5 7 7,5 8 8,5 9 9,5 10	1 1,5 2 2,5 3 3,5 4 4,5 5 5,5 6 6,5 7 7,5 8 8,5 9 9,5 10 + wymiary pod gwint 3,3 4,2 6,8 10,2 10,5	1 1,5 2 2,5 3 3,5 4 4,5 5 5,5 6 6,5 7 7,5 8 8,5 9 9,5 10 10,5 11 11,5 12 12,5 13

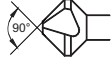
10



CZP-6 DIN-335-C Master-line Ø6,3÷Ø25 HSSE TC	CZP-6 DIN-335-C X-line Ø6,3÷Ø25 HSSE TN2	CZP-6 DIN-335-C Ø6,3÷Ø25 HSSE
INDEX Z2-065015-0000	INDEX Z2-065X15-0000	INDEX Z2-065S15-0000
		
		
ZAWARTOŚĆ		
Pogłębiacze		
DIN-335-C HSSE TC	DIN-335-C HSSE TN2	DIN-335-C HSSE
		
6,3 10,4 16,5 20,5 25	6,3 10,4 16,5 20,5 25	6,3 10,4 16,5 20,5 25
Wymiary opakowania 145 x 100 x 42 mm		Ciężar 0,3 kg

WDG M3÷M12
INDEX W9-900002-0000

Wiertła do złamanych gwintowników

WDG

ZAWARTOŚĆ

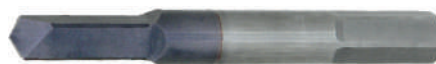

M3 | M4 | M5 | M6 | M8 | M10 | M12

WYMIARY

290 x 340 x 40 mm

CIĘŻAR

1,2 kg

10

MasterMill 440N 6-12 VHM TS	X-MILL 440N 6-12 VHM AT
INDEX Z9-44GMA0-0612	INDEX Z9-444XA0-0612
 	
ZAWARTOŚĆ	
Frezy	
MasterMill 440N VHM TS	X-MILL 440N VHM AT
 	
6 8 10 12	
Wymiary opakowania	Ciężar
155 x 145 x 32 mm	0,4 kg

R-ER11	R-ER16	R-ER20
INDEX: R-ER11-13BOX	INDEX: R-ER16-10BOX	INDEX: R-ER20-12BOX
		
Tulejki		
Plastikowe pudełko D.1÷7 x 0,5 mm	Plastikowe pudełko D.1÷10 x 1 mm	Plastikowe pudełko D.2÷13 x 1 mm

10



R-ER25	R-ER32	R-ER40
INDEX: R-ER25-15BOX	INDEX: R-ER32-18BOX	INDEX: R-ER40-23BOX
Tulejki		
Aluminiowe pudełko D.2÷16 x 1 mm	Aluminiowe pudełko D.3÷20 x 1 mm	Aluminiowe pudełko D.4÷26 x 1 mm

CZD-8 MSRh M3÷M12
Index: Z3-200120-0312

Wymiar sprawdzianu według normy ISO 1502

Zestaw sprawdzianów

ZAWARTOŚĆ	MSRh 6g
	M3 M4 M5 M6 M8 M10 M12
WYMIARY	145 x 145 x 35 mm
CIĘŻAR	0,5 kg

10

CZD-8 MSBg M3÷M12
Index: Z3-302161-0312

Wymiar sprawdzianu według normy ISO 1502

Zestaw sprawdzianów

MSBg 6H

ZAWARTOŚĆ



M3 | M4 | M5 | M6 | M8 | M10 | M12

WYMIARY

290 x 175 x 35 mm

CIĘŻAR

0,6 kg

10



AKCESORIA I MASZyny DO GWINTOWANIA

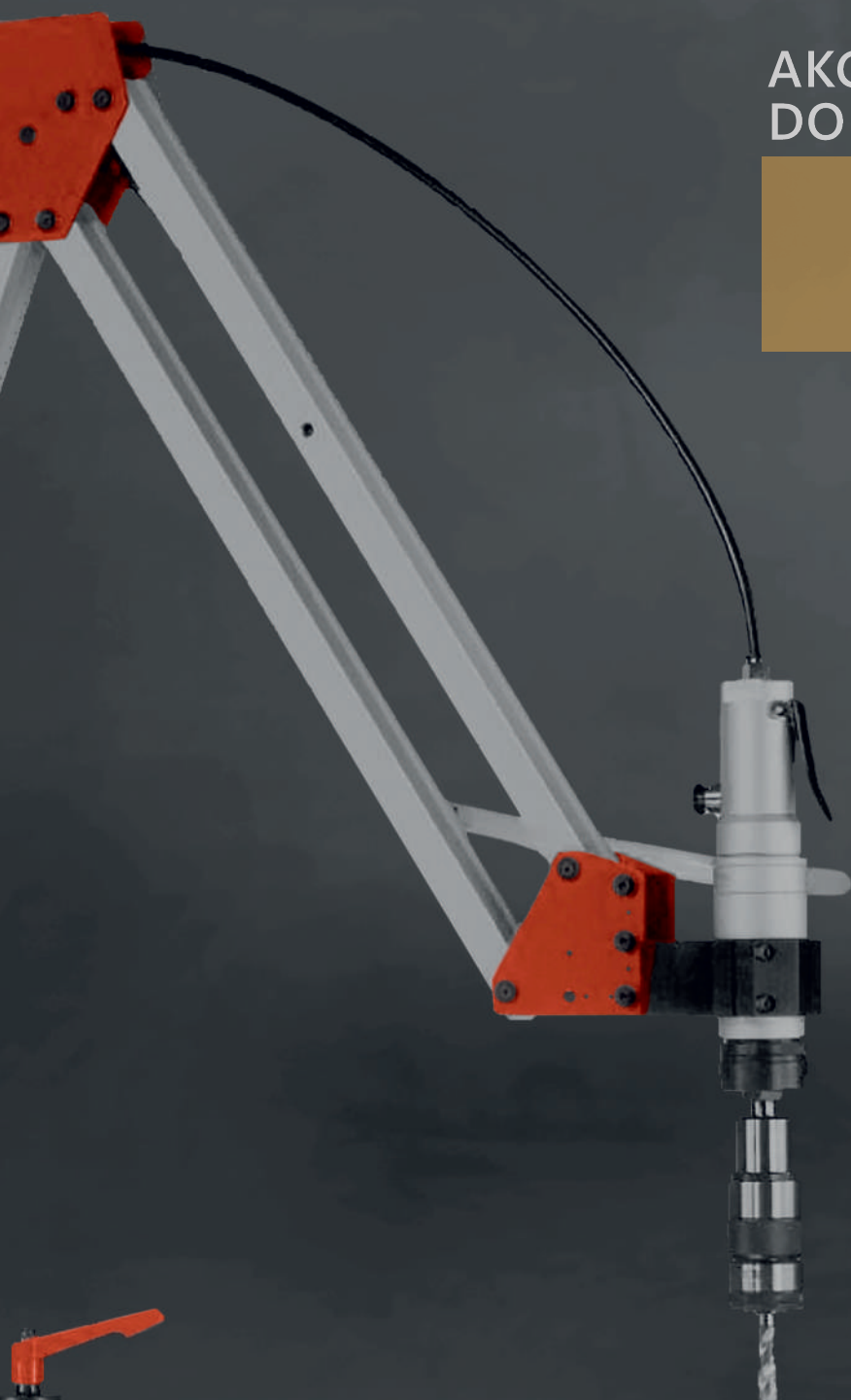

Środki ułatwiające gwintowanie	267
Pokrętki, przedłużacze, oprawki	268
Przedłużacze maszynowe do gwintowników	269 - 271
Pneumatyczne maszyny do gwintowania	272 - 273
Ostrzarki PMW do wiertel	274

TEREBOR

Preparat do gwintowania

Zastosowanie: do gwintowania stali trudnoobrabialnych, a w szczególności:

- stali nierdzewne,
- stali kwasoodporne,
- stali o podwyższonej wytrzymałości na rozciąganie



POJEMNOŚĆ	INDEX
250 ml	T0-100110-0250
500 ml	T0-100110-0500
5 l	T0-100110-5000

VARIOCUT B 40

Bezchlorowy olej do obróbki skrawaniem

Zastosowanie: do gwintowania stali węglowych i niskostopowych



POJEMNOŚĆ	INDEX
250 ml	T0-100340-0250
500 ml	T0-100340-0500
5 l	T0-100340-5000
200 l*	Na zapytanie

*Do zastosowania w automatach tokarskich

CIMTAP

Pasta do gwintowania

Zastosowanie: do gwintowania ręcznego i maszynowego metali żelaznych i nieżelaznych



POJEMNOŚĆ	INDEX
1 l	T0-100410-1000

Pokrętki do gwintowników

Oznaczenie	□	l	M		INDEX
			ISO-529	DIN-352	
PBPc/m - 0	2 ± 4,5	125	M1 ± M5	M1 ± M4	V0-303000-0204
PBPc/m - 1	3,15 ± 6,3	205	M4 ± M8	M3 ± M11	V0-303010-0306
PBPc/m - 1,5	2,5 ± 7,1	205	M3 ± M9	M3 ± M12	V0-303015-0207
PBPc/m - 2	3,55 ± 9	305	M4,5 ± M14	M4,5 ± M16	V0-303020-0309
PBPc/m - 4	5,6 ± 16	395	M7 ± M27	M11 ± M27	V0-303040-0516
PBPc/m - 5	7 ± 20	700	M9 ± M30	M13 ± M32	V0-303050-0720

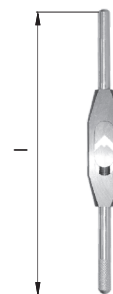
Pokrętki typu "t" do gwintowników

Oznaczenie	□	l	M		INDEX
			ISO-529	DIN-352	
PT Nr 1	2,0 ± 4,0	55	M1 ± M5	M1 ± M4	V0-310000-0205
PT Nr 1D	2,0 ± 4,0	200	M1 ± M5	M1 ± M4	V0-311000-0205
PT Nr 2	4,0 ± 7,1	90	M6 ± M12	M5 ± M12	V0-320000-0612
PT Nr 2D	4,0 ± 7,1	250	M6 ± M12	M5 ± M12	V0-321000-0612
PT Nr 3	9,0 ± 11,2	110	M14 ± M20	M14 ± M18	V0-330000-1420

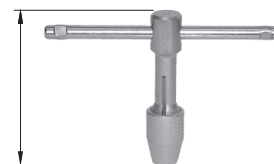
Pokrętki z grzechotką do gwintowników

Oznaczenie	l	M DIN-352	INDEX
PG Nr 1	85	M3 ± M6	V0-310500-0306
PG Nr 1 D	250	M3 ± M6	V0-311500-0306
PG Nr 2	110	M6 ± M12	V0-320500-0612
PG Nr 2 D	300	M6 ± M12	V0-321500-0612

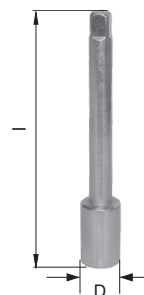

Przedłużacze do gwintowników

Oznaczenie	□	l	D	M		INDEX
				ISO-529	DIN-352	
PBNa - 5	5,0	110	11	M6		V0-200000-0050
PBNa - 6,3	6,3	120	14	M8, M11		V0-200000-0063
PBNa - 7,1	7,1	125	15	M9, M12		V0-200000-0071
PBNa - 8	8,0	130	17	M10		V0-200000-0080
PBNa - 9	9,0	130	19	M14	M14, M16	V0-200000-0090
PBNa - 10	10,0	140	21	M16		V0-200000-0100

Oprawki do narzynek

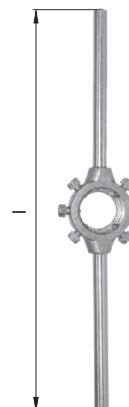
Oznaczenie	l	M	INDEX
PBGa/m - 16x5	160	M1 ± M2,5	V0-103000-1605
PBGa/m - 20x5	185	M3 ± M6	V0-103000-2005
PBGa/m - 25x9	220	M7 ± M9	V0-103000-2509
PBGa/m - 30x11	260	M10 ± M11	V0-103000-3011
PBGa/m - 38x14	310	M12 ± M14	V0-103000-3814
PBGa/m - 45x18	400	M16 ± M20	V0-103000-4518
PBGa/m - 55x22	500	M22 ± M24	V0-103000-5522
PBGa/m - 65x25	560	M27 ± M36	V0-103000-6525

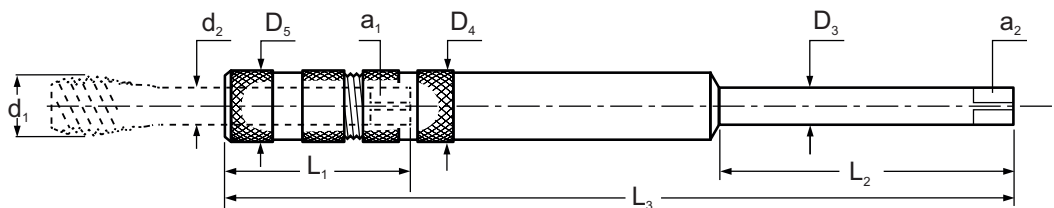



Krótkie

Oznaczenie	d ₁		d ₂	D ₃	D ₄ =D ₅	L ₁	L ₂	L ₃	a ₁	a ₂	INDEX
	DIN-371	DIN-376									
PBNm 2,8/2,1-6/4,9-130	M2 - M2,6	M4	2,8	6	6,1	22	60	130	2,1	4,9	V0-211130-0206
PBNm 3,5/2,7-6/4,9-130	M3	M4,5 - M5	3,5	6	7,5	23	60	130	2,7	4,9	V0-211130-0306
PBNm 4,5/3,4-6/4,9-130	M4	M6	4,5	6	8,4	23	60	130	3,4	4,9	V0-211130-0406
PBNm 6/4,9-7/5,5-130	M4,5 - M6	M8	6	7	12,1	26	60	130	4,9	5,5	V0-211130-0607
PBNm 7/5,5-7/5,5-130	M7	M9 - M10	7	7	12,1	26	60	130	5,5	5,5	V0-211130-0707
PBNm 8/6,2-8/6,2-130	M8	M11	8	8	13	30	60	130	6,2	6,2	V0-211130-0808
PBNm 9/7-9/7-130	M9	M12	9	9	15	31	60	130	7	7	V0-211130-0909
PBNm 10/8-10/8-130	M10	-	10	10	15	33	60	130	8	8	V0-211130-1010
PBNm 11/9-11/9-130		M14	11	11	18	36	90	130	9	9	V0-211130-1111
PBNm 12/9-12/9-130		M16	12	12	18	36	90	130	9	9	V0-211130-1212
PBNm 14/11-14/11-200		M18	14	14	22	42	90	200	11	11	V0-211200-1414
PBNm 16/12-16/12-200		M20	16	16	22	42	90	200	12	12	V0-211200-1616
PBNm 18/14,5-18/14,5-200		M22/M24	18	18	26	43	100	200	14,5	14,5	V0-211200-1818
PBNm 20/16-20/16-200		M27	20	20	28	48	100	200	16	16	V0-211200-2020

Długie

Oznaczenie	d ₁		d ₂	D ₃	D ₄ =D ₅	L ₁	L ₂	L ₃	a ₁	a ₂	INDEX
	DIN-371	DIN-376									
PBNm 2,8/2,1-6/4,9-230	M2-M2,6	M4	2,8	6	6,1	22	70	230	2,1	4,9	V0-211230-0206
PBNm 3,5/2,7-6/4,9-230	M3	M4,5-M5	3,5	6	7,5	23	70	230	2,7	4,9	V0-211230-0306
PBNm 4,5/3,4-6/4,9-230	M4	M6	4,5	6	8,4	23	70	230	3,4	4,9	V0-211230-0406
PBNm 6/4,9-7/5,5-230	M4,5 - M6	M8	6	7	12,1	26	70	230	4,9	5,5	V0-211230-0607
PBNm 7/5,5-7/5,5-230	M7	M9 - M10	7	7	12,1	26	70	230	5,5	5,5	V0-211230-0707
PBNm 8/6,2-8/6,2-230	M8	M11	8	8	13	30	80	230	6,2	6,2	V0-211230-0808
PBNm 9/7-9/7-230	M9	M12	9	9	15	31	80	230	7	7	V0-211230-0909
PBNm 10/8-10/8-230	M10	-	10	10	15	33	80	230	8	8	V0-211230-1010
PBNm 11/9-11/9-230		M14	11	11	18	36	90	230	9	9	V0-211230-1111
PBNm 12/9-12/9-230		M16	12	12	18	36	90	230	9	9	V0-211230-1212
PBNm 14/11-14/11-330		M18	14	14	22	42	90	330	11	11	V0-211330-1414
PBNm 16/12-16/12-330		M20	16	16	22	42	90	330	12	12	V0-211330-1616
PBNm 18/14,5-18/14,5-330		M22/M24	18	18	26	43	100	330	14,5	14,5	V0-211330-1818
PBNm 20/16-20/16-330		M27	20	20	28	48	100	330	16	16	V0-211330-2020

IK

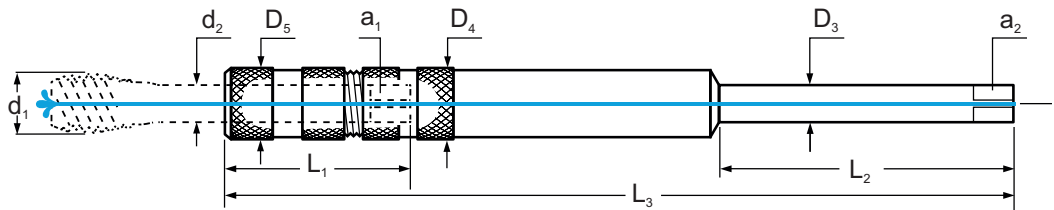

Krótkie

Oznaczenie	d_1		d_2	D_3	$D_4=D_5$	L_1	L_2	L_3	a_1	a_2	INDEX
	DIN-371	DIN-376									
PBNm 2,8/2,1-6/4,9-130	M2 - M2,6	M4	2,8	6	6,1	22	60	130	2,1	4,9	V0-211135-0206
PBNm 3,5/2,7-6/4,9-130	M3	M4,5 - M5	3,5	6	7,5	23	60	130	2,7	4,9	V0-211135-0306
PBNm 4,5/3,4-6/4,9-130	M4	M6	4,5	6	8,4	23	60	130	3,4	4,9	V0-211135-0406
PBNm 6/4,9-7/5,5-130	M4,5 - M6	M8	6	7	12,1	26	60	130	4,9	5,5	V0-211135-0607
PBNm 7/5,5-7/5,5-130	M7	M9 - M10	7	7	12,1	26	60	130	5,5	5,5	V0-211135-0707
PBNm 8/6,2-8/6,2-130	M8	M11	8	8	13	30	60	130	6,2	6,2	V0-211135-0808
PBNm 9/7-9/7-130	M9	M12	9	9	15	31	60	130	7	7	V0-211135-0909
PBNm 10/8-10/8-130	M10	-	10	10	15	33	60	130	8	8	V0-211135-1010
PBNm 11/9-11/9-130	-	M14	11	11	18	36	90	130	9	9	V0-211135-1111
PBNm 12/9-12/9-130	-	M16	12	12	18	36	90	130	9	9	V0-211135-1212
PBNm 14/11-14/11-200	-	M18	14	14	22	42	90	200	11	11	V0-211205-1414
PBNm 16/12-16/12-200	-	M20	16	16	22	42	90	200	12	12	V0-211205-1616
PBNm 18/14,5-18/14,5-200	-	M22/M24	18	18	26	43	100	200	14,5	14,5	V0-211205-1818
PBNm 20/16-20/16-200	-	M27	20	20	28	48	100	200	16	16	V0-211205-2020

Długie

Oznaczenie	d_1		d_2	D_3	$D_4=D_5$	L_1	L_2	L_3	a_1	a_2	INDEX
	DIN-371	DIN-376									
PBNm 6/4,9-7/5,5-230	M4,5 - M6	M8	6	7	12,1	26	70	230	4,9	5,5	V0-211235-0607
PBNm 7/5,5-7/5,5-230	M7	M9 - M10	7	7	12,1	26	70	230	5,5	5,5	V0-211235-0707
PBNm 8/6,2-8/6,2-230	M8	M11	8	8	13	30	80	230	6,2	6,2	V0-211235-0808
PBNm 9/7-9/7-230	M9	M12	9	9	15	31	80	230	7	7	V0-211235-0909
PBNm 10/8-10/8-230	M10	-	10	10	15	33	80	230	8	8	V0-211235-1010
PBNm 11/9-11/9-230	-	M14	11	11	18	36	80	230	9	9	V0-211235-1111
PBNm 12/9-12/9-230	-	M16	12	12	18	36	80	230	9	9	V0-211235-1212
PBNm 14/11-14/11-330	-	M18	14	14	22	42	90	330	11	11	V0-211335-1414
PBNm 16/12-16/12-330	-	M20	16	16	22	42	100	330	12	12	V0-211335-1616
PBNm 18/14,5-18/14,5-330	-	M22/M24	18	18	26	43	100	330	14,5	14,5	V0-211335-1818
PBNm 20/16-20/16-330	-	M27	20	20	28	48	100	330	16	16	V0-211335-2020

IK-H6

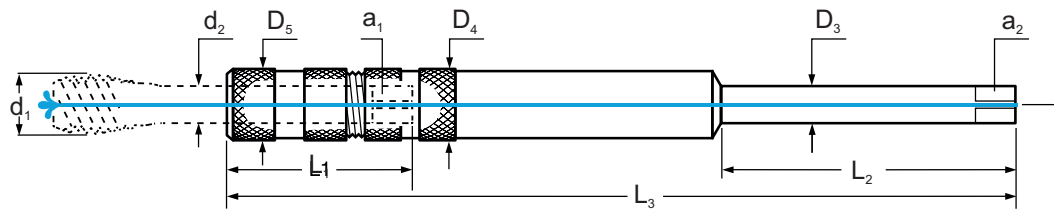

Krótkie

Oznaczenie	d ₁		d ₂	D ₃	D ₄ =D ₅	L ₁	L ₂	L ₃	a ₁	a ₂	INDEX
	DIN-371	DIN-376									
PBNm 2,8/2,1-6/4,9-130	M2 - M2,6	M4	2,8	6	6,1	22	60	130	2,1	4,9	V0-211136-0206
PBNm 3,5/2,7-6/4,9-130	M3	M4,5 - M5	3,5	6	7,5	23	60	130	2,7	4,9	V0-211136-0306
PBNm 4,5/3,4-6/4,9-130	M4	M6	4,5	6	8,4	23	60	130	3,4	4,9	V0-211136-0406
PBNm 6/4,9-7/5,5-130	M4,5 - M6	M8	6	8	12,1	26	60	130	4,9	6,2	V0-211136-0607
PBNm 7/5,5-7/5,5-130	M7	M9 - M10	7	8	12,1	26	60	130	5,5	6,2	V0-211136-0707
PBNm 8/6,2-8/6,2-130	M8	M11	8	8	13	30	60	130	6,2	6,2	V0-211136-0808
PBNm 9/7-9/7-130	M9	M12	9	9	15	31	60	130	7	8	V0-211136-0909
PBNm 10/8-10/8-130	M10	-	10	10	15	33	60	130	8	8	V0-211136-1010
PBNm 11/9-11/9-130	-	M14	11	12	18	36	90	130	9	9	V0-211136-1111
PBNm 12/9-12/9-130	-	M16	12	12	18	36	90	130	9	9	V0-211136-1212
PBNm 14/11-14/11-200	-	M18	14	14	22	42	90	200	11	11	V0-211206-1414
PBNm 16/12-16/12-200	-	M20	16	16	22	42	90	200	12	12	V0-211206-1616
PBNm 18/14,5-18/14,5-200	-	M22/M24	18	18	26	43	100	200	14,5	14,5	V0-211206-1818
PBNm 20/16-20/16-200	-	M27	20	20	28	48	100	200	16	16	V0-211206-2020

Długie

Oznaczenie	d ₁		d ₂	D ₃	D ₄ =D ₅	L ₁	L ₂	L ₃	a ₁	a ₂	INDEX
	DIN-371	DIN-376									
PBNm 6/4,9-7/5,5-230	M4,5 - M6	M8	6	8	12,1	26	70	230	4,9	6,2	V0-211236-0607
PBNm 7/5,5-7/5,5-230	M7	M9 - M10	7	8	12,1	26	70	230	5,5	6,2	V0-211236-0707
PBNm 8/6,2-8/6,2-230	M8	M11	8	8	13	30	80	230	6,2	6,2	V0-211236-0808
PBNm 9/7-9/7-230	M9	M12	9	10	15	31	80	230	7	8	V0-211236-0909
PBNm 10/8-10/8-230	M10	-	10	10	15	33	80	230	8	8	V0-211236-1010
PBNm 11/9-11/9-230	-	M14	11	12	18	36	90	230	9	9	V0-211236-1111
PBNm 12/9-12/9-230	-	M16	12	12	18	36	90	230	9	9	V0-211236-1212
PBNm 14/11-14/11-330	-	M18	14	14	22	42	100	330	11	11	V0-211336-1414
PBNm 16/12-16/12-330	-	M20	16	16	22	42	100	330	12	12	V0-211336-1616
PBNm 18/14,5-18/14,5-330	-	M22/M24	18	18	26	43	100	330	14,5	14,5	V0-211336-1818
PBNm 20/16-20/16-330	-	M27	20	20	28	48	100	330	16	16	V0-211336-2020

Wzorce zarysu gwintu

Gwint metryczny ISO DIN-13

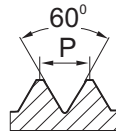

Gwint calowy Whitwortha BS-84:1956

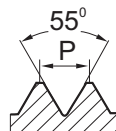

Oznaczenie	Zakres skoków	Ilość listków	INDEX
60°	0,4 ÷ 7 mm	20	V0-600000-0000
55°	62 ÷ 4 1"/P (TPI)	28	V0-550000-0000
55°/60°	62 ÷ 4 1"/P (TPI) 0,25 ÷ 7 mm	58	V0-556000-0000



MODEL	MPD-08/II	MPD-12/II	MPD-16/II	MPD-22/II	MPD-27/II
INDEX	P0-130000-10208	P0-130000-10312	P0-130000-10316	P0-130000-10322	P0-130000-10327
Zakres gwintowania	M2-M8	M3-M12	M3-M16	M3-M22	M3-M27
n [1/min]	700	400	300	120/300	70/220
Pole robocze	Rmax=1900mm		Rmin=200mm		
Masa [kg]	23	23	27	39	39
Max. moment obr. [Nm]	12	32	52	100	160
Wydatek powietrza [l/min]	840	840	840	935	935
Zabieraki w dostawie	FZS19/... M2,3,4,5,6,8	FZS19/... M4,5,6,8,10,12	FZS31/... M6,8,10,12,14,16	FZS31/... M6,8,10,12,16,20	FZS31/... M8,10,12,16,20,24
Zabieraki w opcji	-	FZS19/M3	FZS19/...M3,4,5 +FR31/19	FZS19/...M3,4,5 +FR-31/19; FZS31/...M14,18,22	FZS19/...M3,4,5 +FR-31/19; FZS31/...M6,14,18,22,27

Wyposażenie standardowe

- wrzeciono z napędem pneumatycznym
- podwójne sztywne ramię
- kolumna mocująca
- system przygotowania powietrza
- promieniowy wysięgnik
- sześć zabieraków do gwintowników



Pełna oferta zabieraków FZS oraz redukcji FR na str. 239 i 241

Głowica uchylna do mocowania wrzeciona z płynną regulacją kąta 0-90°



MODEL	Masa	INDEX
MGO-08-90°	1,1 kg	P0-133000-00890
MGO-12-90°	1,1 kg	P0-133000-01290
MGO-16-90°	1,5 kg	P0-133000-01690
MGO-22-90°	1,5 kg	P0-133000-02290
MGO-27-90°	1,5 kg	P0-133000-02790

Podstawa magnetyczna do maszyn



MODEL	Siła mocująca	Wymiary	Do maszyny	Masa	INDEX
MMP-300	300 kg	150x90x93	MPD-08,12,16	8,6 kg	P0-133000-00300
MMP-600	600 kg	224x115x120	MPD-22,27	21 kg	P0-133000-00600

Adaptory do uchwytu wiertarskiego



Uchwyty wiertarskie

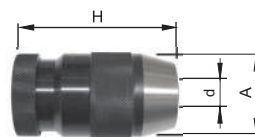

MODEL	d	Stożek	A	INDEX	MODEL	Stożek	A	H	d	INDEX
FZA19/JT2	19	JT2	30	R-FZA19/JT2	OW-JT2/D8	JT2	38	68	0-8	R-OW-JT2/D8
FZA19/JT6	19	JT6	30	R-FZA19/JT6	OW-JT6/D13	JT6	48	90	0-13	R-OW-JT6/D13
FZA31/JT6	31	JT6	48	R-FZA31/JT6						

Pneumatyczne gwinciarki ręczne

MPP-12-1

Z głowicą elastyczną



MPP-12-3

Z oprawką na zabieraki FZS



MODEL	M	n [1/min]	Stożek	Wydatek powietrza	Średnica przewodu zasil.	Masa	Wyposażenie	INDEX
MPP-12-1	M2-M12	250	B12	400 l/min	9,5 mm	2 kg	Rękojeść	P0-136000-00121
MPP-12-3	M2-M12	250	B12	400 l/min	9,5 mm	1,5 kg	Rękojeść + FZS19/...M3,4,5,6,8,10	P0-136000-00123

PMW-1300 $\varnothing 2\text{mm} \div \varnothing 13\text{mm}$
INDEX: PMW-1300
Wymiary: 305x172x180 (mm)

Zakres średnic wiertel: $\varnothing 2 \div \varnothing 13$
Zakres kątów wierzchołkowych: $85^\circ - 140^\circ$
Zasilanie: 220÷230 V 50Hz
Moc silnika: 90 W
Prędkość obrotu tarczy szlifierskiej: 6000 obr/min
Waga: 10 kg
Ściernica: B200
Tulejki: ER-20

Akcesoria w zestawie:

Tulejki ER20 $\varnothing 2,5 \div \varnothing 13$ - 12 szt., Ściernica B200 - 1 szt.,
 Klucz imbusowy 4mm i 6mm po 1 szt.

PMW-2000 $\varnothing 3\text{mm} \div \varnothing 20\text{mm}$
INDEX: PMW-2000
Wymiary: 480x260x240 (mm)

Zakres średnic wiertel: $\varnothing 3 \div \varnothing 20$
Zakres kątów wierzchołkowych: $85^\circ - 140^\circ$
Zasilanie: 220÷230 V 50Hz
Moc silnika: 450 W
Prędkość obrotu tarczy szlifierskiej: 4300 obr/min
Waga: 21 kg
Ściernica: CBN200
Tulejki: ER-25

Akcesoria w zestawie:

Tulejki ER25 $\varnothing 3 \div \varnothing 20$ - 18 szt., Ściernica CBN#200 - 1 szt.,
 Klucz imbusowy 4mm i 6mm po 1 szt.

PMW-3000 $\varnothing 12\text{mm} \div \varnothing 26\text{mm}$
INDEX: PMW-3000
Wymiary: 470x260x235 (mm)



Zakres średnic wiertel: $\varnothing 12 \div \varnothing 26$, opcjonalnie $\varnothing 8 \div \varnothing 30$
Zakres kątów wierzchołkowych: $85^\circ - 140^\circ$
Zasilanie: 220÷230 V 50Hz
Moc silnika: 450 W
Prędkość obrotu tarczy szlifierskiej: 4300 obr/min
Waga: 25 kg
Ściernica: B150
Tulejki: ER-40

Akcesoria w zestawie:

Tulejki ER40 $\varnothing 12 \div \varnothing 26$ - 15 szt., Ściernica B150 - 1 szt.,
 Klucz imbusowy 4mm i 6mm po 1 szt.



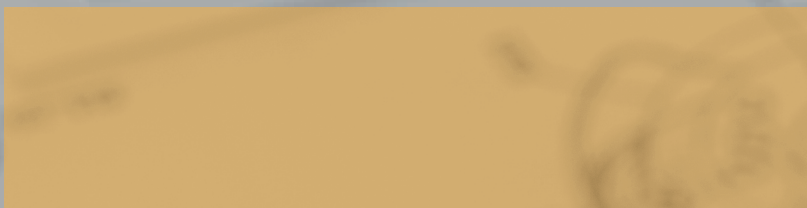

































INFORMACJE
TECHNICZNE



1. Rodzaje gwintów	277 - 278
2. Materiały używane do produkcji narzędzi	279
3. Powłoki PVD stosowane na narzędzia	280 - 282
4. Gwintowniki	283 - 295
5. Wygniataki	296 - 299
6. Narzynki	300 - 302
7. Sprawdziany	303 - 307
8. Wiertła	308 - 310
9. Oprawki maszynowe	311 - 317
10. Frezy trzpieniowe	318 - 328
11. Tabele informacyjne	329 - 340
12. Formularz doboru narzędzia	341 - 346

1. RODZAJE GWINTÓW

M		Gwint metryczny zwykły ISO DIN-13
MF		Gwint metryczny drobnozwojny ISO DIN-13 (symbol używany tylko w katalogach dla odróżnienia od gwintów metrycznych zwykłych)
UNC		Gwint amerykański zunifikowany ANSI B-1.1
UNF		Gwint amerykański zunifikowany drobnozwojny ANSI B-1.1
UNEF		Gwint amerykański zunifikowany ekstra drobnozwojny ANSI B-1.1
UNJC		Gwint amerykański zunifikowany przeznaczony do lotnictwa UNJC ASME B1.15
UNJF		Gwint amerykański zunifikowany drobnozwojny przeznaczony do lotnictwa UNJF ASME B1.15
G		Gwint rurowy walcowy Whitwortha DIN-ISO 228 (identyczny z BSP)
Rp		Gwint rurowy walcowy Whitwortha wewnętrzny PN-ISO 7/1 i DIN EN 10226-1 (identyczny z BSPP)
Rc		Gwint rurowy stożkowy Whitwortha wewnętrzny PN-ISO 7/1, DIN EN 10226-2 (identyczny z BSPT)
NPT		Gwint amerykański rurowy stożkowy ze szczelnością nie uzyskiwaną na gwincie ANSI B-1.20.1
NPTF		Gwint amerykański rurowy stożkowy ze szczelnością uzyskiwaną na gwincie ANSI B 1.20.4
NPSF		Gwint amerykański rurowy walcowy ANSI B 1.20.3
BSW		Gwint całowy zwykły Whitwortha BS-84 (dawniej W)
BSF		Gwint całowy drobnozwojny Whitwortha BS-84
EG M		Gwint do wkładek gwintowych V-Coil
EG UNC		Gwint do wkładek gwintowych V-Coil
EG UNF		Gwint do wkładek gwintowych V-Coil
Pg		Gwint do rurek instalacyjnych stalowych DIN-40430 (pancerny P). Obecnie gwint Pg jest zastępowany przez znormalizowany drobnozwojny gwint metryczny wg DIN EN 60423
Tr		Gwint trapezowy symetryczny DIN-103

R		Gwint rurowy stożkowy Whiwortha zewnętrzny ISO-7/1 (identyczny z BSPT)
Rd		Gwint okrągły DIN 405
FG		Gwint rowerowy DIN 79012
BSC		Gwint rowerowy BS 811
Ven		Gwint wentylowy PN-ISO 4570
Vg		Gwint wentylowy DIN 7756
E		Gwint elektrotechniczny Edisona IEC 60061
UN		Gwint amerykański zunifikowany ANSI B-1.1 (o uprzywilejowanych skokach: 4, 6, 8, 12, 16, 20, 28, 32 zwoje na cal)
UNS		Gwint amerykański zunifikowany specjalny ANSI B-1.1
Whit. S		Gwint Whitwortha specjalny BS 84
S		Gwint trapezowy niesymetryczny
Wzyl		Gwint walcowy do zaworów butli gazowych DIN 477
Wkeg		Gwint stożkowy do zaworów butli gazowych PN-EN ISO 11363 DIN 477
NPSM (NPS)		Gwint amerykański rurowy walcowy ANSI B 1.20.1

2. MATERIAŁY UŻYWANE DO PRODUKCJI NARZĘDZI

Symbol	Nazwa	Opis
HSS	Stal szybko tnąca	Standardowy materiał na narzędzia skrawające ogólnego stosowania
HSSE (HSCo5)	Stal szybko tnąca	Materiał o podwyższonej odporności termicznej, zawartość kobaltu pozwala na podwyższenie temperatury hartowania oraz zwiększa stabilność ostrzy
HSSE-PM	Stal szybko tnąca proszkowa	Materiał narzędziowy o jednolitej strukturze, uzyskiwany w technologii metalurgii proszków, o wysokiej twardości oraz odporności na wysokie temperatury, narzędzia wykonane z tego materiału charakteryzuje wysoka stabilność ostrzy
VHM	Węglik spiekany drobnoziarnisty	Materiał narzędziowy o jednolitej strukturze, uzyskiwany w technologii metalurgii proszków z węglików wolframu, charakteryzują się wysoką odpornością na ścieranie oraz twardością, w porównaniu do stali szybko tnących jest bardziej kruchy, zwykle stosowany wraz z powłokami PVD

3. POWŁOKI PVD STOSOWANE NA NARZĘDZIA

POWŁOKA HL

Powłoka	TiAIN + WC/C
Struktura	Wielowarstwowa nano-kompozytowa
Twardość	3000 HV _{0,05}
Max. temp. pracy	800°C
Współczynnik tarcia	0,15
Kolor powłoki	Ciemnoszary 

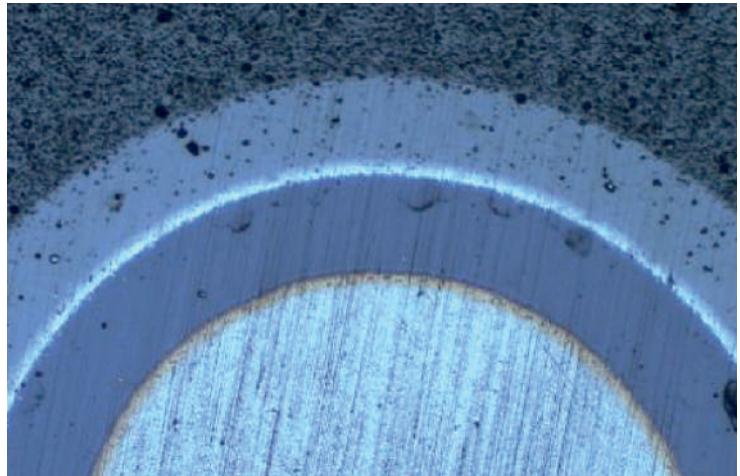

Wysokie właściwości użytkowe powłoki HL osiągnięto dzięki zastosowaniu zaawansowanej struktury nano-kompozytowej. Warstwa TiAIN dzięki wysokiej twardości oraz odporności temperaturowej stanowi stabilną, odporną na ścieranie bazę powłoki. Warstwa wierzchnia WC/C składająca się z nanokrystalitów węgla wolframu otoczonych węglową osnową charakteryzuje się doskonałymi właściwościami tribologicznymi. Twarde wydzielenia WC zapewniają odporność na ścieranie przy znakomitych właściwościach ślizgowych węgla. Połączenie zalet obydwu warstw sprawia że powłoka HL doskonale sprawdza się w obróbce szerokiego spektrum materiałów, poprawia odprowadzanie wiórów, zmniejsza siły skrawania oraz chroni krawędzie skrawające przed wpływem wysokich temperatur. Narzędzia powlekane powłoką HL mogą pracować w warunkach minimalnej ilości chłodziwa (MQL).

Powłoka przeznaczona do obróbki materiałów z grup P, M, K,N, S.

POWŁOKA TS

Powłoka	TiAIN + TiAlSiN
Struktura	Wielowarstwowa nanokompozytowa
Twardość	3800 HV _{0,05}
Max. temp. pracy	1100°C
Współczynnik tarcia	0,15
Kolor powłoki	Miedziany 

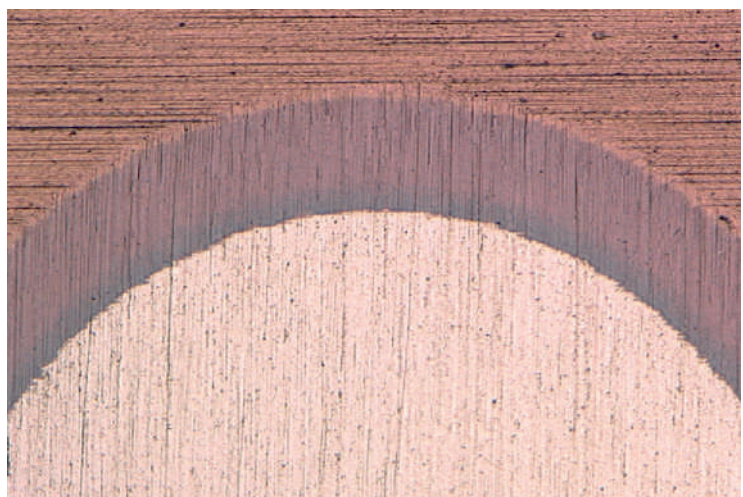

Powłoka TS ma wielowarstwową nanokompozytową strukturę. Jej bazą jest TiAIN z zawartością krzemu (Si). Produkowana jest w najnowszej technologii HiPIMS, zapewniającej właściwości mechaniczne nieosiągalne przy innych technikach powlekania. Jest to możliwe dzięki niezwykle precyzyjnemu kontrolowaniu składu powłoki w tej metodzie. Umożliwia to wytworzenie jednorodnej powłoki o najwyższej twardości i odporności na pękanie. Skład chemiczny i sposób nakładania sprawia, że powłoka TS świetnie sprawdza się w trudnych do obróbki materiałach z grup M, S, H, a także w popularnych materiałach z grup P oraz K.

POWŁOKI PVD STOSOWANE NA NARZĘDZIA

POWŁOKA TN2

Powłoka	TiAlN + TiN
Struktura	Dwuwarstwowa nanostrukturalna
Twardość	3500 HV _{0,05}
Max. temp. pracy	800°C
Współczynnik tarcia	0,3
Kolor powłoki	Złoty 

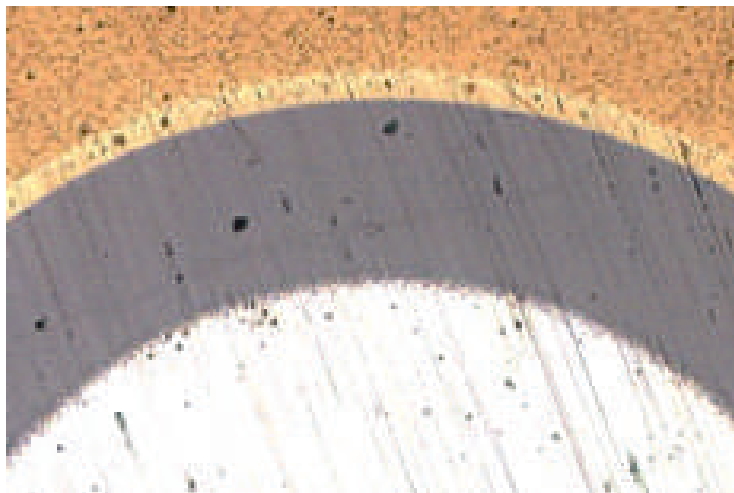

Dwuwarstwowa powłoka TN2 wytwarzana metodą bezkroplową podlegająca procesom uszlachetnienia powierzchni charakteryzuje się bardzo dobrą odpornością na ścieranie, dużą odpornością termiczną oraz niskim współczynnikiem tarcia. Dzięki zmniejszeniu tarcia żywotność narzędzi znacząco się wydłuża, a jakość obrabianej powierzchni wzrasta. Łącząc wyjątkowo twardą warstwę TiAlN z podatną warstwą TiN, uzyskano inteligentną samonastawną strukturę powierzchni dopasowującą się do powstających podczas obróbki naprężeń zwiększając odporność na pękanie. TN2 przeznaczona jest w szczególności na narzędzia do obróbki materiałów z grupy P (dla Rm <1000 MPa), oraz materiałów z grupy M, K, N.

POWŁOKA TC

Powłoka	TiN + TiCN
Struktura	Wielowarstwowa
Twardość	3700 HV _{0,05}
Max. temp. pracy	400°C
Współczynnik tarcia	0,2
Kolor powłoki	Antracytowy 



TC to wielowarstwowa powłoka o uniwersalnym zastosowaniu. Charakteryzuje się bardzo wysoką twardością, dobrą wytrzymałością i niskim współczynnikiem tarcia. Bazowa warstwa TiN zapewnia wysoką przyczepność do narzędzia oraz znaczną odporność na dynamiczne obciążenia. Wierzchnia warstwa TiCN/TiC dzięki wysokiej twardości oraz niskiemu współczynnikowi tarcia zapewnia bardzo dobrą odporność na ścieranie. Połączenie tych właściwości pozwala na zabezpieczenie krawędzi przed narostem materiału obrabianego oraz wykruszaniem. Ze względu na stosunkowo niską odporność temperaturową należy stosować odpowiednie chłodzenie narzędzia. Przeznaczona głównie na narzędzia do obróbki materiałów z grupy P (w szczególności o podwyższonej wytrzymałości Rm >1000 MPa) K, N, H.

POWŁOKI PVD STOSOWANE NA NARZĘDZIA

POWŁOKA AT

Powłoka	AlTiN
Struktura	Gradientowa
Twardość	3700 HV _{0,05}
Max. temp. pracy	900°C
Współczynnik tarcia	0,3
Kolor powłoki	Fioletowo-szary 

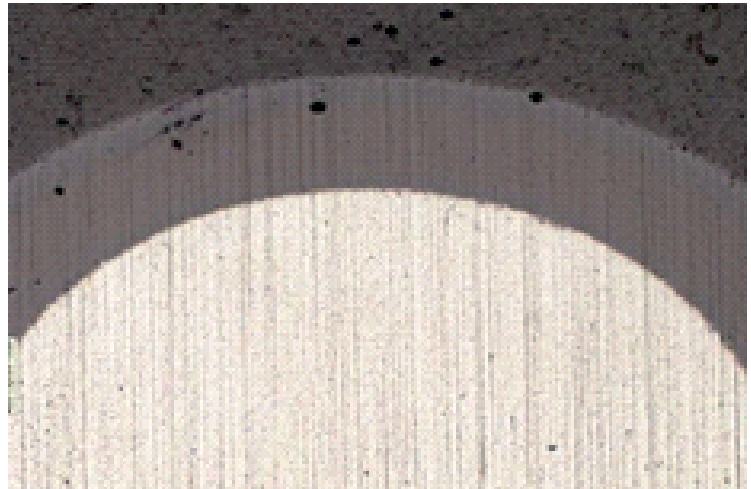

Powłoka AT dzięki podwyższonej zawartości aluminium (Al) charakteryzuje się wysoką twardością oraz odpornością temperaturową. Wytwarzające się podczas eksploatacji powłoki, tlenki glinu stanowią dodatkowe smarowanie narzędzia jednocześnie tworząc barierę cieplną zapobiegającą degradacji powłoki nawet w najcięższych warunkach. Skład chemiczny oraz nanogradientowa struktura zapewnia wysoką twardość powłoki. W efekcie uzyskuje wysoką odporność na ścieranie co przekłada się na zwiększoną żywotność narzędzia. Powlekanie nią mogą być narzędzia narażone na duże zmiany temperatury, odpowiednia zarówno do pracy z chłodziwem jak i na sucho. Powłoka przeznaczona jest do obróbki materiałów z grupy P, M, K, N, S.

POWŁOKA TiB₂

Powłoka	TiB ₂
Struktura	Monowarstwowa
Twardość	4000 HV _{0,05}
Max. temp. pracy	900°C
Kolor powłoki	Srebrny 



Materiał powłoki TB (dwuborek tytanu) jest ceramiką wyróżniającą się twardością oraz odpornością na ścieranie. Dzięki starannie dobranej składowi (brak powinowactwa z aluminium), gwarantuje wysoką stabilność chemiczną oraz zapobiega występowaniu narostu obrabianego materiału na krawędziach skrawających. Bezdroplowa metoda wytwarzania powłoki pozwala na uzyskanie wysokiej gładkości co pozwala na uzyskanie bardzo dobrej jakości powierzchni obrabianych detali. Powłoka przeznaczona do obróbki materiałów z grupy N, głównie stopy aluminium (Si<12%) oraz tytanu niestopowego.

4. GWINTOWNIKI

4.1. Elementy konstrukcyjne gwintownika (na przykładzie DIN-371)

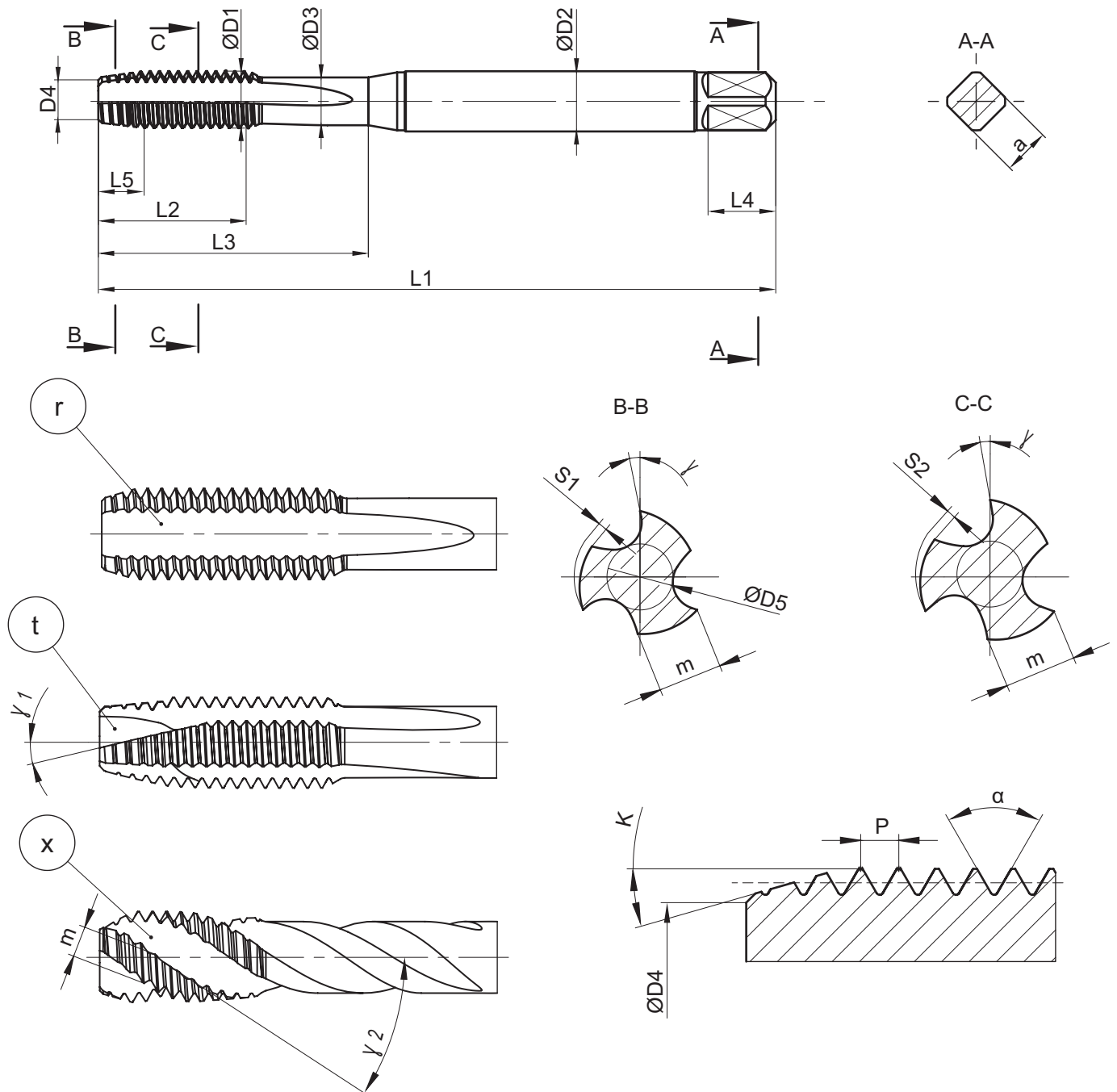

L1 - długość całkowita
 L2 - długość części roboczej
 L3 - długość użytkowa
 L4 - długość zabieraka kwadratowego
 L5 - długość części skrawającej (nakroju)
 a - wielkość zabieraka kwadratowego
 ØD1 - średnica znamionowa gwintu
 ØD2 - średnica chwytu
 ØD3 - średnica szyjki
 ØD4 - średnica czołowa
 ØD5 - średnica rdzenia
 m - grubość ostrza

S1 - zatoczenie nakroju
 S2 - zatoczenie gwintu
 P - podziałka gwintu (skok)
 α - kąt zarysu gwintu
 γ - kąt natarcia
 γ₁ - kąt pochylenia skośnej powierzchni natarcia
 γ₂ - kąt pochylenia linii śrubowej
 κ - kąt przystawienia (nakroju)
 r - rowek wiórowy prosty
 x - rowek wiórowy śrubowy
 t - skośna powierzchnia natarcia
 z - ilość ostrzy

4.2. Normy wymiarowe

Normy wymiarowe przyporządkowują wymiarom nominalnym gwintów odpowiednie szeregi wymiarów zewnętrznych gwintowników (długość całkowitą, długość części roboczej, średnicę chwytu i wymiar zabieraka kwadratowego).

Symbol	Opis
DIN-371	Gwintowniki maszynowe z chwytem wzmocnionym do gwintów metrycznych zwykłych i drobnozwojnych M1 ÷ M10 oraz do gwintów UNC, UNF, BSW, BSF w zakresie średnic nominalnych 1/8" ÷ 3/8"
DIN-376	Gwintowniki maszynowe z chwytem przelotowym do gwintów metrycznych zwykłych M oraz do gwintów UNC i BSW
DIN-374	Gwintowniki maszynowe z chwytem przelotowym do gwintów metrycznych drobnozwojnych MF oraz do gwintów UNF i BSF
DIN-5156	Gwintowniki maszynowe z chwytem przelotowym do gwintów G, Rp i Rc
DIN-352	Gwintowniki ręczne do gwintu metrycznego zwykłego. Norma ta znajduje również zastosowanie do gwintów UNC i BSW
DIN-2181	Gwintowniki ręczne do gwintu metrycznego drobnozwojnego. Norma ta znajduje również zastosowanie do gwintów UNF i BSF
DIN-5157	Gwintowniki ręczne do gwintu rurowego G i Rp

4.2. Grupy narzędzi według zastosowania

<p>MASTERTAP</p> <p>P M K N S</p>	<p>Grupa gwintowników przeznaczona do wysokowydajnego gwintowania szerokiego spektrum materiałów takich jak stale, stale nierdzewne, żeliwa, metale nieżelazne oraz stopy żaroodporne i stopy tytanu.</p> <p>Gwintowanie może być wykonywane zarówno na nowoczesnych wydajnych centrach obróbczych z dużymi prędkościami skrawania, jak i na maszynach numerycznych starszego typu oraz na konwencjonalnych obrabiarkach przy nieco niższych parametrach obróbki.</p>
<p>800X</p> <p>P M K N</p>	<p>Rozwojowa odmiana gwintownika 800, przeznaczona również do obróbki stali nierdzewnej. Wykorzystane innowacyjne technologie produkcji gwarantują nawet dwukrotnie wyższą od dotychczasowej trwałość oraz wydajność obróbki.</p> <p>Wszystkie te cechy czynią gwintownik 800X najlepszym wyborem dla krótkich i średnich serii produkcyjnych, oferując w dalszym ciągu korzystną relację ceny do jakości.</p>
<p>800</p> <p>P K N</p>	<p>do stali konstrukcyjnych węglowych, automatowych i niskostopowych, o wytrzymałości $\leq R_m \leq 800 \text{ Mpa}$</p>
<p>FAN-1200</p> <p>P</p>	<p>do stali narzędziowych i trudnoobrabialnych o wytrzymałości $800 \text{ MPa} \leq R_m \leq 1200 \text{ MPa}$ oraz ulepszanych cieplnie do 38 HRC</p>
<p>1400-HT</p> <p>P M K N</p>	<p>do obróbki twardych i ścierających materiałów takich jak stale o wytrzymałości R_m od 1200 do 1400 MPa oraz aluminium z wysoką zawartością krzemu.</p>
<p>INOX</p> <p>P M</p>	<p>do stali wysokostopowych, nierdzewnych i kwasoodpornych o wytrzymałości $R_m \leq 1000 \text{ MPa}$</p>
<p>GG</p> <p>K</p>	<p>do obróbki żeliwa szarego i sferoidalnego</p>
<p>GAL</p> <p>N</p>	<p>do odlewniczych stopów aluminium o zawartości Si max 12%</p>
<p>HRC</p> <p>H</p>	<p>do materiałów w stanie zahartowanym. Liczba obok symbolu oznacza maksymalną twardość materiału obrabianego w skali HRC</p>
<p>S-NC</p> <p>P M K N S</p>	<p>do gwintowania synchronicznego na obrabiarkach CNC z funkcją „rigid tapping” szerokiej gamy materiałów z dużymi prędkościami skrawania</p>
<p>Ms</p> <p>N</p>	<p>do mosiądzu i brązu krótkowiórowego</p>

4.3. Typ nakroi gwintowników maszynowych

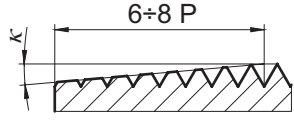
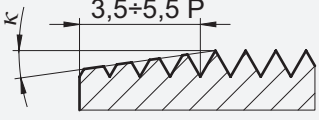
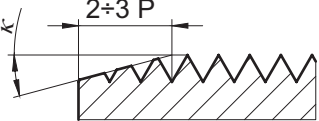
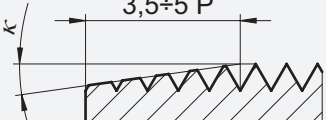
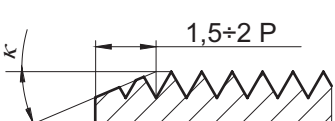
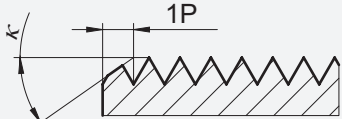
Symbol	Szkic	Długość nakroju wyrażona w ilości zwojów gwintu	Kąt nakroju
A		$6 \div 8 P$	5°
B		$3,5 \div 5,5 P$	8°
C		$2 \div 3 P$	17°
D		$3,5 \div 5 P$	8°
E		$1,5 \div 2 P$	23°
F		$1 P$	35°

4.4. Rodzaje rowków wiórowych gwintowników maszynowych

Rowki proste

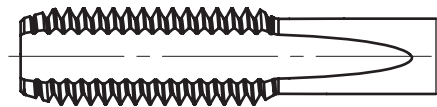

W połączeniu z nakrojem A lub D stosowane do otworów przelotowych natomiast z nakrojem E lub F do nieprzelotowych. Gwintownik z nakrojem C może być stosowany do obydwu rodzajów otworów.

Zalecany do materiałów dających krótki wiór. Rowki odprowadzają tylko część wiórow, które nieznacznie przesuwają się wzdłuż osi. Nie należy stosować go do głębokich otworów nieprzelotowych i materiałów długowiórowych. Długość wykonywanych gwintów do ok $1,5xD$

Rowki proste ze skośną powierzchnią natarcia

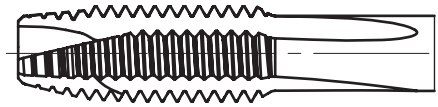

Przeznaczone do otworów przelotowych z gwintem na pełnej długości otworu.

Wraz z nakrojem B zalecany do materiałów dających długi wiór. Skośna powierzchnia natarcia przemieszcza ciasno zgnieciony wiór w kierunku posuwu i zapobiega zapychaniu się rowków. Chłodziwo swobodnie dociera do strefy roboczej. Długość wykonywanych gwintów do ok. 3xD.

Rowki śrubowe

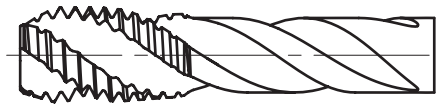

Wraz z nakrojem C i E stosowane do otworów nieprzelotowych.

Zalecany do materiałów dających długi wiór. Rowki śrubowe zapewniają dobre odprowadzanie wiórów z otworu w kierunku chwytu. W zależności od średnicy możliwe jest wykonywanie gwintów do 2,5xD.

Gwintownika z rowkami skrętnym nie należy stosować do otworów przelotowych.

4.6. Rodzaje nakiełków gwintowników wysokowydajnych w zależności od średnicy gwintu, nakroju oraz normy wykonania

Część robocza		Chwyt	
Nakiełek pełny	①		⑤ Faza
Nakiełek odsadzony	②		
Nakrój E (bez nakiełka)	③		
Nakiełek wewnętrzny	④		⑥ Nakiełek wewnętrzny

	Średnica zewnętrzna gwintu (mm)	Rodzaj nakiełka po stronie części skrawającej			Rodzaj nakiełka po stronie chwytu
		Nakroje A, C, D	Nakrój B	Nakroje E, F	
DIN-371	≤7,2	①	①	③	⑤
	7,2≤8,2	②	①	③	⑤
	8,2<10,2	②	②	③	⑤
DIN-374	≤7,2	①	①	③	⑤
DIN-376	>7,2	④	④	④	⑥
DIN-5156	>7,2	④	④	④	⑥

**Długości nakiełków pełnych dla wybranych rodzajów gwintu
(długość nakiełków odsadzonych $L_{nak}=1,8$ mm)**

M		MF	
M1	0,6	M2,5 x 0,35	1,9
M1,2	0,8	M2,6 x 0,35	1,9
M1,4	1,0	M3 x 0,35	1,3
M1,6	1,1	M 3,5 x 0,35	1,6
M1,7	1,1	M4 x 0,5	1,8
M1,8	1,3	M5 x 0,5	2,3
M2	1,4	M6 x 0,75	2,6
M2,5	1,8	M7 x ,75	3,1
M2,6	1,8		
M3	1,3		
M3,5	1,5		
M4	1,7		
M4,5	1,9		
M5	2,1		
M6	2,5		
M7	3,0		
UNC		UNF	
No 4-40	2,0	No 4-48	2,1
No 5-40	1,3	No 5-44	1,4
No 6-32	1,4	No 6-40	1,5
No 8-32	1,8	No 8-36	1,8
No 10-24	2,0	No 10-32	2,1
No 12-24	2,3	No 12-28	2,3
1/4-20	2,6	1/4 - 28	2,8
5/16-18	3,3	5/16 - 24	3,5
BSW		BSF	
1/8 - 40	1,25	1/4 - 26	2,65
3/16 - 24	1,8	5/16 - 22	3,4
1/4 - 20	2,55		
5/16 - 18	3,25		

4.7. Zastosowanie narzędzi z wewnętrznymi kanałami doprowadzającymi chłodziwo IK/IKR

IK – centralny kanał doprowadzający chłodziwo, zalecany do otworów nieprzelotowych, ułatwia odprowadzanie wiórów w kierunku chwytu, poprawia warunki smarowania i chłodzenia, wpływa korzystnie na trwałość narzędzia.



IKR – centralny kanał doprowadzający chłodziwo rozdzielający się na kilka kanałów promieniowych, doprowadzających chłodziwo do każdego rowka wiórowego oddzielnie, rozwiązanie zalecane do gwintowania otworów przelotowych, ułatwia odprowadzanie wiórów w kierunku posuwu, poprawia warunki smarowania i chłodzenia, wpływa korzystnie na trwałość narzędzia.



4.8. Klasy gwintowników

Oferowane w naszym katalogu gwintowniki wykonywane są w klasie podstawowej przeznaczonej do najpowszechniej stosowanych tolerancji gwintu wewnętrznego, właściwych konkretnemu rodzajowi gwintu: dla gwintu metrycznego 6H, dla gwintu zunifikowanego UNC, UNF - 2B, dla gwintu Whitwortha BSW, BSF - „normal”. Wykonanie w innych klasach jest możliwe na zamówienie.

Klasy gwintowników (tzn. pola tolerancji części roboczej) do gwintu metrycznego są zunifikowane normami międzynarodowymi i krajowymi. Określona klasa gwintownika pozwala uzyskać gwinty o dwóch lub trzech polach tolerancji (patrz rysunek i tabela poniżej).

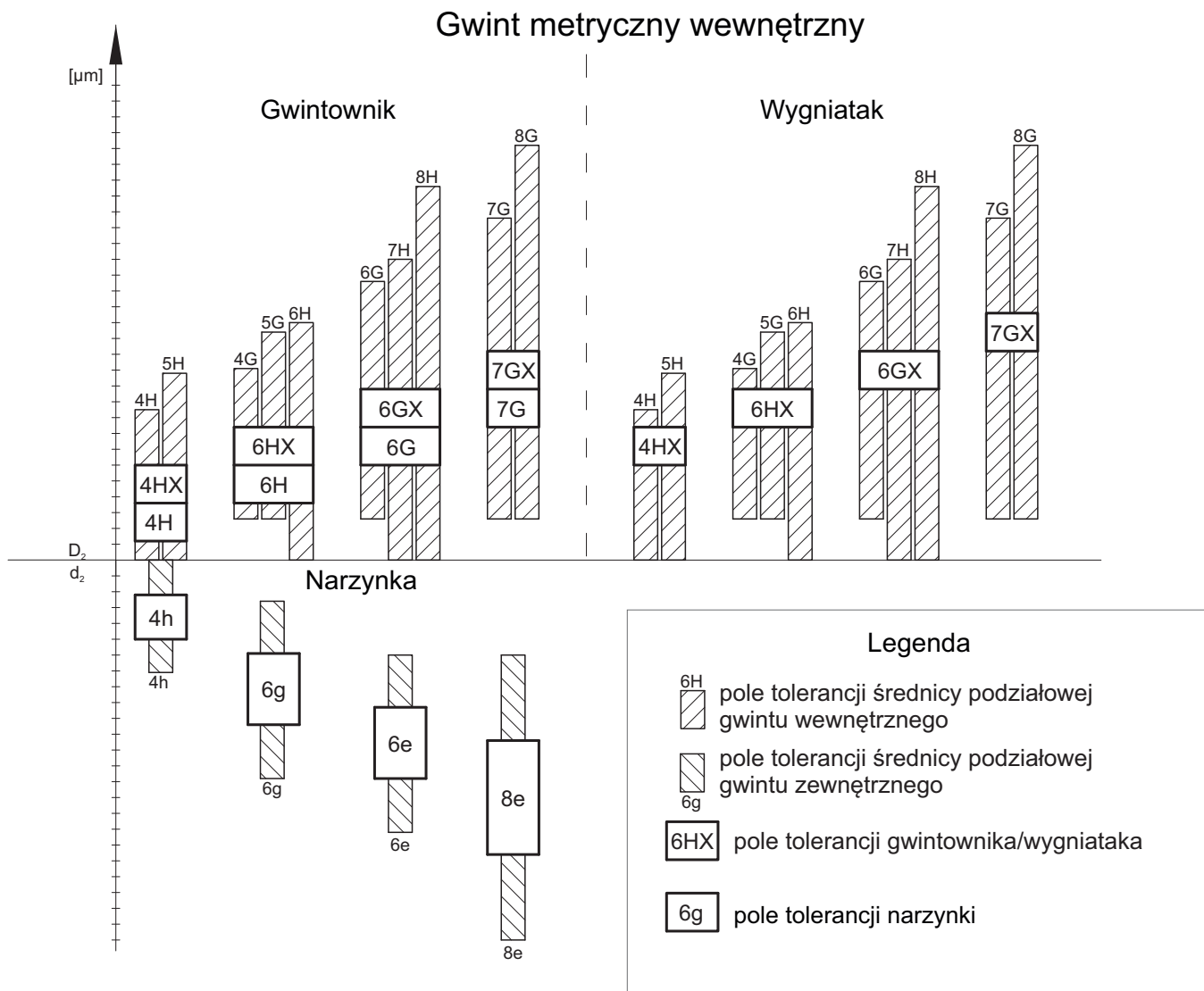

Wg normy DIN 802	Pole tolerancji gwintu wewnętrznego				
4H	4H	5H	-	-	-
6H	4G	5G	6H	-	-
6G	-	-	6G	7H	8H
7G*	-	-	-	7G	8G

*DIN 802 przewiduje możliwość skorygowania tolerancji gwintownika w stosunku do wymagań normy w przypadku gdy wymagają tego szczególne warunki obróbki np. gatunek materiału obrabianego. Wtedy obowiązuje symbol klasy gwintownika ze znakiem „X” np.: 6HX, 6GX.

4.9. Oznaczenia i cechowanie gwintowników

Oznaczenie

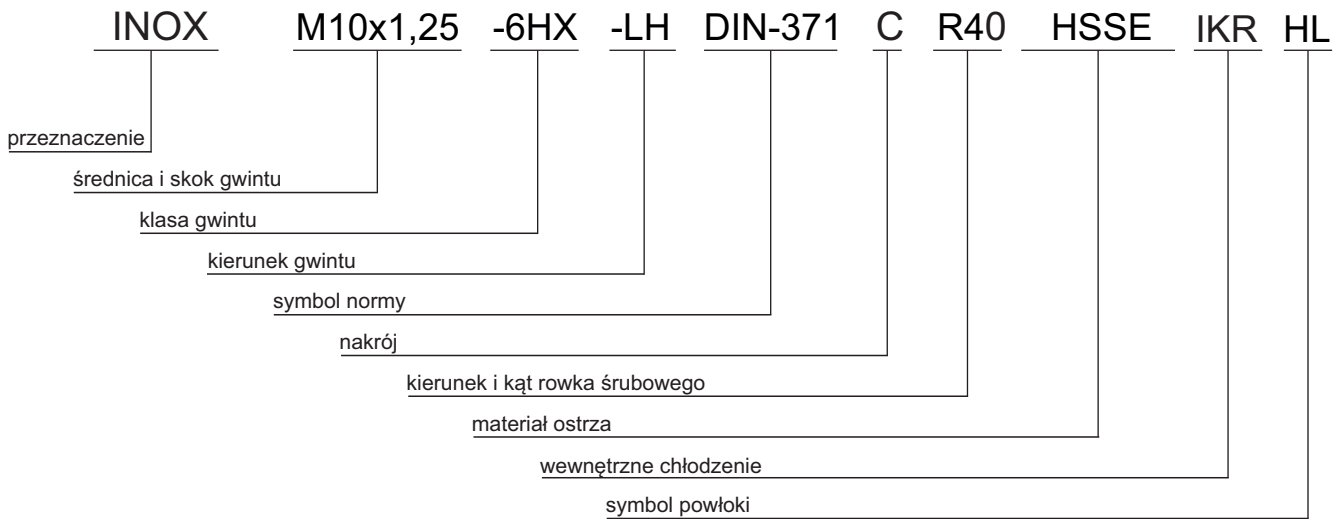

Cechowanie

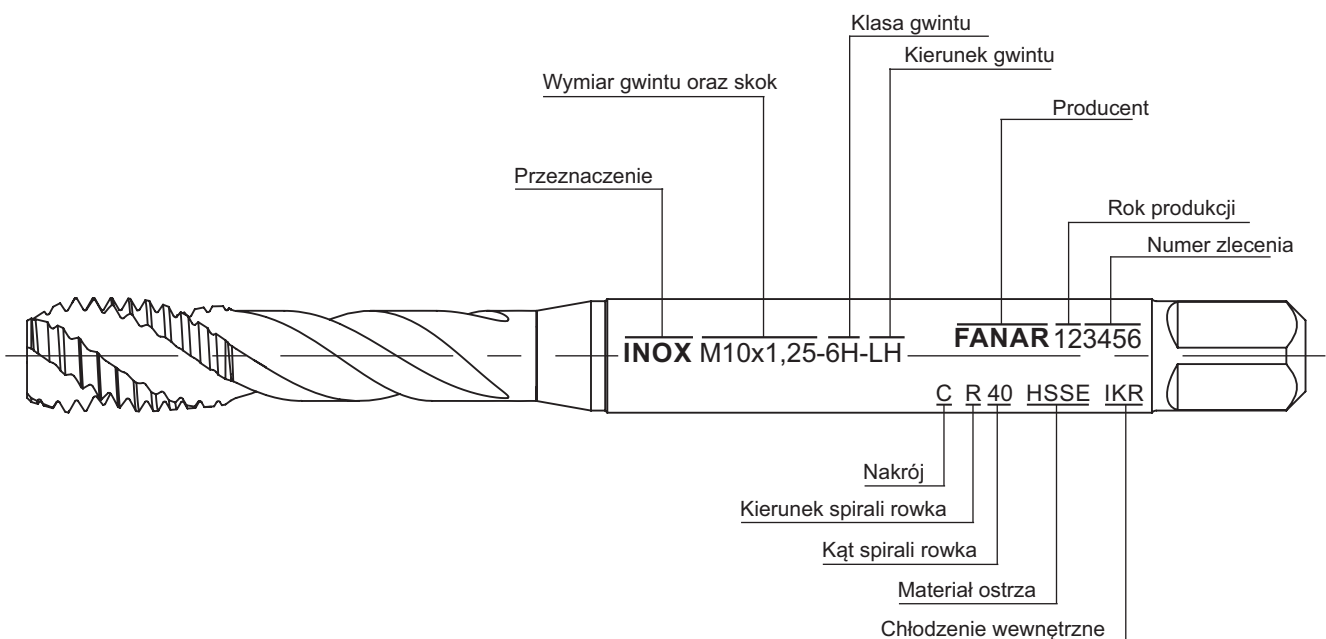

4.10. Zalecenia dotyczące procesu obróbki gwintownikami maszynowymi

Gwintowanie zwykle jest jedną z ostatnich operacji obróbki wiórowej detalu. Błąd podczas nacinania gwintu może skutkować dodatkowymi kosztami nie tylko związanymi z uszkodzonym gwintownikiem, ale często obrabianym materiałem, a także całą poprzedzającą gwintowanie obróbką. W celu uniknięcia takiego problemu zachęcamy do zapoznania się i stosowania poniższych zaleceń dotyczących procesu gwintowania.

4.11. Przebieg procesu gwintowania

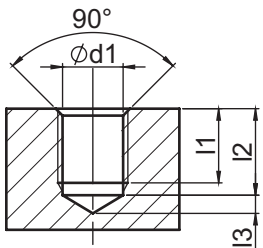
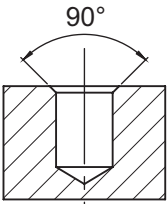
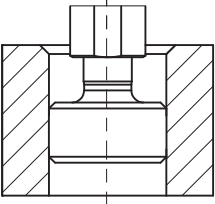
Operacja		Zalecenia
10	<p style="text-align: center;">Wiercenie</p>  <p>$\varnothing d1$ - zalecana średnica pod gwint $l1$ - głębokość gwintu $l2$ - głębokość otworu pod gwint $l3$ - długość wierzchołka</p>	<ul style="list-style-type: none"> - Średnica wiertła (rozdział 6, str 141) powinna być zgodna z zalecaną wartością podaną na stronie katalogowej wykorzystywanego . - W przypadku materiałów o $R_m > 1200$ MPa średnica otworu powinna być możliwie bliska górnej odchyłce jego tolerancji. - W przypadku otworu nieprzelotowego w celu uzyskania pożądanej długości użytecznej gwintu, głębokość wierzonego otworu powinna uwzględniać długość wierzchołka wiertła, długość nakiełka gwintownika (tabela na str. 288) oraz nakroju.
20	<p style="text-align: center;">Fazowanie krawędzi otworu</p> 	<ul style="list-style-type: none"> - W celu ułatwienia wprowadzenia gwintownika w otwór oraz zmniejszenia oporów w początkowej fazie jego pracy należy załamać krawędzie wywierconego otworu fazownikiem o kącie wierzchołkowym 90° (rozdział 6, str. 172).
30	<p style="text-align: center;">Sprawdzenie poprawności otworu pod gwint</p> 	<ul style="list-style-type: none"> - Podczas nacinania gwintu gwintownikiem, średnica rdzeniowa wynika ze średnicy wywierconego otworu. Poprawność wykonanych otworów należy sprawdzić sprawdzianem gładkim do otworów pod gwinty (rozdział 7, str. 219) zgodnie z zaleceniami zawartymi w sekcji technicznej dotyczącej sprawdzianów.

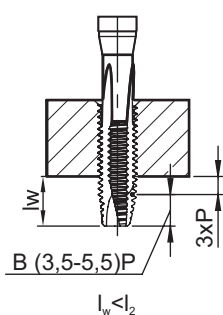
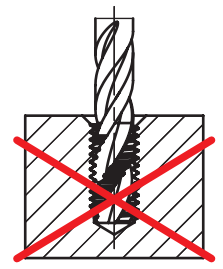
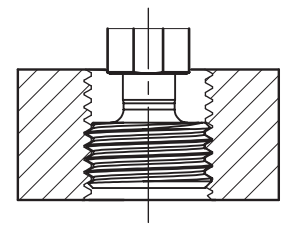
Operacja		Zalecenia
40	Gwintowanie	<p>- Podczas gwintowania otworów przelotowych gwintownikiem ze skośną powierzchnią natarcia, należy zwrócić szczególną uwagę na wybieg gwintownika z otworu. Dla prawidłowego nacięcia gwintu oraz wyprowadzenia wiórów wybieg gwintownika z otworu powinien wynosić całą długość skośnej powierzchni natarcia + około 3 zwoje gwintu</p>
		
		<p>- Podczas gwintowania otworów nieprzelotowych nie można dopuścić do kolizji czoła gwintownika i dna otworu</p> <p>- W przypadku maszyn sterowanych numerycznie z cyklem gwintowania synchronicznego zaleca się stosowanie oprawki do gwintowania z minimalną kompensacją osiową.</p> <p>- Stosowane prędkości skrawania powinny uwzględniać warunki zamocowania detalu oraz gwintownika, rodzaj obrabianego materiału, rodzaj oraz stan wykorzystywanej maszyny, a także warunki smarowania gwintownika</p>
50	Sprawdzenie poprawności gwintu	<p>- Po wykonaniu gwintu, należy poddać go kontroli sprawdzianem do gwintów (rozdział 7, str. 221) zgodnie z zaleceniami zawartymi w sekcji technicznej dotyczącej sprawdzianów.</p>
		

4.11. Rozwiązywanie problemów przy gwintowaniu.

Problem: Otwory nagwintowane zbyt luźne (część nieprzechodnia sprawdzianu wkręca się bardzo głęboko)	
Niewłaściwy gwintownik dla wykonywanego gwintu i obrabianego materiału.	Zastosować gwintownik przeznaczony do typu otworu gwintowanego i rodzaju materiału zgodnie z tabelą doboru znajdującą się w katalogu.
Zbyt wysoka prędkość gwintowania.	Zmniejszyć prędkość gwintowania. Zwiększyć ilość chłodziwa/środka smarującego.
Zimne naklejanie się materiału na flankach gwintownika.	Wymienić narzędzie na nowe. Zastosować gwintownik pokryty. Zwiększyć ilość chłodziwa/środka smarującego. Usunąć w gwintowniku zatarte zwoje.
Zapychanie rowków wiórowych.	Zastosować gwintownik z inną geometrią rowków (kąt). Możliwa konieczność zastosowania gwintowników kompletowych.
Zadzior szlifierski.	Usunąć zadzior szczotką drucianą.
Niewłaściwe zamocowanie lub umiejscowienie części obrabianej.	Zastosować uchwyt gwintownika z kompensacją poosiową i promieniową. Wyosiować i zamocować precyzyjnie element obrabiany.
Niewłaściwy posuw gwintownika.	Gwintować z kontrolowanym posuwem. Sprawdzić parametry maszyny CNC (program). Sprawdzić luz śruby pociągowej. Zastosować oprawkę kompensacyjną.
Problem: Otwory nagwintowane luźne (część nieprzechodnia sprawdzianu wkręca się)	
Zbyt wysoka tolerancja zastosowanego gwintownika w stosunku do wymaganej klasy gwintu.	Sprawdzić opis na gwintowniku i ustalić czy jest dostosowany do wykonania wymaganej klasy gwintu. W razie wątpliwości skontaktować się z doradcą.
Niewłaściwie wykonane ostrzenie gwintownika.	Ostrzenie gwintownika wymaga, żeby wszystkie szlifowane powierzchnie miały zachowaną geometrię nadaną przez producenta. Skontaktować się z doradcą w celu uzyskania instrukcji.
Problem: Nagwintowany otwór jest zbyt ciasny (strona przechodnia nie chce się wkręcić, lub podczas wkręcania zakleszcza się).	
Wybrany gwintownik ma geometrię nie pozwalającą na wielokrotne przeostrzenie.	Ograniczyć liczbę przeostrzeń gwintownika. Zastosować nowy gwintownik.
Część powierzchni gwintownika nie została odnowiona podczas ostrzenia.	Ponownie ostrzyć gwintownik. Zastosować nowy gwintownik.
Niewłaściwy gwintownik dla wykonywanego gwintu i obrabianego materiału.	Zastosować gwintownik przeznaczony do typu otworu gwintowanego i rodzaju materiału zgodnie z tabelą doboru znajdującą się w katalogu.
Zastosowany gwintownik ma zbyt mały wymiar nominalny (tolerancję).	Sprawdzić opis na gwintowniku i ustalić czy jest dostosowany do wykonania wymaganej klasy gwintu. W razie wątpliwości skontaktować się z doradcą.
Problem: Otwory nagwintowane rozszerzone u wejścia gwintu (pierwsze zwoje gwintu nadwymiarowe)	
Zbyt wysoka tolerancja zastosowanego gwintownika w stosunku do obrabianego otworu.	Sprawdzić opis na gwintowniku i ustalić czy jest dostosowany do wykonania wymaganej klasy gwintu. W razie wątpliwości skontaktować się z doradcą.
Niewłaściwie wykonane ostrzenie gwintownika.	Ostrzenie gwintownika wymaga, żeby wszystkie szlifowane powierzchnie miały zachowaną geometrię nadaną przez producenta. Skontaktować się z doradcą w celu uzyskania instrukcji.
Problem: Krótka żywotność gwintownika	
Wszystkie przyczyny wymienione w następnym tabeli „chropowaty i poszarpany gwint „.	Przeczytać informacje z następnym tabeli.
Utrata twardości gwintownika przez przegrzanie podczas ostrzenia.	Zmienić charakterystykę ściernicy. Zastosować chłodziwo podczas ostrzenia.
Utrata właściwości pokrycia po ostrzeniu gwintownika.	Repokrycie gwintownika. Sprawdzić cechy zastosowanej powłoki i jej użyteczność dla obróbki materiału gwintowanego.
Gwintowanie otworu utwardzonego na skutek procesu wiercenia.	Wymieniać lub częściej przeostrzać wiertło pod gwint. Sprawdzić prędkość i posuw wiertła w czasie wiercenia. Wyżarzyć element przed gwintowaniem.

Problem: Uszkodzenie ostrza gwintownika

Niewłaściwy gwintownik dla wykonywanego gwintu i obrabianego materiału.	Zastosować gwintownik przeznaczony do typu otworu gwintowanego i rodzaju materiału zgodnie z tabelą doboru znajdującą się w katalogu.
Rozmiar wiertła zbyt mały.	Zastosować właściwe wiertło pod gwint. Sprawdzić wymiar wiertła w katalogu (uwaga wymiary są inne dla gwintowników i dla wygniataków). W razie wątpliwości skontaktować się z doradcą.
Zbyt płytki otwór pod gwint.	Sprawdzić głębokość wywierconego otworu (wierćło podczas pracy mogło się wsunąć w oprawkę).
Brak otworu pod gwint.	Sprawdzić czy otwór istnieje w rzeczywistości (częsty problem w automatycznych liniach produkcyjnych lub wielowrzecionowych centrach obróbczych).
Zapychanie rowków wiórowych.	Zastosować gwintownik z inną geometrią rowków (kąt). Możliwa konieczność zastosowania gwintowników kompletowych.
Naklejanie się materiału na flankach gwintownika.	Wymienić narzędzie na nowe. Zastosować gwintownik pokryty. Zwiększyć ilość chłodziwa/środka smarującego. Usunąć w gwintowniku zatarte zwoje.
Przeciążenie zębów na nakroju gwintownika.	Zastosować gwintownik z dłuższym nakrojem. Zastosować gwintownik z większą liczbą zębów w celu rozłożenia obciążenia na nakroju.
Niewłaściwe zamocowanie lub umiejscowienie części obrabianej.	Zastosować uchwyt gwintownika z kompensacją poosiową i promieniową. Wyosiować i zamocować precyzyjnie element obrabiany.
Uderzenie gwintownika o dno otworu.	Zastosować oprawkę z kompensacją długości i sprzęgłem przeciążeniowym.
Gwintowanie materiałów twardych i o wysokiej wytrzymałości na rozciąganie.	Sprawdzić poprawność doboru gwintownika. Gwintowniki HSSE-PM i VHM mogą się okazać właściwsze niż HSSE.

Problem: Po gwintowaniu pozostaje chropowaty i poszarpany gwint

Niewłaściwy gwintownik dla wykonywanego gwintu i obrabianego materiału.	Zastosować gwintownik przeznaczony do typu otworu gwintowanego i rodzaju materiału zgodnie z tabelą doboru znajdującą się w katalogu.
Zbyt wysoka lub zbyt niska prędkość gwintowania.	Dostosować prędkość gwintowania. Zwiększyć ilość chłodziwa/środka smarującego dla zabezpieczenia skutków zmiany prędkości.
Naklejanie się materiału na flankach gwintownika.	Wymienić narzędzie na nowe. Zastosować gwintownik pokryty. Zwiększyć ilość chłodziwa/środka smarującego. Usunąć w gwintowniku zatarte zwoje.
Zapychanie rowków wiórowych.	Zastosować gwintownik z inną geometrią rowków (kąt). Możliwa konieczność zastosowania gwintowników kompletowych.
Zadzior szlifierski.	Usunąć zadzior szczotką drucianą.
Rozmiar wiertła zbyt mały.	Zastosować właściwe wiertło pod gwint. Sprawdzić wymiar wiertła w katalogu (uwaga wymiary są inne dla gwintowników i dla wygniataków). W razie wątpliwości skontaktować się z doradcą.
Niewłaściwe chłodzenie lub smarowanie podczas obróbki.	Dobrać chłodziwo zgodnie z zaleceniami w katalogu. Stosować właściwą ilość chłodziwa.
Przeciążenie narzędzia spowodowane skokiem gwintu, twardością materiału lub krótkim nakrojem.	Zastosować komplet gwintowników.

4.12. Regeneracja - Informacja o kątach natarcia

Grupa Materiałowa	Materiał	Oznaczenie	γ_p [°]
P	Stal	800	10 – 13
		FAN-1200	7 – 10
		1400	5 – 7
M	Stal nierdzewna	INOX	10 – 13
K	Żeliwo	GG	4 – 6
N	Materiały nieżelazne	GAL	7 – 9
			10 – 13
			4 – 6
S	Stopy żaroodporne i stopy tytanowe	1400-HT	5 – 7
H	Materiały twarde	HRC60	-5 – -4

5. WYGNIATAKI

5.1. Elementy konstrukcyjne wygniataka

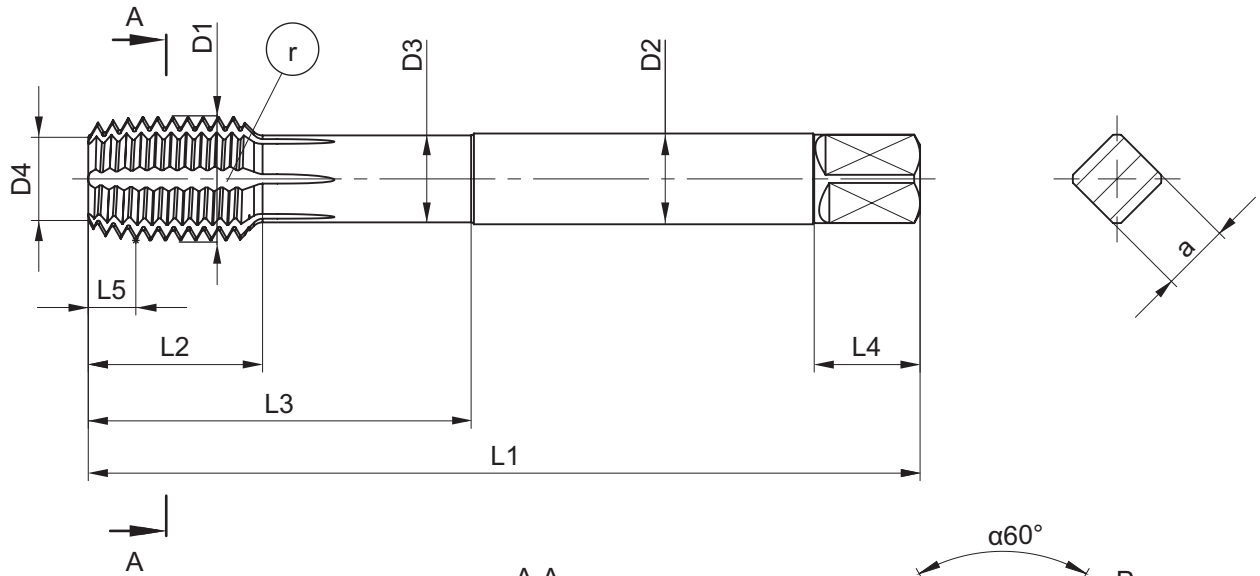

- L1- długość całkowita
- L2 - długość części roboczej
- L3 - długość użytkowa
- L4 - długość zabieraka kwadratowego
- L5 - długość części skrawającej (nakroju)
- $\varnothing D1$ - średnica znamionowa gwintu
- $\varnothing D2$ - średnica chwytu
- $\varnothing D3$ - średnica szyjki
- $\varnothing D4$ - średnica czołowa
- $\varnothing D5$ - średnica rdzenia

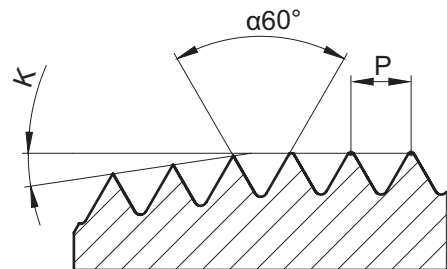
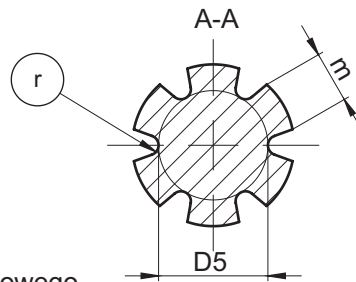

- r - rowek olejowy
- κ - kąt przystawienia (nakroju)
- α - kąt zarysu gwintu
- P - podziałka gwintu (skok)
- m - szerokość ostrza
- a - wielkość zabieraka kwadratowego

5.2. Rodzaje nakrojów wygniataków

Symbol rodzaju nakroju	Szkic	Długość nakroju wyrażona w ilości zwojów gwintu	Kąt nakroju
C		$2 \div 3 P$	$8,5^\circ$
E		$1,5 \div 2 P$	$11,5^\circ$

5.3. Oznaczenie i cechowanie wygniataków

Oznaczenie

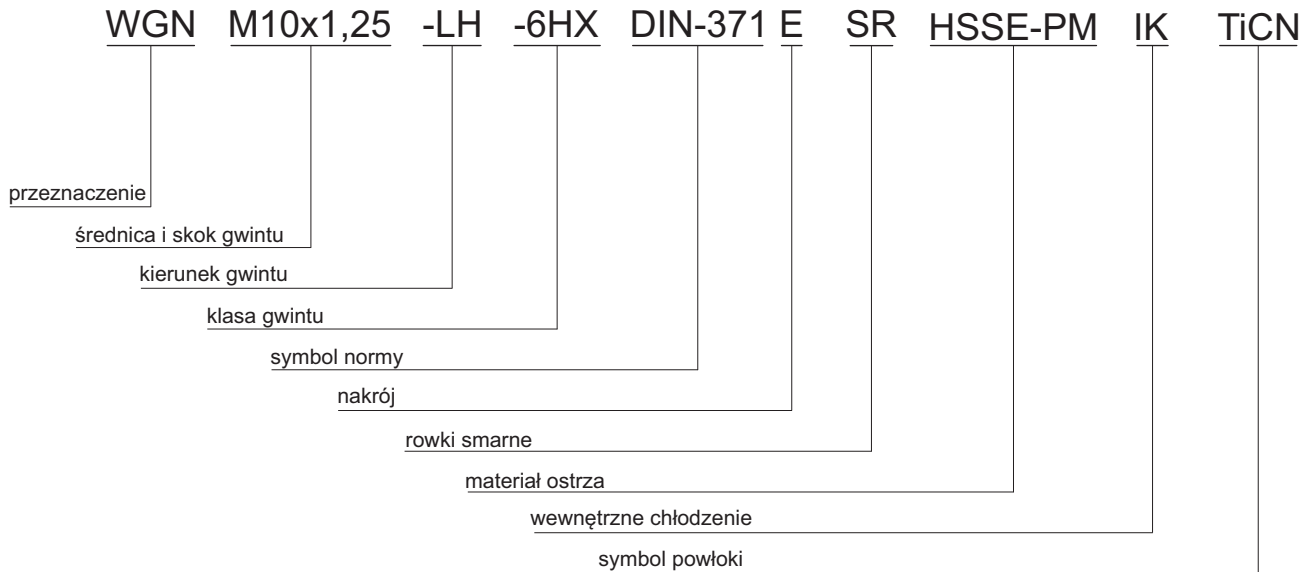

Cechowanie

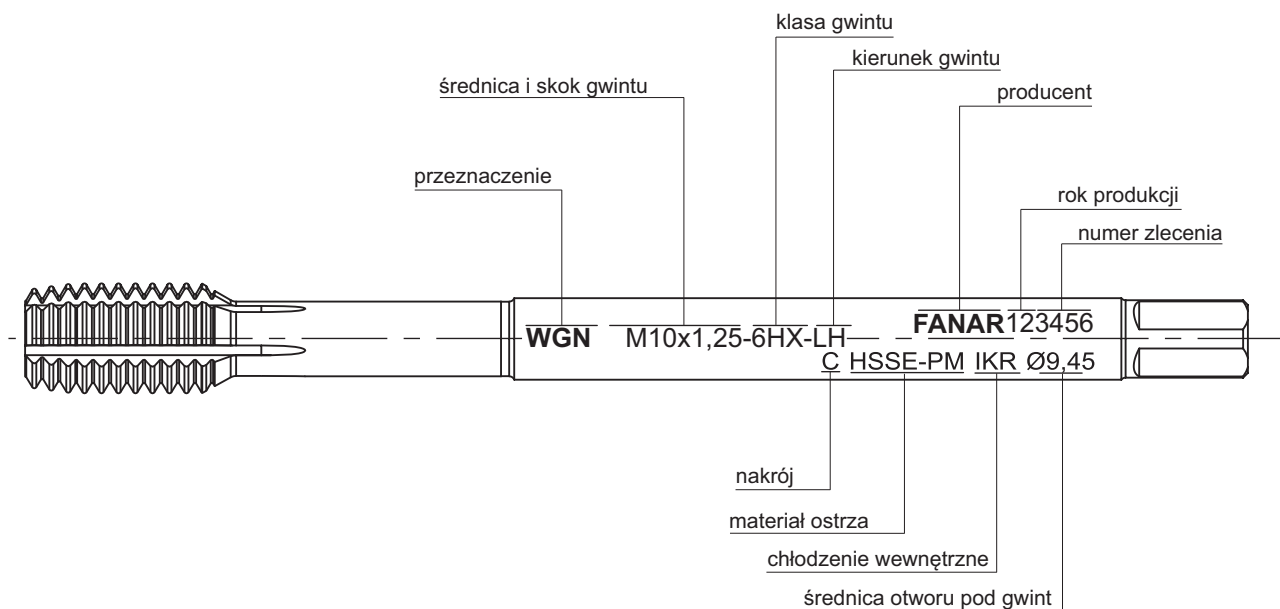

5.4. Różnica między gwintem nacinanym, a wygniatym

Proces wygniatania jest to obróbka bezwiórowa, gdzie materiał jest odciskany od przedmiotu obrabianego, gwint formowany jest przez odkształcenie plastyczne, bez konieczności odprowadzania wiórow. Materiał formowany jest na zimno, bez przerywania przebiegu włókien.



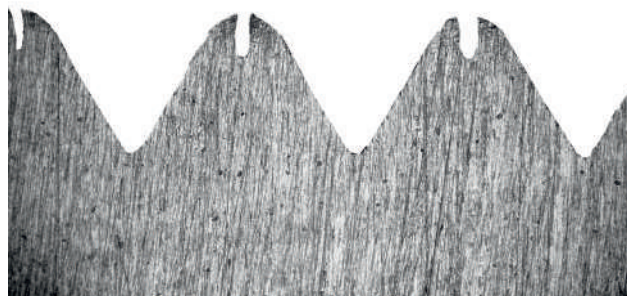

Gwint nacinany



Gwint wygniatany

Zalety wygniatania	Wady wygniatania
→ obróbka bezwiórowa	→ znacznie większe momenty wygniatania w porównaniu do nacinania
→ jedno narzędzie do otworów przelotowych i nieprzelotowych	→ niecałkowite uformowanie rdzenia gwintu
→ możliwe gwintowanie głębokich otworów 4 x D	→ nośność gwintu stanowi ok 80% nośności gwintu nacinanego, ale uzyskujemy znacznie większą wytrzymałość
→ wysoka wytrzymałość gwintu, szczególnie na powierzchniach bocznych gwintu	→ ograniczony obszar zastosowania do materiałów plastycznych
→ lepsza powierzchnia gwintu	→ wyższa tolerancja wykonywania gwintu
→ brak błędów podziału podziałki i zarysu gwintu	→ metoda niezalecana w przemyśle spożywczym i farmaceutycznym
→ możliwość gwintowania ze znacznie wyższymi parametrami obróbki, ponieważ formowalność większości materiałów wzrasta wraz z prędkością formowania, nie ma to negatywnego wpływu na trwałość narzędzia	
→ duża sztywność narzędzia zmniejsza ryzyko jego uszkodzenia	

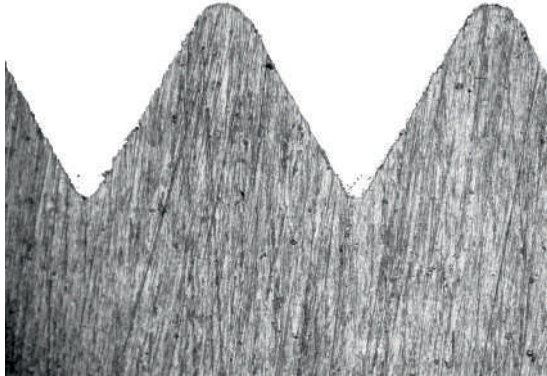
5.5. Rozwiązywanie problemów przy wygniataniu

Problem	Rozwiązanie
<p data-bbox="172 302 453 331">Niepełny zarys gwintu</p> 	<p data-bbox="831 360 1366 454">Zmniejszyć średnicę wiertła pod gwint lub zastosować średnicę wiertła zgodną z tabelą doboru dla wygniataków str. 336.</p>
<p data-bbox="172 784 871 813">Przeformowany zarys gwintu, za mała średnica rdzenia</p> 	<p data-bbox="831 844 1366 938">Zwiększyć średnicę wiertła pod gwint lub zastosować średnicę wiertła zgodną z tabelą doboru dla wygniataków str. 336.</p>
<p data-bbox="172 1265 1019 1294">Niska jakość powierzchni gwintu, wyrwania na powierzchni gwintu</p>	<p data-bbox="831 1317 1394 1503"> Poprawa smarowania: zastosować wygniatak z rowkami olejowymi Zwiększyć ilość chłodziwa/środka smarującego Zastosować olej jako środek smarujący Zastosować wygniatak pokryty </p>
<p data-bbox="172 1581 419 1610">Złamanie narzędzia</p> 	<p data-bbox="831 1635 1394 1850"> Zwiększyć otwór pod gwint Zwiększyć ilość chłodziwa/środka smarującego Zastosowanie pokrycia zapobiegającego przywieraniu obrabianego materiału Sprawdzić zgodność obrabianego materiału z zaleceniami co do plastyczności i twardości </p>

6.3. Oznaczanie i cechowanie narzynek

Marking

Przykład: narzynka maszynowa wysokowydajna wg normy DIN-EN 22 568 do gwintu M12, tolerancja gwintu 6g, do stali nierdzewnej

Oznaczenie: podawane w zamówieniach, fakturach, specyfikacjach, na opakowaniach

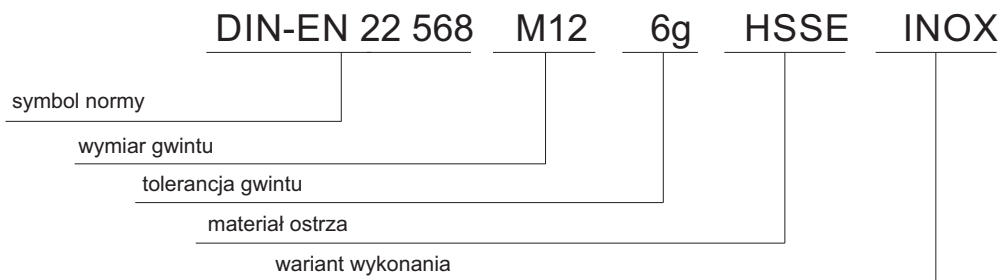



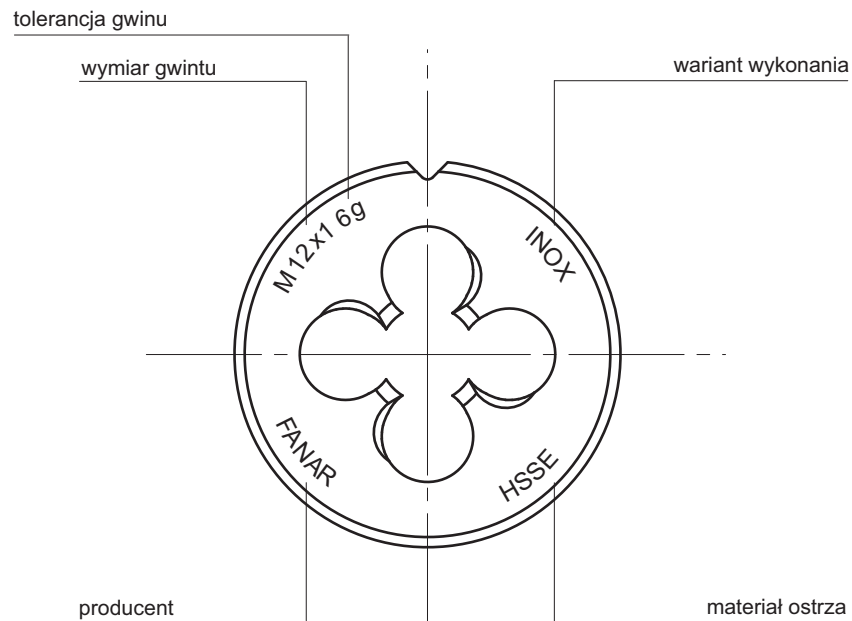

Cechowanie



6.4. Tolerancje gwintu nacinanego

Narzynki w wydaniu katalogowym przeznaczone są do nacinania najczęściej występującej podstawowej dla danego rodzaju gwintu tolerancji: dla gwintu metrycznego 6g, dla gwintów UNC, UNF itd. 2A. Na życzenie możemy wykonać narzynki do innych niż powyższe pół tolerancji np. dla gwintów metrycznych: 4h dla gwintów ciasnych, 6e dla gwintów pod cienkie powłoki galwaniczne.

6.5. Grupy narzędzi według zastosowania

800 	Do obróbki stali konstrukcyjnych oraz staliwa o $R_m \leq 800 \text{ MPa}$.
800 SPN 	Do obróbki stali konstrukcyjnych oraz staliwa o $R_m \leq 800 \text{ MPa}$. Uzyskiwana lepsza jakość nacinanego gwintu, do stosowania na automatach tokarskich.
Ms 	Do obróbki mosiądzu i brązu krótko wiórowego.
INOX 	Do obróbki stali nierdzewnych, aluminium odlewniczego oraz żeliwa sferoidalnego.

6.6. Rodzaje nakrojów narzynek

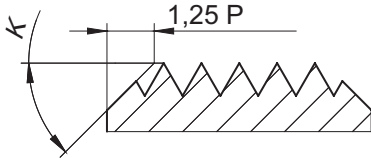
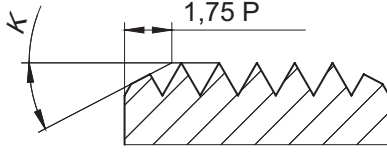
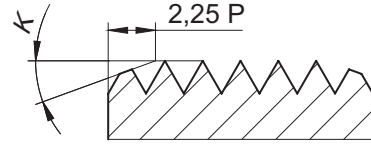
Długość	Zastosowanie	Szkic	Kąt
1,25 P	Ms		45°
1,75 P	800		27,5°
2,25 P	INOX		20°

7. SPRAWDZIANY

7.1. Budowa sprawdzianów

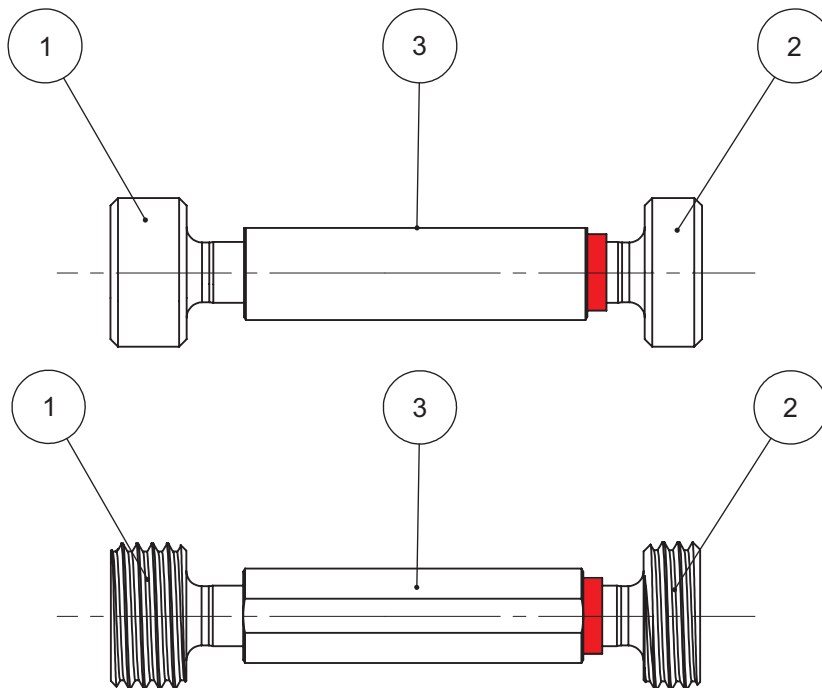

- 1 - tłoczek przechodni
- 2 - tłoczek nieprzechodni
- 3 - rękojeść

7.2. Rodzaje sprawdzianów

7.2.1 SPRAWDZIANY NPT

Splaszczanie równo z płaszczyzną detalu

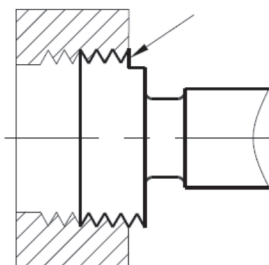

Głębokość bazowa

Splaszczanie 1 zwój (obrót) powyżej płaszczyzny detalu

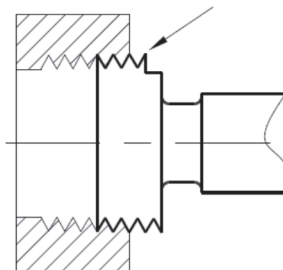

Minimalna głębokość gwintowania



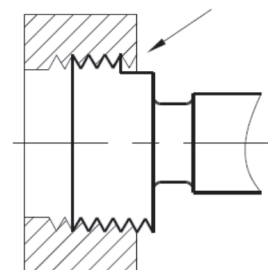

Splaszczanie 1 zwój (obrót) poniżej płaszczyzny detalu



Maksymalna głębokość gwintowania

7.2.2 SPRAWDZIANY R, Rc/Rp

Gwint rurowy do połączeń ze szczelnością uzyskiwaną na gwincie wg PN-EN 10226-1, PN-EN 10226-2 (ISO7-1:2000). Weryfikacja sprawdzianami granicznymi wg PN-EN 10226-3 (ISO-7-2:2000)

<p style="text-align: center;">Sprawdzian nr 1</p> 	<p>Sprawdzian gwintowy stożkowy trzpieniowy o zarysie pełnym.</p> <p>Ten sprawdzian trzpieniowy ma gwint stożkowy o zbieżności 1:16, o zarysie pełnym i jest przeznaczony do sprawdzania średnicy zewnętrznej (D) i podziałowej (D_2) w płaszczyźnie podstawowej gwintów walcowych wewnętrznych (Rp) i gwintów stożkowych wewnętrznych (Rc).</p>
<p style="text-align: center;">Sprawdzian nr 2</p> 	<p>Sprawdzian gwintowy stożkowy trzpieniowy o zarysie pełnym z wybraniem.</p> <p>Ten sprawdzian trzpieniowy ma gwint stożkowy o zbieżności 1:16, o zarysie pełnym z wybraniem i jest przeznaczony do sprawdzania średnicy zewnętrznej (D) i podziałowej (D_2) płaszczyźnie podstawowej oraz długości akomodacji walcowych wewnętrznych (Rp) i gwintów stożkowych wewnętrznych (Rc).</p> <p>¹ Długość akomodacji: Odległość na przedmiocie z gwintem wewnętrznym od czoła przedmiotu do pierwszej przeszkody, którą podczas montażu napotka przedmiot z gwintem zewnętrznym</p>
<p style="text-align: center;">Sprawdzian nr 3</p> 	<p>Sprawdzian gwintowy walcowy pierścieniowy o zarysie pełnym.</p> <p>Ten sprawdzian pierścieniowy ma gwint o zarysie pełnym i jest przeznaczony do sprawdzania średnicy wewnętrznej (d_1) i średnicy podziałowej (d_2) w płaszczyźnie podstawowej gwintu stożkowego (R).</p>
<p style="text-align: center;">Sprawdzian nr 4</p> 	<p>Sprawdzian gładki stożkowy pierścieniowy.</p> <p>Ten sprawdzian pierścieniowy ma gładki stożek o zbieżności 1:16 i jest przeznaczony do sprawdzania średnicy zewnętrznej (d) i długości użytecznej gwintów stożkowych zewnętrznych (R).</p>
<p style="text-align: center;">Sprawdzian nr 5</p> 	<p>Przeciwsprawdzian gwintowy stożkowy trzpieniowy o zarysie modyfikowanym.</p> <p>Przeciwsprawdzian ten jest przeznaczony do sprawdzania wymiarów sprawdzianu gwintowego walcowego pierścieniowego o zarysie pełnym (sprawdzian nr3) podczas jego wykonywania i kontroli zużycia sprawdzianu pierścieniowego.</p>

7.3. Sprawdzanie otworów

Do sprawdzania otworów przelotowych i nieprzelotowych stosuje się sprawdziany tłoczkowe przechodnie i nieprzechodnie. Sprawdzian przechodni powinien wsunąć się w otwór pod wpływem lekkiego ręcznego nacisku lub pod własnym ciężarem. Niedopuszczalne jest wciskanie sprawdzianu siłą, gdyż grozi to jego zakleszczeniem. Sprawdzian nieprzechodni nie powinien wsunąć się w otwór.

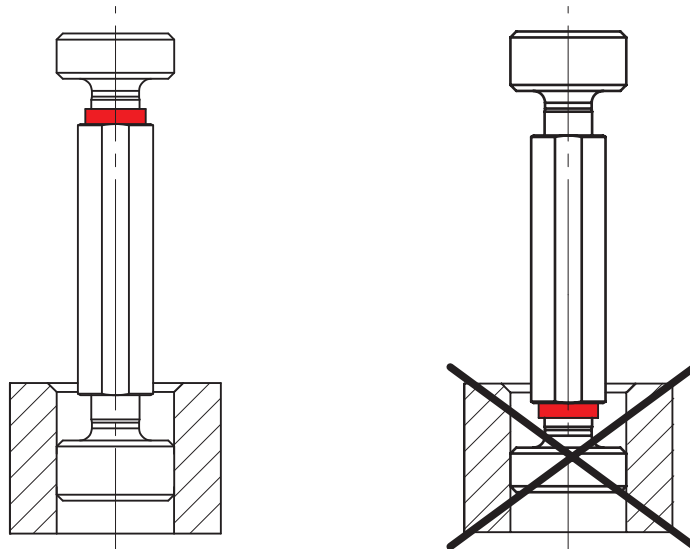

Sprawdzanie gwintów wewnętrznych walcowych

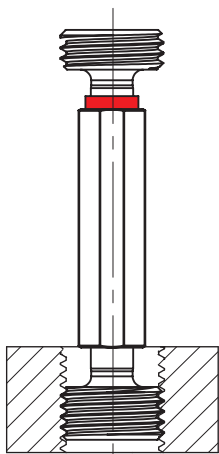

Do sprawdzania gwintów wewnętrznych stosuje się sprawdziany gwintowe trzpieniowe przechodnie i nieprzechodnie. **Sprawdzianem gwintowym trzpieniowym przechodnim** sprawdza się wirtualny wymiar gwintu wewnętrznego przez sprawdzenie wymiaru dolnego średnicy podziałowej. Sprawdzian przechodni powinien przy ręcznym wkręcaniu bez nadmiernego wysiłku wkręcać się na całą długość gwintu. Gwint nie spełnia wymagań, gdy wkręcenie sprawdzianu jest niemożliwe.

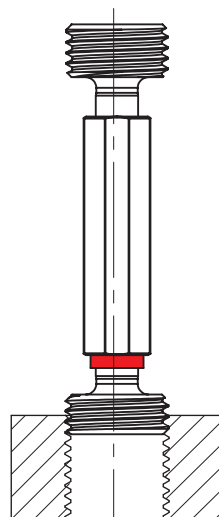

Sprawdzianem gwintowym trzpieniowym nieprzechodnim sprawdza się czy średnica podziałowa gwintu przekracza górny wymiar graniczny. Sprawdzian nieprzechodni przy ręcznym wkręcaniu bez nadmiernego wysiłku może wkręcać się w gwint nie **więcej niż na dwa zwoje**. Wkręcenie na więcej niż dwa zwoje gwintu powoduje nie spełnienie wymagań.

7.4. Stosowanie sprawdzianów i sprawdzanie gwintów

Sprawdzanie gwintów wewnętrznych stożkowych (Rc) i walcowych (Rp)

Etap 1: Sprawdzian gwintowy stożkowy trzpieniowy (**Sprawdzian nr 1**) wkręca się ręcznie mocno w gwint wewnętrzny. Gwint wewnętrzny jest wykonany w granicach tolerancji, jeśli czoło przedmiotu z gwintem znajduje się między czołami progów lub pokrywa się z jednym z czoł progów sprawdzianu.

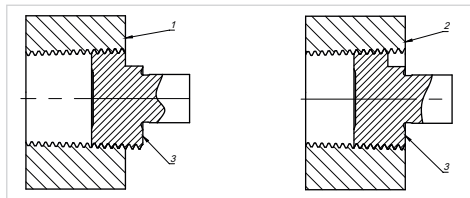

Objaśnienia:

- 1 - czoło przedmiotu pokrywa się z progiem tolerancyjnym sprawdzianu,
- 2 - czoło przedmiotu pokrywa się z czołem sprawdzianu
- 3 - sprawdzian nr 1

Etap 2: Sprawdzian gwintowy trzpieniowy z wybraniem (**Sprawdzian nr 2**) wkręca się ręcznie mocno w gwint wewnętrzny. Gwint wewnętrzny jest wykonany w granicach tolerancji, jeśli czoło przedmiotu z gwintem znajduje się między czołami progów lub pokrywa się z jednym z czoł progów sprawdzianu.

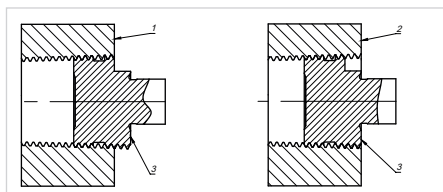

Objaśnienia:

- 1 - czoło przedmiotu pokrywa się z progiem tolerancyjnym sprawdzianu,
- 2 - czoło przedmiotu pokrywa się z czołem sprawdzianu
- 3 - sprawdzian nr 2

Uwaga 1 : Jeśli przedmiot został odrzucony przez sprawdzian nr2, lecz przyjęty przez sprawdzian nr 1, może wskazywać to na brak odpowiedniej długości akomodacji.

Uwaga 2 : Zmienność względnego położenia progów sprawdzianów nr 1 i nr 2 przekraczająca 0,5xP ale nie większa niż 1xP jest dopuszczalna, jeśli wytwórca i nabywca uzgodnią, że zastosowane do montażu szczeliwo skompensuje zwiększone różnice wyników sprawdzenia.

Uwaga 3 : W przypadku gwintów Rp, jeśli głębokość ścieżki na średnicy podziałowej odbiega od 0,5xP, wynik sprawdzenia może być znacznie zakłócony.

Sprawdzanie gwintów zewnętrznych stożkowych (R)

Etap 1: Sprawdzian gwintowy walcowy pierścieniowy (**Sprawdzian nr 3**) wkręca się ręcznie mocno na gwint zewnętrzny. Gwint zewnętrzny jest wykonany w granicach tolerancji, jeśli czoło przedmiotu z gwintem znajduje się między czołami progów lub pokrywa się z jednym z czoł progów sprawdzianu.

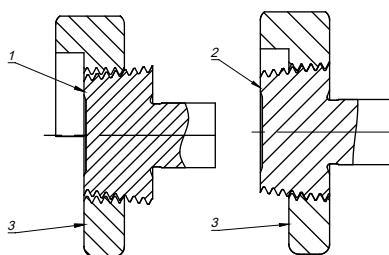

Objaśnienia:

- 1 - czoło przedmiotu pokrywa się z progiem tolerancyjnym sprawdzianu,
- 2 - czoło przedmiotu pokrywa się z czołem sprawdzianu
- 3 - sprawdzian nr 3

Etap 2: Sprawdzan gładki stożkowy (**Sprawdzian nr 4**) osadza się ręcznie mocno na gwincie zewnętrznym. Gwint zewnętrzny jest wykonany w granicach tolerancji, jeśli czoło przedmiotu z gwintem znajduje się między czołami progów lub pokrywa się z jednym z czoł progów sprawdzianu i dna bruzd wszystkich zwojów gwintu w obszarze pokrytym przez sprawdzian są w pełni ukształtowane

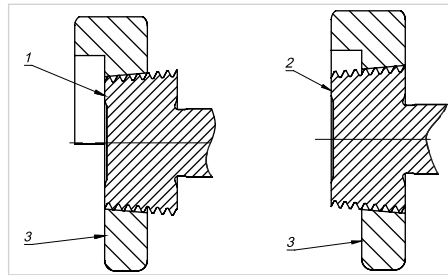

Objaśnienia:

- 1 - czoło przedmiotu pokrywa się z progiem tolerancyjnym sprawdzianu,
- 2 - czoło przedmiotu pokrywa się z czołem sprawdzianu
- 3 - sprawdzian nr 4

Uwaga: Zmienność względnego położenia progów sprawdzianów nr 3 i nr 4 przekraczająca 0,5xP, ale nie większa niż 1xP jest dopuszczalna jeśli wytwórca i nabywca uzgodnią, że zastosowane do montażu szczeliwo skompensuje zwiększone różnice wyników sprawdzenia.

Sprawdzanie zużycia sprawdzianów gwintowych trzpieniowych stożkowych (Sprawdzian nr 1, Sprawdzian nr 2)

Średnicę podziałową sprawdzianów trzpieniowych z gwintem stożkowym można sprawdzać przeciwsprawdzianem gwintowym walcowym pierścieniowym o zarysie modyfikowanym (**Sprawdzian nr 6**). Średnicę zewnętrzną sprawdzianów gwintowych stożkowych trzpieniowych należy sprawdzać za pomocą pomiarów bezpośrednich.

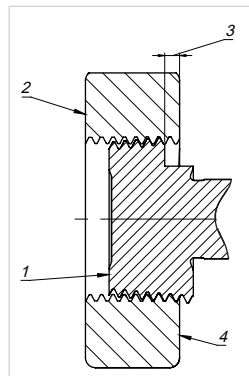

Objaśnienia:

- 1 - sprawdziany nr 1 i nr 2,
- 2 - sprawdzian nr 6,
- 3 - odległość od czoła progów sprawdzianu trzpieniowego do czoła przeciwsprawdzianu pierścieniowego powinna być l_{13} (Patrz PN-EN 10226-3:2005 tab.16)
- 4 - oznakowane czoło wskazujące położenie płaszczyzny podstawowej

Sprawdzanie zużycia sprawdzianów gwintowych walcowych pierścieniowych (Sprawdzian nr 3)

Sprawdziany gwintowe walcowe pierścieniowe o zarysie pełnym należy sprawdzać na średnicy podziałowej przeciwsprawdzianem gwintowym stożkowym, trzpieniowym o zarysie modyfikowanym (**Sprawdzian nr 5**). Średnicę wewnętrzną należy sprawdzić za pomocą pomiarów bezpośrednich.

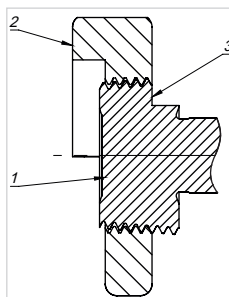

Objaśnienia:

- 1 - sprawdziany nr 5,
- 2 - sprawdzian nr 3,
- 3 - odległość od czoła progów przeciwsprawdzianu trzpieniowego do czoła przeciwsprawdzianu pierścieniowego powinna być l_{14} (Patrz PN-EN 10226-3:2005 tab.16)
- 4 - oznakowane czoło wskazujące położenie płaszczyzny podstawowej

8. WIERTŁA

8.1. Elementy konstrukcyjne wiertła

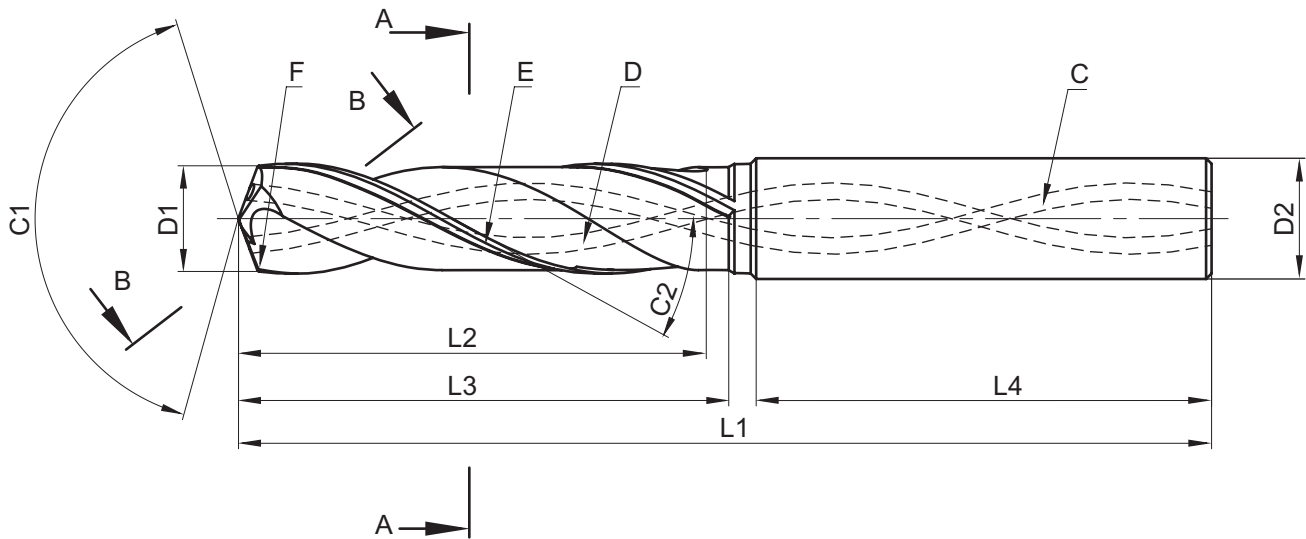

- A - część chwytowa
- B - część robocza
- C - kanał doprowadzający chłodziwo
- D - rowek wiórowy
- E - łysinka (pomocnicza powierzchnia przyłożenia)
- F - powierzchnia natarcia
- G - pierwotna powierzchnia przyłożenia
- H - wtórna powierzchnia przyłożenia
- I - korekta ścinu
- J - ścin

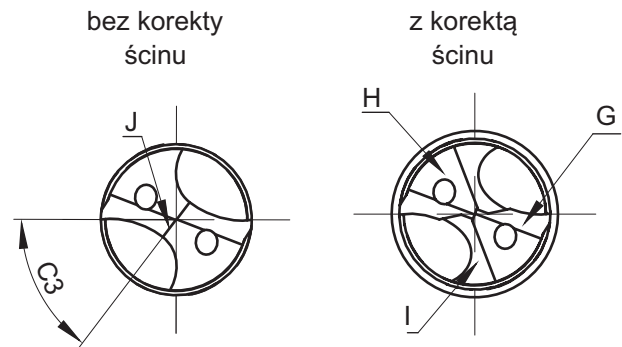

- L1 - długość całkowita
- L2 - długość rowków wiórowych
- L3 - długość łysinki
- L4 - długość chwytu
- D1 - średnica części roboczej
- D2 - średnica chwytu
- D3 - średnica rdzeniowa
- D4 - rozstaw kanałów chłodzących
- D5 - średnica kanałów chłodzących
- C1 - kąt wierzchołkowy
- C2 - kąt pochylenia rowka wiórowego
- C3 - kąt ścinu
- C4 - kąt przyłożenia
- C5 - kąt pierwotnej powierzchni przyłożenia
- C6 - kąt wtórnej powierzchni przyłożenia
- G1 - szerokość łysinki
- G2 - opuszczenie łysinki
- B - szerokość ostrza (pióra)

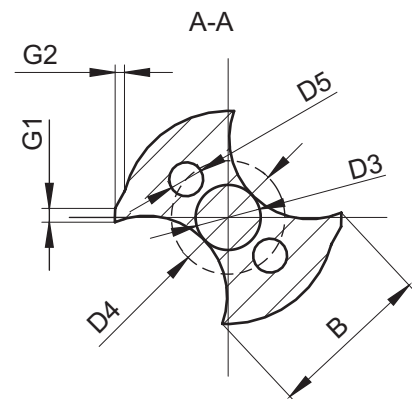

B-B

Formy powierzchni przyłożenia

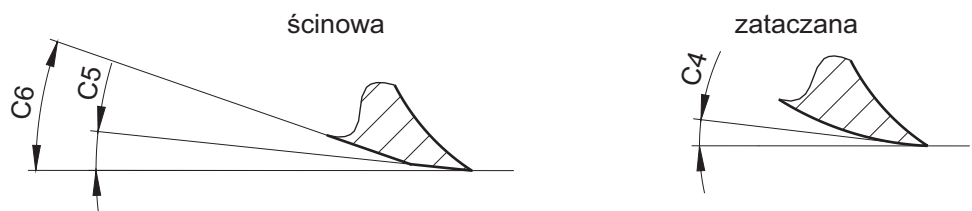

8.2. Warunki chłodzenia i smarowania

Stosowanie chłodziwa:

- Jest wskazane gdy głębokość wiercenia jest przynajmniej dwukrotnie większa od średnicy.
- Jest niezbędne przy głębokościach pięciokrotnie większych od średnicy wiertła
- Przy zewnętrznym chłodzeniu należy podawać chłodziwo nie tylko pod odpowiednim ciśnieniem, ale również w odpowiedni sposób.

Metody podawania chłodziwa:

Wewnętrzne:

- Powinno być stosowane zawsze, gdy głębokość otworu jest przynajmniej trzykrotnie większa od średnicy.
- Chłodzenie wewnętrzne jest zawsze zalecane w celu uniknięcia blokowania się wiórów.

Zewnętrzne:

- Aby poprawić usuwanie wiórów, przynajmniej jedna dysza chłodziwa (dwie, jeśli wiertło jest nieruchome) powinna być skierowana blisko osi narzędzia.
- Chłodzenie zewnętrzne pomaga uniknąć tworzenia się narostów na krawędziach z uwagi na obniżenie temperatury krawędzi.
- Dopuszcza się chłodzenie zewnętrzne przy materiałach dających krótki wiór.

8.3. Problemy i ich rozwiązywanie

Problem: Narost na krawędziac	
Zbyt mała prędkość skrawania	Zwiększyć prędkość skrawania
Zbyt wysoka temperatura krawędzi narzędzia	Doprowadzić chłodzenie
Zbyt duży ujemny kąt natarcia	Naostrzyć krawędź skrawającą
Ścieranie się pokrycia	Pokryć część roboczą narzędzia
Zbyt mała ilość oleju w chłodziwie	Zwiększyć ilości oleju w chłodziwie
Problem: Wykruszenia naroży	
Zbyt duże bicie	Zastosować oprawkę o większej precyzji mocowania
Zbyt duży posuw	Zmniejszyć posuw
Przerywany proces skrawania	Zmniejszenie posuwu przy wyjściu z materiału
Niewystarczająca ilość chłodziwa (pękanie termiczne)	Sprawdzić ciśnienie chłodziwa
Mała sztywność układu OUPN	Sprawdzić sztywność zamocowania narzędzia w oprawce
Problem: Nadmierne zużycie krawędzi skrawającej	
Zbyt duża prędkość skrawania	Zmniejszyć prędkość skrawania
Zbyt mały posuw	Zwiększyć posuw / zwiększyć kąt przyłożenia
Zbyt miękki materiał	Dobrać narzędzie odpowiednie do obrabianego materiału
Zbyt mała ilość chłodziwa	Sprawdzić ciśnienie chłodziwa i ustawienie dysz

Problem: Wykruszenia krawędzi skrawającej

Zbyt duże bicie	Zastosować oprawkę o większej precyzji mocowania
Niestabilne warunki skrawania	Sprawdzić parametry skrawania
Krytyczne zużycie narzędzia	Częściej wymieniać narzędzie
Zbyt twardy materiał	Dobrać narzędzie odpowiednie do obrabianego materiału

Problem: Ścieranie się łysinki

Zbyt duże bicie	Zastosować oprawkę o większej precyzji mocowania
Niskie ciśnienie chłodziwa	Używać czystego oleju albo emulsji o większej zawartości oleju
Zbyt wysoka prędkość skrawania	Zmniejszyć prędkość skrawania
Nalepianie się materiału obrabianego	Dobrać narzędzie odpowiednie do obrabianego materiału

Problem: Zużycie wierzchołka (ściny)

Zbyt niska prędkość skrawania	Zwiększyć prędkość skrawania
Zbyt duży posuw	Zmniejszyć posuw
Zbyt mały ścin	Sprawdzić wymiary
Drgania narzędzia	Zmniejszyć długość niepodpartą

Problem: Odkształcenie plastyczne

Zbyt duża prędkość skrawania	Zmniejszyć prędkość skrawania
Zbyt duży posuw	Zmniejszyć posuw
Słabe doprowadzenie chłodziwa	Sprawdzić ciśnienie chłodziwa i ustawienie dysz
Zbyt mała sztywność układu OUPN	Zastosować wiertło VHM

Problem: Odkształcenie plastyczne

Zbyt duża prędkość skrawania	Zmniejszyć prędkość skrawania
Zbyt duży posuw	Zmniejszyć posuw
Słabe doprowadzenie chłodziwa	Sprawdzić ciśnienie chłodziwa i ustawienie dysz
Zbyt mała sztywność układu OUPN	Zastosować wiertło VHM

Problem: Ścieranie się powłoki z krawędzi

Zbyt duże tarcie	Stosować chłodziwo o wższej zawartości oleju lub dodatków
Skośne wyjście	Zmniejszyć posuw na wyjściu
Nalepianie się materiału obrabianego	Zmniejszyć liczbę regeneracji narzędzia

Problem: Zator wiórów

Zbyt mała prędkość skrawania	Zwiększyć prędkość skrawania
Zbyt duży posuw	Zmniejszyć posuw
Zbyt małe rowki wiórowe	Dobrać narzędzie o odpowiedniej geometrii
Słabe wypłukiwanie wiórów	Zastosować chłodzenie wewnętrzne

9. OPRAWKI MASZYNOWE

9.1. Oprawki do gwintowania synchronicznego

MASTERSYNC

Zasady działania

Ideą MasterSYNC jest zastosowanie elementu sprężystego, który zapewnia osiowe i promieniowe kompensowanie nieuniknionych rozbieżności pomiędzy obrotami wrzeciona, a rzeczywistym skokiem gwintownika oraz zmniejszenie siły wzdłużnej działającej na gwintownik. Rezultatem jest zwiększenie żywotności gwintownika i poprawa jakości gwintu.

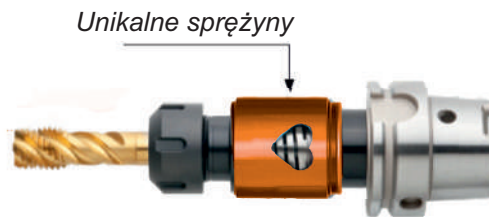

Poprzez ograniczenie kompensacji osiowej i sił skręcających działających na sprężyny, otwory mogą być gwintowane bez narażania oprawki MasterSYNC na zmęczenie, odkształcenie lub zniszczenie.

Moment obrotowy jest przekazywany przez sworznie napędowe - nie poprzez sprężyny.

Osiowa mikrokompensacja jest ściśle ograniczona (zabezpieczona mechanicznie)

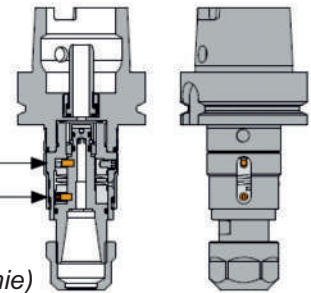

Wewnętrzne doprowadzenie chłodziwa i MQL

Oprawki z wewnętrznym doprowadzeniem chłodziwa mogą pracować z ciśnieniem 80bar bez wpływu na kompensację osiową.

Oprawki MQL przystosowane są do pracy z minimalną ilością chłodziwa.

IK

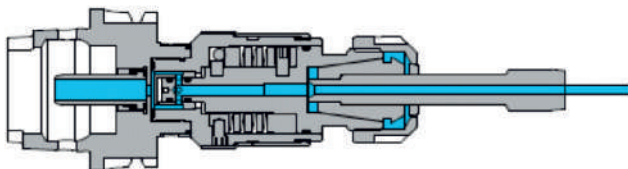

Wewnętrzne chłodzenie wysokim ciśnieniem ze zwiększoną prędkością przepływu

MQL

Śruba ustawcza

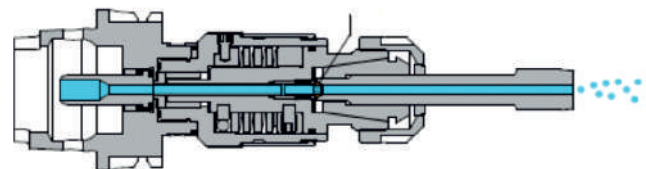

System MQL (Minimum Quantity Lubrication) - smarowanie minimalną ilością chłodziwa

9.2. Zabieraki ze sprzęgłem przeciążeniowym

ZALECANE WARTOŚCI USTAWIENIA MOMENTÓW OBROTOWYCH PRZY GWINTOWANIU MATERIAŁU O WYTRZYMAŁOŚCI $R_m=1000\text{MPa}$

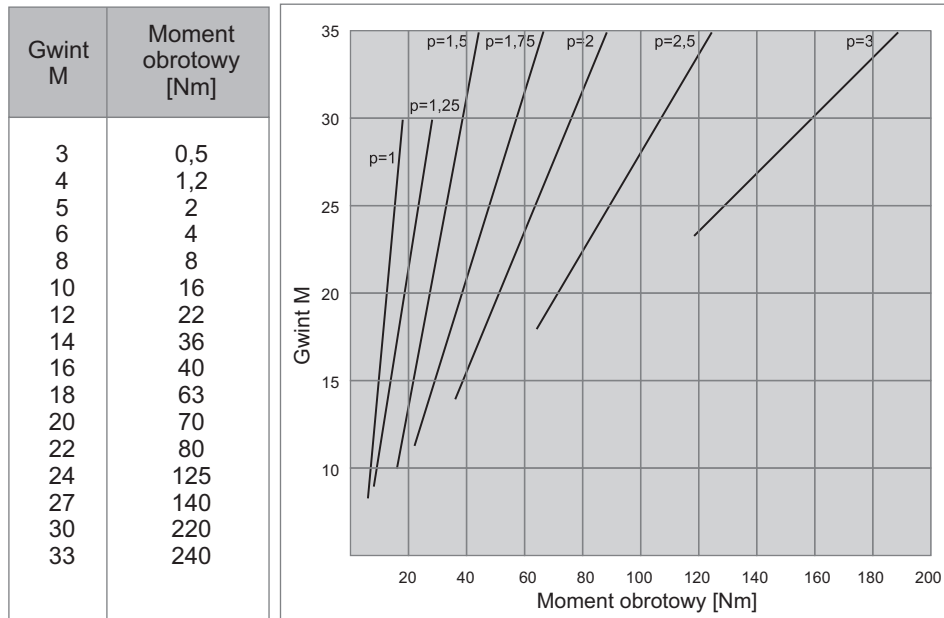

Podane wartości są orientacyjne i mogą się różnić w zależności od konkretnych warunków pracy

9.3. Mocowanie w tulejkach ER

BICIE CHWYTU NARZĘDZIA ZAMOCOWANEGO W TULEJCE ER

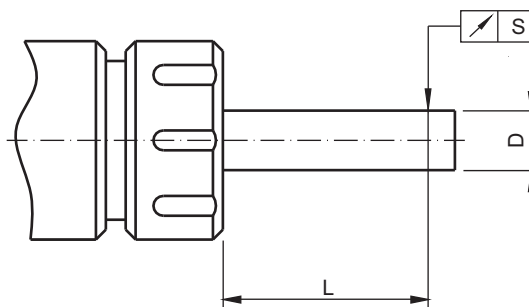

D	L	S
1-1,6	6	0,015
1,6-3	10	0,015
3-6	16	0,015
6-10	25	0,015
10-18	40	0,020
18-26	50	0,020
26-40	60	0,020

9.4. Wyważenie oprawek

Pojęcie niewyważenia

Niewyważenie jest to przesunięcie środka ciężkości masy wirującej od jej osi obrotu.

W skład masy wirującej wchodzi: wrzeciono maszyny, oprawka, elementy pośrednie (tulejki), inne elementy dodatkowe oprawek (nakrętki) oraz narzędzie.

Przyczyną niewyważenia jest niesymetryczność geometryczna, tolerancja wykonania, błędy zamocowania itp.

Niewyważenie powoduje drgania układu, które przenosząc się na narzędzie powodują obniżenie jego trwałości oraz pogorszenie jakości obróbki.

W celu ograniczenia niewyważenia do akceptowalnego poziomu należy zminimalizować luzy na wrzecionie oraz stosować właściwe oprawki i narzędzia. Do najbardziej wymagających aplikacji może okazać się konieczne wyważenie nie tylko oprawek, ale również narzędzi.

Wyważanie

Wyważanie polega na zmniejszaniu niewyważenia poprzez przesunięcie środka masy wirującej w kierunku osi obrotu. Odbywa się to poprzez zapewnienie właściwej geometrii oraz dodawanie lub ujmowanie mas dodatkowych. Cel ten można osiągnąć jedynie do pewnego stopnia, gdyż zawsze pozostanie niewyważenie resztkowe.

Klasy dokładności wyważenia

Z punktu widzenia ekonomicznego nie jest opłacalne zbytne zaostrzenie wymagań co do wyważenia masy wirującej. W celu osiągnięcia pewnego kompromisu pomiędzy aspektami technicznymi i ekonomicznymi wprowadzono normą ISO 1940 klasy dokładności wyważenia. Określono w niej typy zastosowań dla poszczególnych klas, i tak:

- klasa G6,3 przeznaczona jest dla części maszyn i obrabiarek ogólnego zastosowania,
- klasa G2,5 przeznaczona jest dla wysokoobrotowych części maszyn.

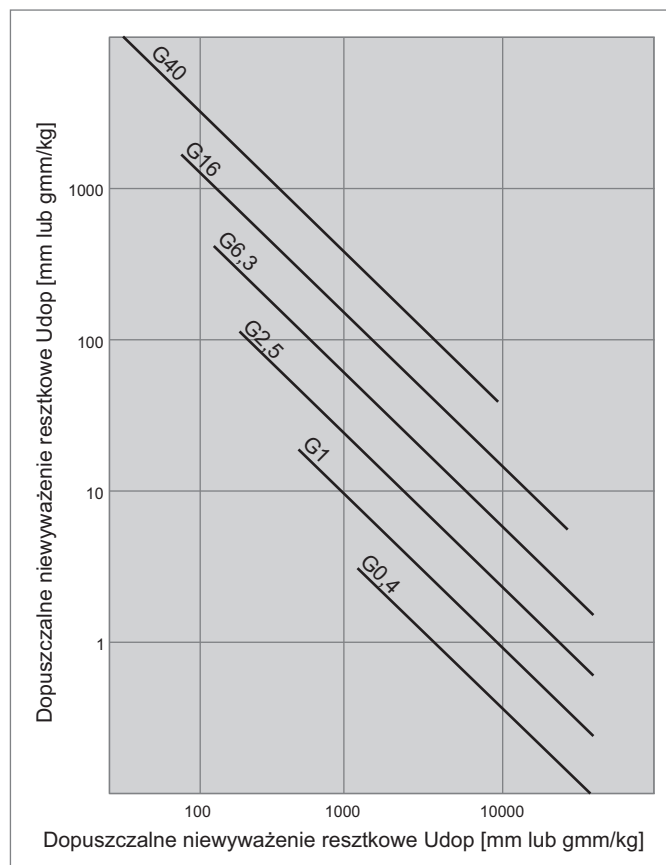

9.5. Chwyty oprawek

TR wg DIN-6327

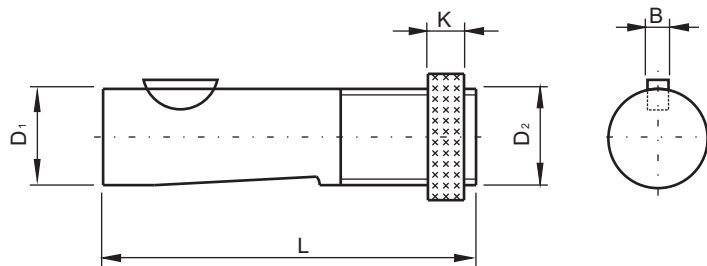

Chwył	D ₁	D ₂	L	B	K
TR20	20	TR20x1,5	88	5	12
TR28	28	TR28x2	95	6	12
TR36	36	TR36x2	118	8	14
TR48	48	TR48x2	144	10	18

Charakterystyka:

- Oprawki wykonane ze stali niklowo-chromowo-molibdenowej, nawęglane i hartowane na 58HRC
- Chwył precyzyjnie szlifowany w tolerancji g5

ISO wg DIN-69871 A

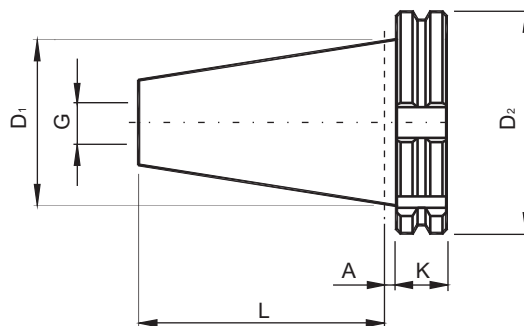

Stożek	D ₁	D ₂	L	A	K	G
ISO30	31,75	50,00	47,80	3,2	15,9	M12
ISO40	44,45	63,55	68,40	3,2	15,9	M16
ISO50	69,85	97,50	101,75	3,2	15,9	M24

Wersje wykonania:

- DIN-69871 A - chwył bez wewnętrznego chłodzenia
- DIN-69871 AD - z otworem centralnym
- DIN-69871 AD+B - z otworem centralnym i otworami w kołnierzu

Charakterystyka:

- Oprawki przeznaczone do obrabiarek z automatyczną wymianą narzędzi
- Do mocowania oprawek w obrabiarce służą czopy
- Oprawki wykonane ze stali niklowo-chromowo-molibdenowej, nawęglane i hartowane na 58HRC
- Powierzchnia stożka precyzyjnie szlifowana w klasie AT3
- Gniazda narzędziowe wykonane z maksymalnym biciem 0,007mm
- W standardowym wykonaniu korpus wyważony w klasie G6,3/8000obr/min

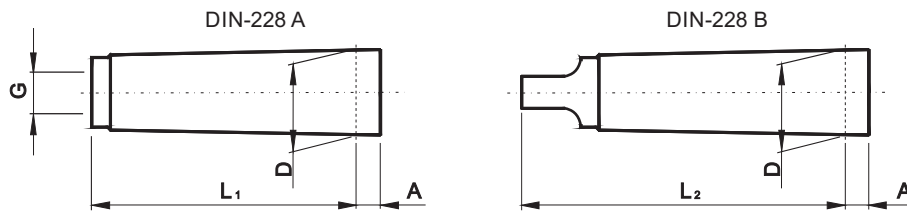
MORSE'A wg DIN-228

Stożek	D	A	L ₁	L ₂	G
MK1	12,065	3,5	53,5	62,0	M6
MK2	17,780	5,0	64,0	75,0	M10
MK3	23,825	5,0	81,0	94,0	M12
MK4	31,267	6,5	102,5	117,5	M16
MK5	44,399	6,5	129,5	149,5	M20

Charakterystyka:

- Oprawki wykonane ze stali niklowo-chromowo-molibdenowej, nawęglane i hartowane na 58HRC
- Powierzchnie przyłączeniowe precyzyjnie szlifowane w klasie AT3

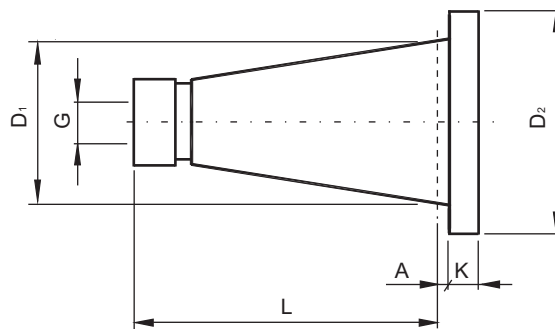
DIN wg DIN-2080

Stożek	D ₁	D ₂	L	A	K	G
DIN30	31,75	50,0	68,4	1,6	8	M12
DIN40	44,45	63,0	93,4	1,6	10	M16
DIN50	69,85	97,5	126,8	3,2	12	M24

Charakterystyka:

- Oprawki wykonane ze stali niklowo-chromowo-molibdenowej, nawęglane i hartowane na 58HRC
- Powierzchnia stożka precyzyjnie szlifowana w klasie AT3
- Gniazda narzędziowe wykonane z maksymalnym biciem 0,007mm

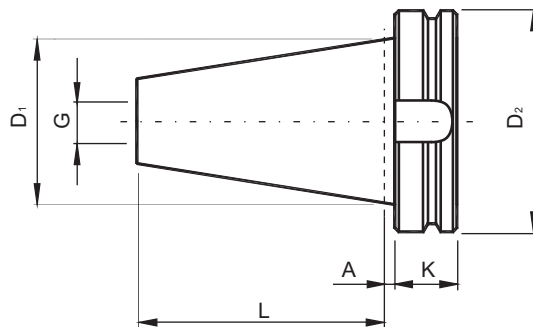
MAS BT wg JIS B6339

Stożek	D ₁	D ₂	L	A	K	G
BT30	31,75	46	48,4	2	22	M12
BT40	44,45	63	65,4	2	27	M16
BT50	69,85	100	101,8	3	38	M24

Wersje wykonania:

- chwyt bez wewnętrznego chłodzenia
- z otworem centralnym
- z otworem centralnym i otworami w kołnierzu

Charakterystyka:

- Oprapki przeznaczone do obrabiarek z automatyczną wymianą narzędzi
- Do mocowania oprapki w obrabiarce służą czopy
- Oprapki wykonane ze stali niklowo-chromowo-molibdenowej, nawęglane i hartowane na 58HRC
- Powierzchnia stożka precyzyjnie szlifowana w klasie AT3
- Gniazda narzędziowe wykonane z maksymalnym biciem 0,007mm
- W standardowym wykonaniu maksymalna prędkość obrotowa 10000obr/min

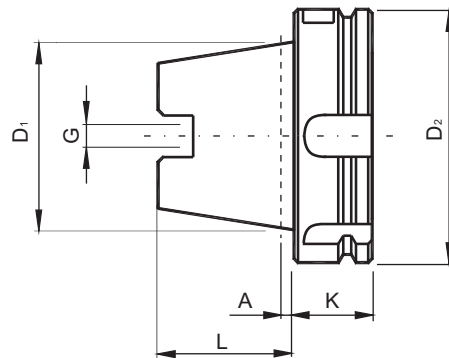
HSK wg DIN-69893 A

Stożek	D ₁	D ₂	L	A	K	G
HSK40	30	40	20	4,0	20	M12x1
HSK50	38	50	25	5,0	26	M16x1
HSK63	48	63	32	6,3	26	M18x1
HSK80	60	80	40	8,0	26	M20x1,5
HSK100	75	100	50	10,0	29	M24x1,5

Charakterystyka:

- Oprapki przeznaczone do obrabiarek z automatyczną wymianą narzędzi
- Oprapki wykonane ze stali niklowo-chromowo-molibdenowej, nawęglane i hartowane na 58HRC
- Powierzchnia stożka precyzyjnie szlifowana w klasie AT3
- Gniazda narzędziowe wykonane z maksymalnym biciem 0,007mm
- W standardowym wykonaniu korpus wyważony w klasie G6,3/8000obr/min
- Konstrukcja chwytu zapewnia dokładność pozycjonowania osiowego, wysoką sztywność, przenoszenie dużych momentów obrotowych przy wysokich prędkościach obrotowych

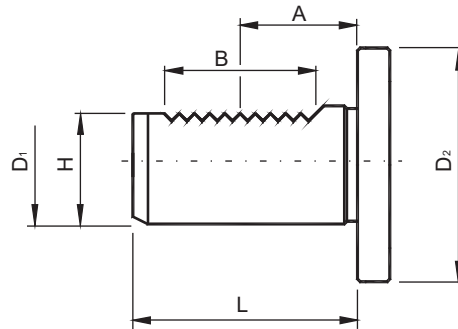
VDI wg DIN-69880

Chwył	D ₁	D ₂	H	L	A	B
VDI20	20	50	18	40	21,7	24
VDI25	25	58	23,5	48	21,7	24
VDI30	30	68	27	55	29,7	40
VDI40	40	83	36	63	29,7	40
VDI50	50	98	45	78	35,7	48

Charakterystyka:

- Oprapki wykonane ze stali chromowo-manganowej, nawęglane i hartowane na 58HRC
- Powierzchnia cylindryczna chwytu szlifowana w tolerancji h6

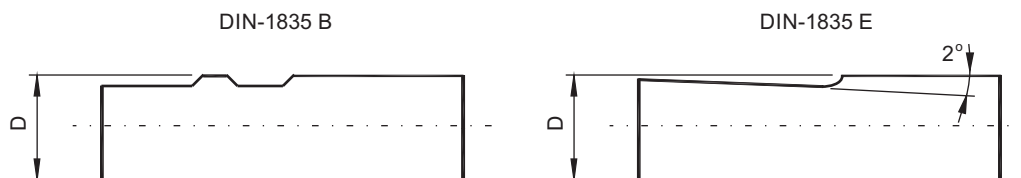
CYLINDRYCZNY wg DIN-1835

Chwył Weldon	D
W20	20
W25	25
W32	32
W40	40
W50	50

Wersje wykonania:

- DIN-1835 A - chwyt cylindryczny prosty
- DIN-1835 B - WELDON: chwyt cylindryczny ze spłaszczeniami równoległymi do osi walca
- DIN-1835 E - WHISTLE-NOTCH: chwyt cylindryczny ze spłaszczeniem 2°

Charakterystyka:

- Oprapki wykonane ze stali niklowo-chromowo-molibdenowej, nawęglane i hartowane na 58HRC
- Powierzchnia cylindryczna chwytu szlifowana w tolerancji h6

10. FREZY TRZPIENIOWE

10.1. Elementy konstrukcyjne frezów trzpieniowych

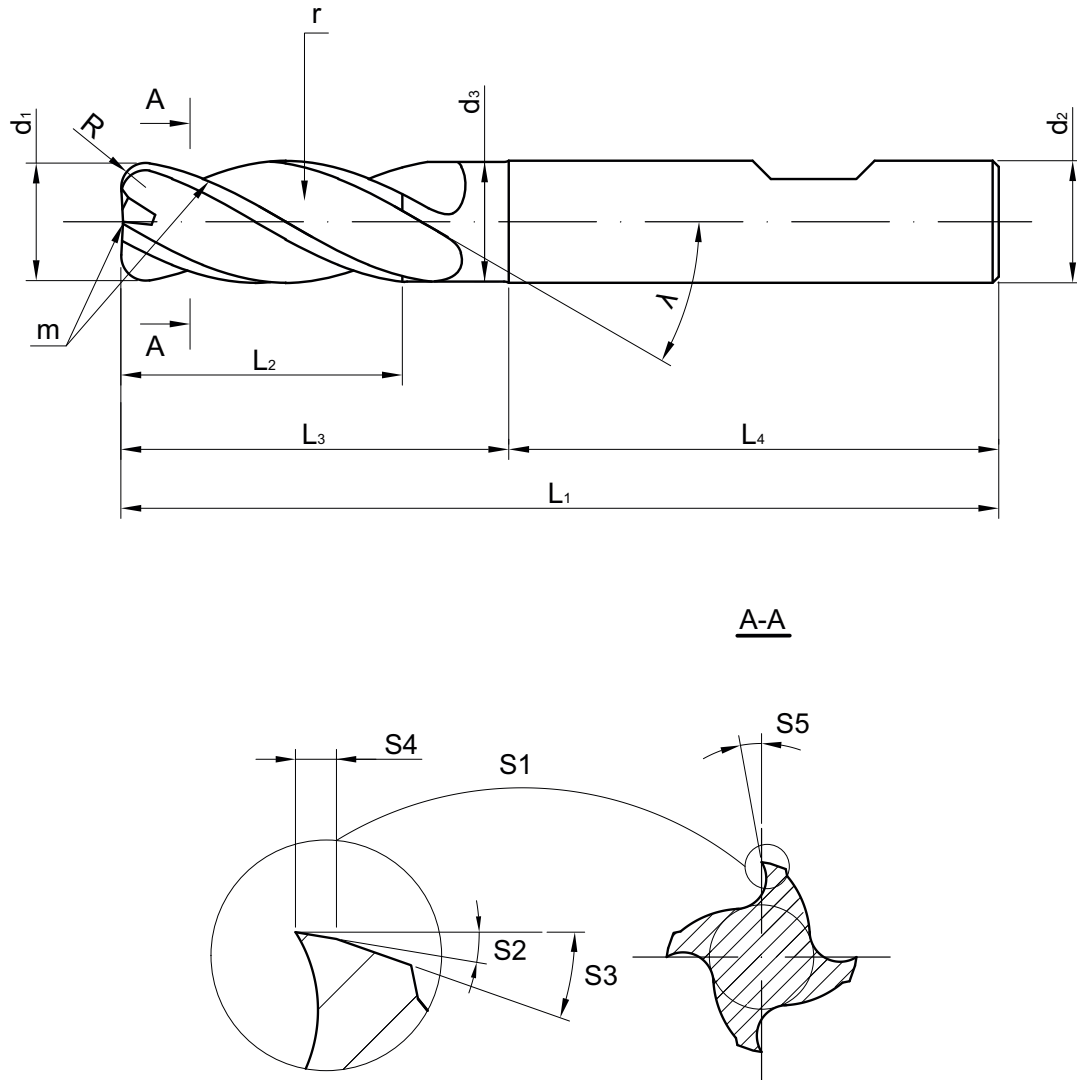

L1 - długość całkowita
 L2 - długość części roboczej
 L3 - długość użytkowa
 L4 - długość chwytu
 d1 - średnica części roboczej
 d2 - średnica chwytu
 d3 - średnica szyjki
 r - rowek wiórowy

λ - kąt pochylecia linii śrubowej
 R - promień naroża
 S1 - powierzchnia przyłożenia
 S2 - kąt przyłożenia pierwotny
 S3 - kąt przyłożenia wtórny
 S4 - szerokość pierwotnej powierzchni przyłożenia
 S5 - kąt natarcia
 m - krawędzie skrawające

10.2. Warianty naroży



Ostre naroże		
Czoło kuliste	Promień naroża	Faza naroża

10.3. Szyjka

Szyjki we frezach trzpieniowych stosowane są w celu zwiększenia długości użytkowej, co obrazuje poniższa tabela.

	Pierwsze przejście	Kolejne przejście
Frez z szyjką		
Frez bez szyjki		

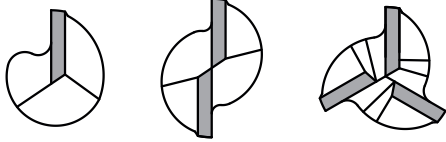
10.4. Ilość ostrzy

<p>Mniejsza ilość ostrzy</p>		<ul style="list-style-type: none"> • Większa pojemność rowków wiórowych • Możliwość pracy z większą szerokością roboczą a_e • Mniejsze ryzyko zapchania wiórami przy słabych warunkach
<p>Większa ilość ostrzy</p>		<ul style="list-style-type: none"> • Większy rdzeń • Większa sztywność narzędzia • Lepsza jakość powierzchni obrabianej • Wyższe wartości prędkości posuwów

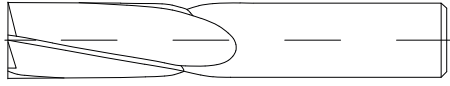
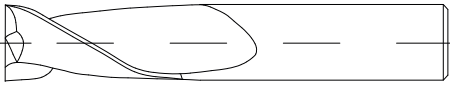
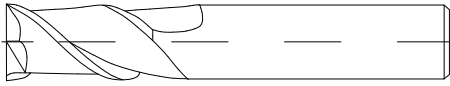
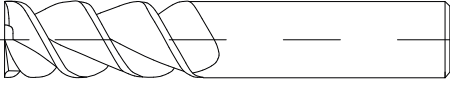

10.5. Spirala rowka wiórowego

<p>Mniejszy kąt spirali</p>	<p>10°</p>  <p>30°</p> 	<ul style="list-style-type: none"> • Mniejsze ryzyko wyciągnięcia z oprawki • Większa tendencja do powstawania wibracji
<p>Większy kąt spirali</p>	<p>45°</p>  <p>60°</p> 	<ul style="list-style-type: none"> • Więcej ostrzy w przyporze • Dłuższe krawędzie skrawające • Łagodniejsza praca i mniejsze wibracje • Lepsza jakość powierzchni obrabianej

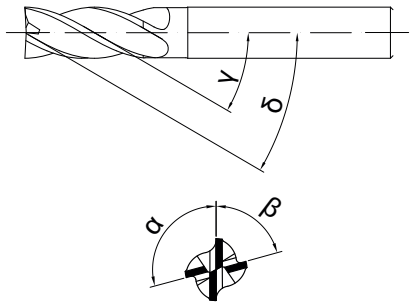
10.6. Zmienna geometria

<p>Zmienna podziałka i kąt spirali</p>		<ul style="list-style-type: none"> • Kolejne ostrza wchodzą w materiał w nierównomiernych odstępach czasu, co znacząco redukuje występowanie drgań • Zwiększa trwałość narzędzia Umożliwia pracę z większymi prędkościami skrawania
--	---	---

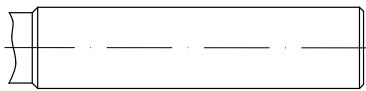
10.7. Rodzaj chwytu

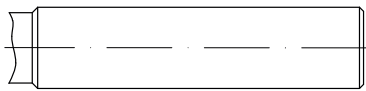
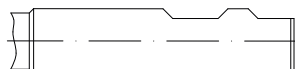
Średnice	Chwyt walcowy - Forma HA	Chwyt walcowy - Forma HB „Weldon”
<p>Ø6 - Ø20</p>		
<p>Ø25 - Ø32</p>		

10.8. Oznaczenia i zastosowania

10.8.a. Grupy narzędzi według zastosowania

<p>MASTERMILL</p> <p>P M K N S</p>	<p>Wysokowydajne frezy do pracy na centrach obróbczych, przeznaczone do obróbki stali konstrukcyjnych i nierdzewnych o twardości do 45 HRC, żeliw oraz materiałów trudnoobrabialnych na bazie tytanu i niklu.</p>
<p>X-MILL</p> <p>P M K</p>	<p>Frezy ogólnego przeznaczenia do obróbki materiałów o twardości do 35 HRC.</p>
<p>AL</p> <p>N</p>	<p>Grupa frezów przeznaczona do wysokowydajnej obróbki metali nieżelaznych takich jak stopy aluminium lub miedzi. Charakteryzują się zoptymalizowaną geometrią, polerowanymi rowkami wiórowymi oraz możliwym wariantem wykonania z powłoką TB.</p>
<p>HRC</p> <p>H</p>	<p>Frezy wykonane z gatunku węgliku o nanometrycznej wilkości ziaren (< 0,2µm), przeznaczonego do obróbki materiałów zahartowanych. Posiadają powłokę TS oraz geometrię umożliwiającą obróbkę materiałów o twardości ponad 65 HRC.</p>

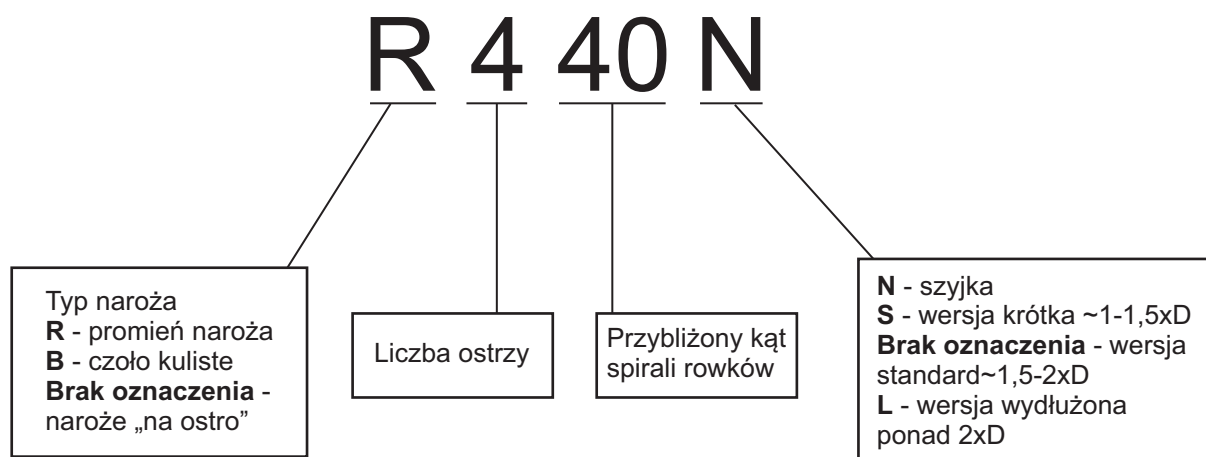

10.8.b. Oznaczenie

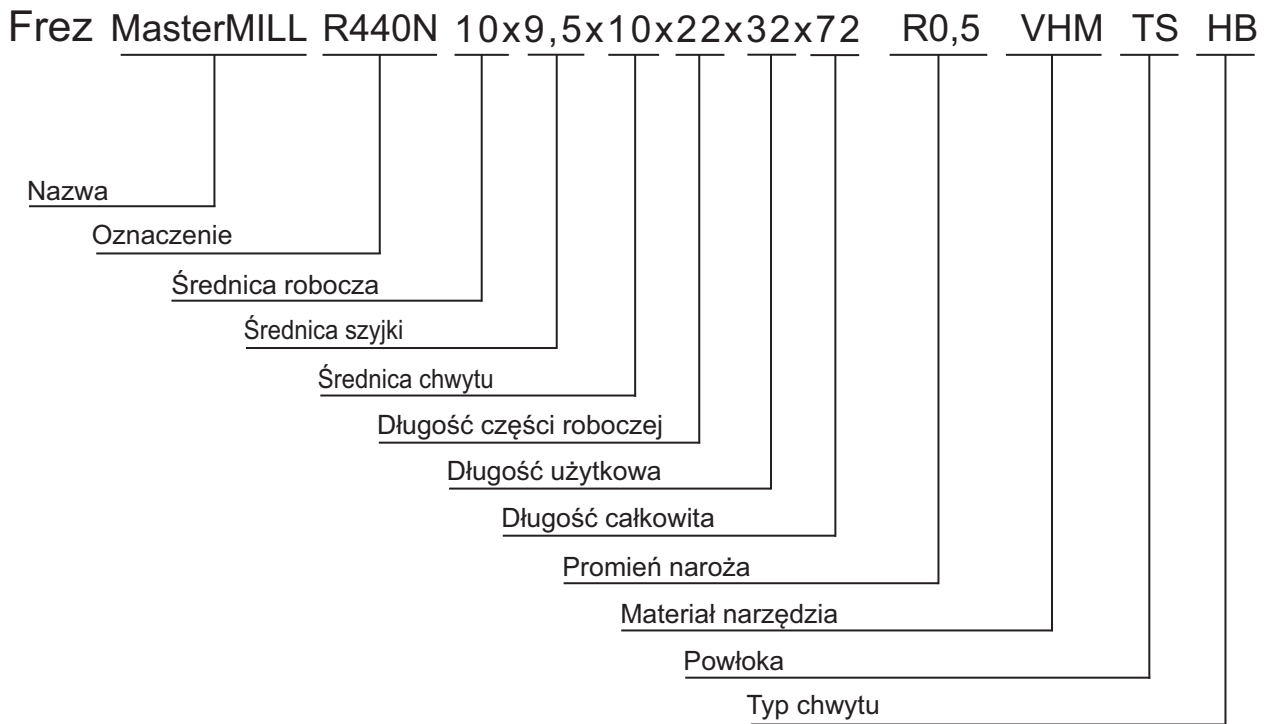

10.8.c. Cechowanie

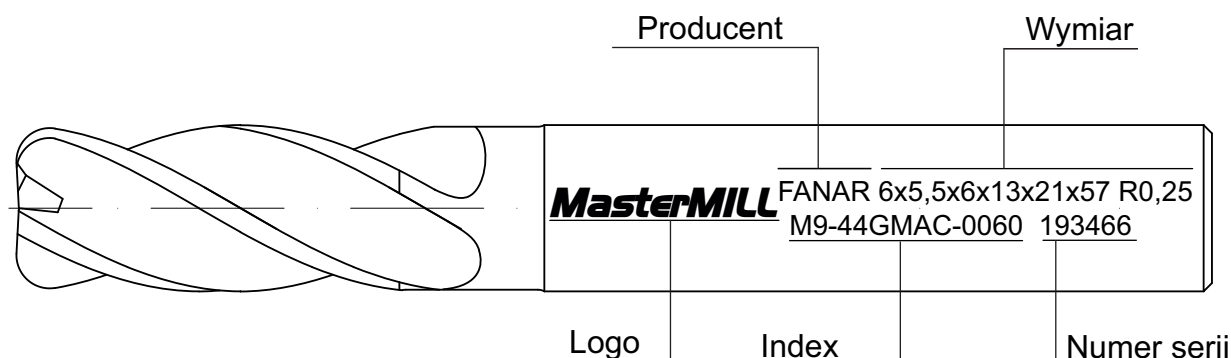

10.9. Zalecenia technologiczne przy frezowaniu

10.9.a. Skuteczne i wydajne frezowanie jest wynikiem:

- Stanu technicznego maszyny (musi zapewniać niezbędną moc wrzeciona dla dobranych parametrów oraz minimalne bicie promieniowe i wystarczającą sztywność)
- Właściwego doboru freza
- Doboru precyzyjnej i sztywnej oprawki
- Sztywnego i bezpiecznego zamocowania przedmiotu obrabianego
- Doboru chłodziwa
- Zastosowanej strategii obróbki

10.9.b. Dobór narzędzia

Frez należy dobrać według „Tabeli doboru” zgodnie z obrabianym materiałem. Dla zapewnienia wysokiej sztywności, narzędzie powinno mieć możliwie krótki wysięg oraz dużą średnicę. Do operacji rowkowania przeznaczone są frezy o mniejszej liczbie ostrzy (1-4), zapewniającej dużo miejsca w rowkach wiórowych. Przy profilowaniu, w celu uzyskania lepszej powierzchni stosowane są frezy o liczbie ostrzy 4 i więcej.

10.9.c. Mocowanie narzędzia

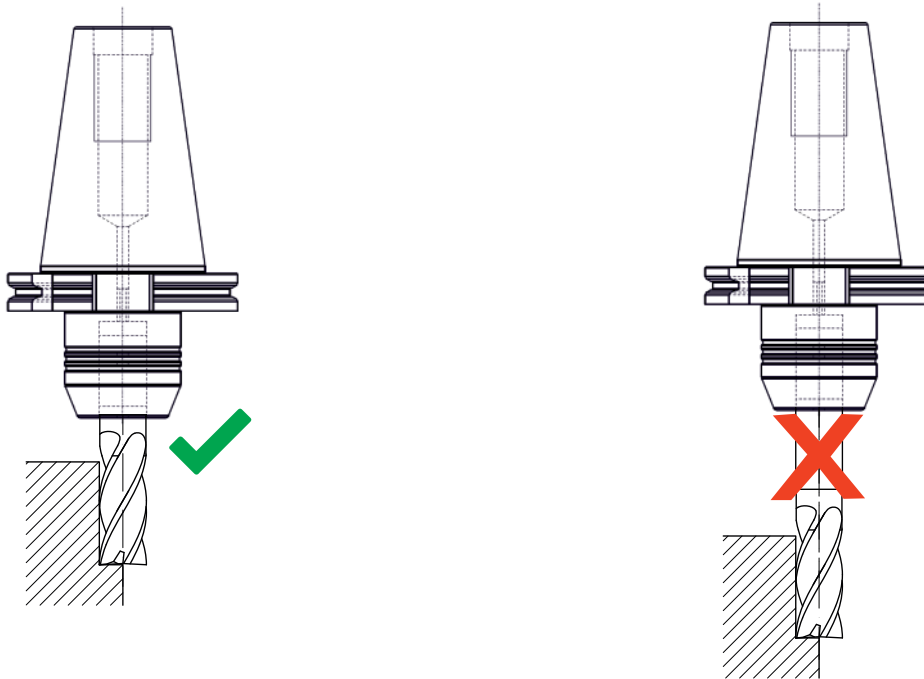

Przy frezowaniu wysokowydajnym stosuj oprawki z zamocowaniem hydraulicznym lub skurczowym o małym wysięgu, gwarantujące sztywność i precyzję zamocowania. Zawsze zapewnij minimalne wysunięcie narzędzia z oprawki.

10.9.d. Chłodziwo

Frezowanie na sucho zwiększa żywotność narzędzia!

Frezowanie w przeciwieństwie np. do wiercenia nie jest ciągłym procesem. Ostrza cyklicznie wchodzą i wychodzą z obrabianego materiału. Powoduje to narażenie węglkowych ostrzy na duże wahania temperatur, które może być spotęgowane przez stosowanie cieczy chłodzących.

Poddawanie szokom termicznym krawędzi skrawających może prowadzić do powstania pęknięć i wczesnego zużycia narzędzia. Należy zatem unikać stosowania chłodziwa w sytuacjach, gdzie w strefie skrawania wydziela się dużo ciepła.

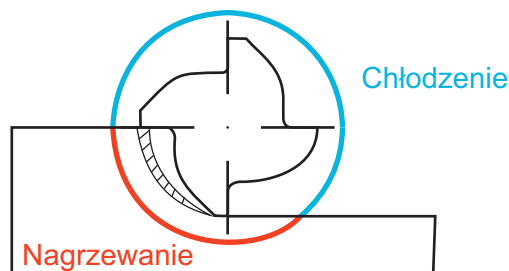

Najlepszym rozwiązaniem ułatwiania usuwania wiórów oraz zapobiegnięcia ich zakleszczeniu jest stosowanie systemów sprężonego powietrza.

Uzasadnione sytuacje stosowania chłodziwa podczas pracy frezami węglkowymi to:

- obróbka wykańczająca stali nierdzewnej i aluminium
- obróbka stopów żaroodpornych
- obróbka przedmiotów cienkościennych

10.9.e. Technologia i strategia obróbki

W celu zwiększenia żywotności freza, zaleca się frezowanie współbieżne. Wyjątek może stanowić obróbka materiału powierzchniowo utwardzonego (np. po operacji termicznego cięcia palnikiem gazowym).

Frezowanie współbieżne

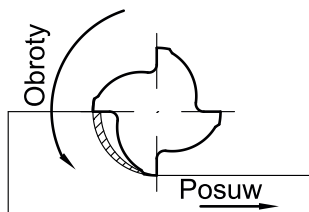

Frezowanie przeciwbieżne

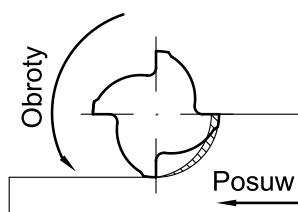

Frezowanie wgłębień najczęściej rozpoczyna się od wiercenia otworu wstępnego. Stosuje się również interpolację spiralną i skośną. W tych przypadkach należy obniżyć posuw do 25-50% wartości z tablic, a prędkości skrawania przyjąć jak dla rowkowania.

W każdym przypadku obróbki, warunki pracy freza mogą się znacznie różnić. W związku z tym na początku obróbki zaleca się obniżenie parametrów skrawania do 50% podanych w tablicach doboru, a następnie ich zwiększenie.

Odstępstwa od opisanych warunków, przekroczenie głębokości osiowej a_p i szerokości a_e , może skutkować koniecznością obniżenia parametrów skrawania V_c i f_z w stosunku do podanych w tablicach.

10.9.f. Szybkościowe strategie frezowania

Szybkościowe strategie frezowania HSM (*High Speed Machining*) – oparte są na kontroli i dążeniu do zminimalizowania grubości wiórów. Odpowiednio modyfikując parametry obróbkowe, a w niektórych przypadkach używając narzędzi o specjalnej konstrukcji, możliwe jest osiągnięcie mniejszego obciążenia mechanicznego i termicznego krawędzi skrawających przy wzroście produktywności. Szybkościowe strategie frezowania zostały opracowane z myślą o obróbce kanałków i kieszeni w materiałach zahartowanych oraz trudnoobrabialnych, jednak mogą być z powodzeniem stosowane również w pozostałych stalach, czy np. stopach aluminium.

Wpływ szerokości frezowania a_e oraz kąta opasania narzędzia na grubość wiórów przy zachowaniu identycznego posuwu na ostrze.

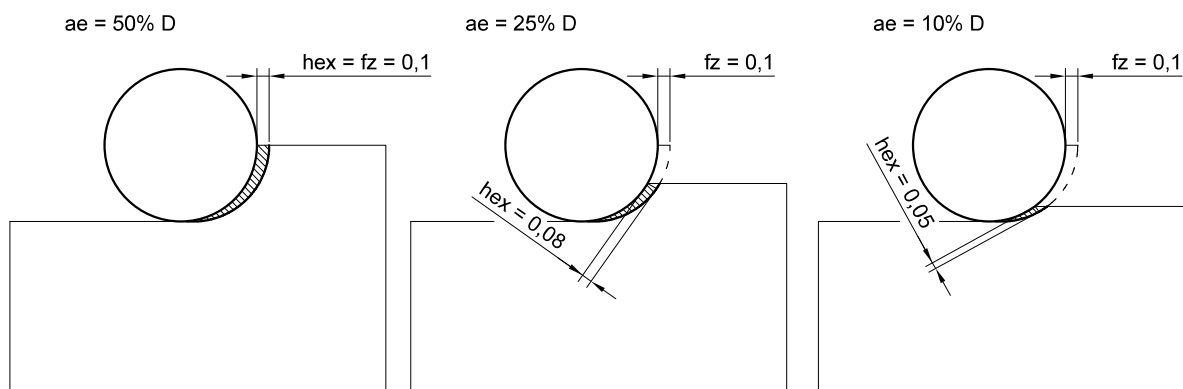

Zmniejszenie grubości wiórów redukuje działające na ostrza siły skrawania. Pozwala to na zwiększenie parametrów obróbki, co wpływa na większą produktywność. W połączeniu z odpowiednią strategią obróbki (ścieżką narzędzia) wydłużona zostaje żywotność narzędzia.

Najczęściej spotykanymi strategiami bazującymi na minimalizowaniu grubości wiórów jest:

- Frezowanie trochoidalne
- Strategia frezowania z wysokimi posuwami HFM (*High Feed Milling*)

Frezowanie trochoidalne

Frezowanie trochoidalne - polega na zaprogramowaniu ścieżki freza po krzywej zwanej trochoidą, można to określić jako frezowanie kołowe z jednoczesnym ruchem narzędzia do przodu. Jest to metoda, która znajduje zastosowanie głównie do frezowania rowków oraz kieszeni.

Do cech tej metody należą:

- **Wykorzystanie całej długości roboczej narzędzi (wysokie ap)** - równomierne zużycie krawędzi skrawających
- **Bardzo mała szerokość frezowania ae i mały kąt opasania narzędzia** - redukcja grubości hex wióra i sił promieniowych
- **Możliwie najwyższa prędkość skrawania V_c i liczba ostrzy** - wysokie prędkości posuwu i produktywność

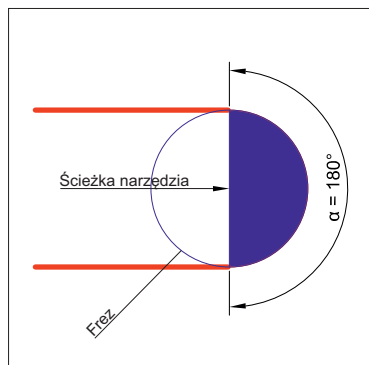

Frezowanie konwencjonalne w pełnym materiale

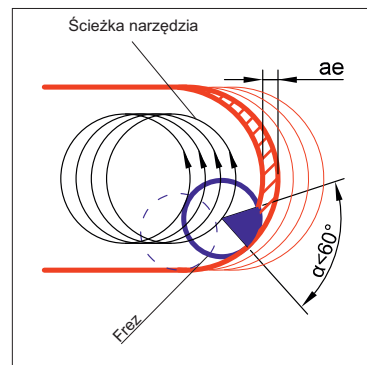

Frezowanie trochoidalne

Frezowanie z wysokimi posuwami HFM

Frezowanie z wysokimi posuwami HFM – strategia frezowania polegająca na zastosowaniu narzędzia o specjalnej geometrii czoła, pozwalającej na obróbkę z kilkukrotnie wyższymi wartościami posuwu na ostrze w porównaniu do konwencjonalnej obróbki, a zarazem zmniejszenie grubości wiórów.

Do cech tej metody należą:

- **Bardzo mała głębokość robocza ap** – redukcja grubości wióra hex i sił promieniowych;
- **Duża szerokość frezowania ae i posuwu na ostrze fz** – równomierne zużycie specjalnie ukształtowanej krawędzi skrawającej;
- **Możliwie najwyższy posuw na ostrze fz i liczba ostrzy** – wysokie prędkości posuwu i produktywność.

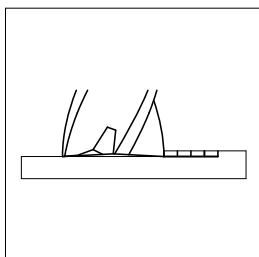

Konwencjonalny frez

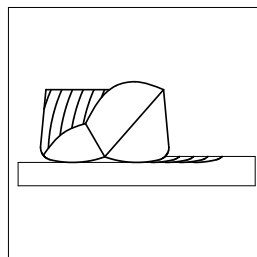

Frez do obróbki HFM

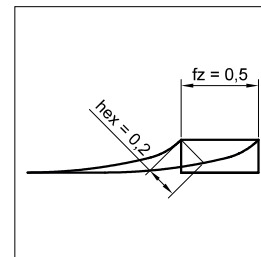

Porównanie kształtu wiórów przy takim samym fz

Wymagania przy stosowaniu szybkościowych strategii frezowania:

- Obrabiarka dysponująca odpowiednio wysoką szybkością obrotową wrzeciona
- Duża dynamika obrabiarki – częste zmiany kierunku i wartości posuwu
- W niektórych przypadkach dużych średnic narzędzi wyważenie narzędzia z oprawką
- Konieczność posiadania możliwości zaprogramowania ścieżki narzędzia – oprogramowanie CAM
- Odpowiednia konstrukcja narzędzia

10.10. Wzory i tabele

10.10.a. Wzory obliczeniowe parametrów skrawania.

Symbol	Jednostka	Nazwa	Wzór
V_c	m/min	Prędkość skrawania	$v_c = \frac{d_1 \times \pi \times n}{1000}$
n	1/min	Prędkość obrotowa wrzeciona	$n = \frac{1000 \times v_c}{d_1 \times \pi}$
V_f	mm/min	Prędkość posuwu	$v_f = f_z \times n \times z$
f_z	mm	Posuw na ostrze	$f_z = \frac{v_f}{n \times z}$

d_1 [mm] - rzeczywista średnica robocza

z - ilość ostrzy

10.10.b. Współczynniki prędkości skrawania dla frezów trzpieniowych VHM w zależności od szerokości pracy a_e

a_e / D	1-0,5	0,4	0,3	0,2	0,1	0,05	0,04
Mnożnik prędk. skrawania V_c	1	1,1	1,2	1,3	1,4	2,5	3

10.10.c. Rzeczywista średnica robocza frezów kulistych w zależności od głębokości skrawania

$\varnothing d_1$	Głębokość skrawania a_p [mm]																
	0,01	0,02	0,03	0,04	0,05	0,08	0,1	0,15	0,2	0,3	0,5	0,8	1,0	2,0	3,0	4,0	5,0
1	0,199	0,280	0,341	0,392	0,436	0,543	0,600	0,714	0,800	0,917	1,000	-	-	-	-	-	-
2	0,282	0,398	0,486	0,560	0,624	0,784	0,872	1,054	1,200	1,428	1,732	1,960	2,000	-	-	-	-
3	0,346	0,488	0,597	0,688	0,768	0,967	1,077	1,308	1,497	1,800	2,236	2,653	2,828	2,828	-	-	-
4	0,399	0,564	0,690	0,796	0,889	1,120	1,249	1,520	1,744	2,107	2,646	3,200	3,464	4,000	-	-	-
5	0,447	0,631	0,772	0,891	0,995	1,255	1,400	1,706	1,960	2,375	3,000	3,666	4,000	4,899	4,899	-	-
6	0,489	0,692	0,846	0,977	1,091	1,376	1,536	1,873	2,154	2,615	3,317	4,079	4,472	5,657	6,000	-	-
8	0,565	0,799	0,978	1,129	1,261	1,592	1,778	2,170	2,498	3,040	3,873	4,800	5,292	6,928	7,746	8,000	-
10	0,632	0,894	1,094	1,262	1,411	1,782	1,990	2,431	2,800	3,412	4,359	5,426	6,000	8,000	9,165	9,798	10,000
12	0,693	0,979	1,198	1,383	1,546	1,953	2,182	2,666	3,072	3,747	4,796	5,987	6,633	8,944	10,392	11,314	11,832
14	0,748	1,058	1,295	1,495	1,670	2,111	2,358	2,883	3,323	4,055	5,196	6,499	7,211	9,798	11,489	12,649	13,416
16	0,800	1,131	1,384	1,598	1,786	2,257	2,522	3,084	3,555	4,341	5,568	6,974	7,746	10,583	12,490	13,856	14,832
18	0,848	1,199	1,468	1,695	1,895	2,395	2,676	3,273	3,774	4,609	5,916	7,419	8,246	11,314	13,416	14,967	16,125
20	0,894	1,264	1,548	1,787	1,997	2,525	2,821	3,451	3,980	4,862	6,245	7,838	8,718	12,000	14,283	16,000	17,321

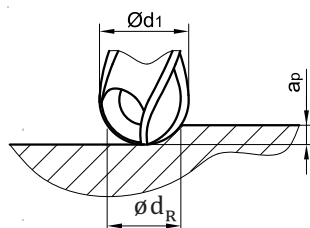

$$\varnothing d_R = 2 \cdot \sqrt{a_p (\varnothing d_1 - a_p)}$$

11. TABELE INFORMACYJNE

11.1. Zalecane średnice otworów pod gwintowniki

Gwint metryczny ISO

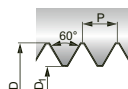

M Gwint metryczny zwykły ISO DIN-13

MF Gwint metryczny drobnoszwyjny ISO DIN-13

Wymiar nominalny		D ₁ (6H)			Wymiar nominalny		D ₁ (6H)			Nom. size		D ₁ (6H)		
D mm	P mm	min. mm	max. mm		D mm	x P mm	min. mm	max. mm		D mm	x P mm	min. mm	max. mm	
M 1	0,25	0,729	0,785	0,75	M 2,5 x 0,35	2,121	2,221	2,15	M 35 x 1,5	33,376	33,676	33,5		
1,1	0,25	0,829	0,885	0,85	2,6 x 0,35	2,221	2,321	2,25	36 x 1,5	34,376	34,676	34,5		
1,2	0,25	0,929	0,985	0,95	3 x 0,35	2,621	2,721	2,65	36 x 2	33,835	34,210	34		
1,4	0,3	1,075	1,142	1,1	3,5 x 0,35	3,121	3,221	3,15	36 x 3	32,752	33,252	33		
1,6	0,35	1,221	1,321	1,25	4 x 0,35	3,621	3,721	3,65	38 x 1,5	36,376	36,676	36,5		
1,7	0,35	1,321	1,421	1,35	4 x 0,5	3,459	3,599	3,5	39 x 1,5	37,376	37,676	37,5		
1,8	0,35	1,421	1,521	1,45	5 x 0,5	4,459	4,599	4,5	39 x 2	36,835	37,210	37		
2	0,4	1,567	1,679	1,6	6 x 0,5	5,459	5,599	5,5	39 x 3	35,752	36,252	36		
2,2	0,45	1,713	1,838	1,75	6 x 0,75	5,188	5,378	5,2	40 x 1,5	38,376	38,676	38,5		
2,3	0,4	1,867	1,979	1,9	7 x 0,75	6,188	6,378	6,2	40 x 2	37,835	38,210	38		
2,5	0,45	2,013	2,138	2,05	8 x 0,75	7,188	7,378	7,2	42 x 1,5	40,376	40,676	40,5		
2,6	0,45	2,113	2,238	2,15	8 x 1	6,917	7,153	7	42 x 2	39,835	40,210	40		
3	0,5	2,459	2,599	2,5	9 x 0,75	8,188	8,378	8,2	42 x 3	38,752	39,252	39		
3,5	0,6	2,850	3,010	2,9	9 x 1	7,917	8,153	8	45 x 1,5	43,376	43,676	43,5		
4	0,7	3,242	3,422	3,3	10 x 0,75	9,188	9,378	9,2	45 x 2	42,835	43,210	43		
4,5	0,75	3,688	3,878	3,7	10 x 1	8,917	9,153	9	45 x 3	41,752	42,252	42		
5	0,8	4,134	4,334	4,2	10 x 1,25	8,647	8,912	8,8	48 x 1,5	46,376	46,676	46,5		
5,5	0,9	4,526	4,750	4,6	11 x 1	9,917	10,153	10	48 x 2	45,835	46,210	46		
6	1	4,917	5,153	5	12 x 1	10,917	11,153	11	48 x 3	44,752	45,252	45		
7	1	5,917	6,153	6	12 x 1,25	10,647	10,912	10,8	50 x 1,5	48,376	48,676	48,5		
8	1,25	6,647	6,912	6,8	12 x 1,5	10,376	10,676	10,5	50 x 2	47,835	48,210	48		
9	1,25	7,647	7,912	7,8	14 x 1	12,917	13,153	13	52 x 1,5	50,376	50,676	50,5		
10	1,5	8,376	8,676	8,5	14 x 1,25	12,647	12,912	12,8	52 x 2	49,835	50,210	50		
11	1,5	9,376	9,676	9,5	14 x 1,5	12,376	12,676	12,5	52 x 3	48,752	49,252	49		
12	1,75	10,106	10,441	10,2	15 x 1	13,917	14,153	14	56 x 3	52,752	53,252	53		
14	2	11,835	12,210	12	16 x 1	14,917	15,153	15	56 x 4	51,670	52,270	52		
16	2	13,835	14,210	14	16 x 1,5	14,376	14,676	14,5	60 x 4	55,670	56,270	56		
18	2,5	15,294	15,744	15,5	18 x 1	16,917	17,153	17	64 x 3	60,752	61,252	61		
20	2,5	17,294	17,744	17,5	18 x 1,5	16,376	16,676	16,5	64 x 4	59,670	60,270	60		
22	2,5	19,294	19,744	19,5	18 x 2	15,835	16,210	16	68 x 4	63,670	64,270	64		
24	3	20,752	21,252	21	20 x 1	18,917	19,153	19	70 x 3	66,752	67,252	67		
27	3	23,752	24,252	24	20 x 1,5	18,376	18,676	18,5	70 x 4	65,670	66,270	66		
30	3,5	26,211	26,771	26,5	20 x 2	17,835	18,210	18	72 x 3	68,752	69,252	69		
33	3,5	29,211	29,771	29,5	22 x 1	20,917	21,153	21	72 x 4	67,670	68,270	68		
36	4	31,670	32,270	32	22 x 1,5	20,376	20,676	20,5	72 x 6	65,505	66,305	66		
39	4	34,670	35,270	35	22 x 2	19,835	20,210	20	76 x 3	72,752	73,252	73		
42	4,5	37,129	37,799	37,5	24 x 1	22,917	23,153	23	76 x 4	71,670	72,270	72		
45	4,5	40,129	40,799	40,5	24 x 1,5	22,376	22,676	22,5	76 x 6	69,505	70,305	70		
48	5	42,587	43,297	43	24 x 2	21,835	22,210	22	80 x 4	75,670	76,270	76		
52	5	46,587	47,297	47	25 x 1,5	23,376	23,676	23,5	80 x 6	73,505	74,305	74		
56	5,5	50,046	50,796	50,5	26 x 1,5	24,376	24,676	24,5	85 x 3	81,752	82,252	82		
60	5,5	54,046	54,796	54,5	27 x 1,5	25,376	25,676	25,5	85 x 4	80,670	81,270	81		
64	6	57,505	58,305	58	27 x 2	24,835	25,210	25	90 x 3	86,752	87,252	87		
68	6	61,505	62,305	62	28 x 1,5	26,376	26,676	26,5	90 x 4	85,670	86,270	86		
					28 x 2	25,835	26,210	26	90 x 6	83,505	84,305	84		
					30 x 1,5	28,376	28,676	28,5	95 x 6	88,505	89,305	89		
					30 x 2	27,835	28,210	28	100 x 4	95,670	96,270	96		
					32 x 1,5	30,376	30,676	30,5	100 x 6	93,505	94,305	94		
					32 x 2	29,835	30,210	30	110 x 6	103,505	104,305	104		
					33 x 1,5	31,376	31,676	31,5	115 x 3	111,752	112,252	112		
					33 x 2	30,835	31,210	31	120 x 4	115,670	116,270	116		
					34 x 1,5	32,376	32,676	32,5	120 x 6	113,505	114,305	114		

11.2. Zalecane średnice otworów pod gwintowniki

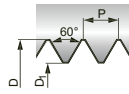
Gwint zunifikowany



UNC Gwint amerykański zunifikowany ANSI B-1.1

Wymiar nominalny		D ₁ (2B)		 mm
D cal	Gg/1" (tpi)	min. mm	max. mm	
Nr. 1	- 64	1,425	1,582	1,55
Nr. 2	- 56	1,694	1,872	1,85
Nr. 3	- 48	1,941	2,146	2,1
Nr. 4	- 40	2,156	2,385	2,35
Nr. 5	- 40	2,487	2,697	2,65
Nr. 6	- 32	2,647	2,896	2,85
Nr. 8	- 32	3,307	3,528	3,5
Nr. 10	- 24	3,680	3,949	3,9
Nr. 12	- 24	4,341	4,590	4,5
1/4	- 20	4,976	5,268	5,1
5/16	- 18	6,411	6,734	6,6
3/8	- 16	7,805	8,164	8
7/16	- 14	9,149	9,550	9,4
1/2	- 13	10,584	11,016	10,8
9/16	- 12	11,996	12,456	12,2
5/8	- 11	13,376	13,868	13,5
3/4	- 10	16,299	16,833	16,5
7/8	- 9	19,169	19,748	19,5
1"	- 8	21,963	22,598	22,25
1 1/8	- 7	24,648	25,349	25
1 1/4	- 7	27,823	28,524	28
1 3/8	- 6	30,343	31,120	30,75
1 1/2	- 6	33,518	34,295	34
1 3/4	- 5	38,951	39,814	39,5
2"	- 4 1/2	44,689	45,598	45

UNF Gwint amerykański zunifikowany drobnozwojny ANSI B-1.1

Wymiar nominalny		D ₁ (2B)		 mm
D cal	Gg/1" (tpi)	min. mm	max. mm	
Nr. 2	- 64	1,755	1,913	1,85
Nr. 3	- 56	2,024	2,197	2,15
Nr. 4	- 48	2,271	2,459	2,4
Nr. 5	- 44	2,550	2,741	2,7
Nr. 6	- 40	2,817	3,012	2,95
Nr. 8	- 36	3,401	3,597	3,5
Nr. 10	- 32	3,967	4,168	4,1
Nr. 12	- 28	4,503	4,716	4,6
1/4	- 28	5,367	5,580	5,5
5/16	- 24	6,792	7,038	6,9
3/8	- 24	8,379	8,626	8,5
7/16	- 20	9,738	10,030	9,9
1/2	- 20	11,326	11,618	11,5
9/16	- 18	12,761	13,084	12,9
5/8	- 18	14,348	14,671	14,5
3/4	- 16	17,330	17,689	17,5
7/8	- 14	20,262	20,663	20,4
1"	- 12	23,109	23,569	23,25
1 1/8	- 12	26,284	26,744	26,5
1 1/4	- 12	29,459	29,919	29,5
1 3/8	- 12	32,634	33,094	32,75
1 1/2	- 12	35,809	36,269	36

UN-8

Wymiar nominalny		D ₁ (2B)		 mm
D cal	Gg/1" (tpi)	min. mm	max. mm	
1 1/8	- 8	25,138	25,773	25,4
1 1/4	- 8	28,313	28,948	28,6
1 1/2	- 8	34,663	35,298	35
1 3/4	- 8	41,013	41,648	41,3
2"	- 8	47,363	47,998	47,7

UNEF

Wymiar nominalny		D ₁ (2B)		 mm
D cal	Gg/1" (tpi)	min. mm	max. mm	
1/4	- 32	5,491	5,679	5,55
5/16	- 32	7,079	7,267	7,15
3/8	- 32	8,666	8,854	8,7
7/16	- 28	10,130	10,343	10,2
1/2	- 28	11,717	11,930	11,8
9/16	- 24	13,142	13,388	13,2
5/8	- 24	14,729	14,975	14,8
3/4	- 20	17,676	17,968	17,8
7/8	- 20	20,851	21,143	20,95
1"	- 20	24,026	24,318	24,15

Cylindryczne gwinty rurowe

G

Gwint rurowy walcowy Whitwortha DIN-ISO 228

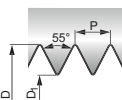

Wymiar nominalny D - P/1" cal (tpi)	D ₁		 mm
	min. mm	max. mm	
G 1/16 - 28	6,561	6,843	6,8
1/8 - 28	8,566	8,848	8,8
1/4 - 19	11,445	11,890	11,8
3/8 - 19	14,950	15,395	15,25
1/2 - 14	18,631	19,172	19
5/8 - 14	20,587	21,128	21
3/4 - 14	24,117	24,658	24,5
7/8 - 14	27,877	28,418	28,25
1" - 11	30,291	30,931	30,75
1 1/8 - 11	34,939	35,579	35,5
1 1/4 - 11	38,952	39,592	39,5
1 3/8 - 11	41,365	42,005	41,75
1 1/2 - 11	44,845	45,485	45,25
1 5/8 - 11	49,030	49,670	49,5
1 3/4 - 11	50,788	51,428	51
2" - 11	56,656	57,296	57
2 1/4 - 11	62,752	63,392	63,3
2 1/2 - 11	72,226	72,866	72,8
2 3/4 - 11	78,576	79,216	79,1
3" - 11	84,926	85,566	85,5

NPSM

Gwint amerykański rurowy walcowy ANSI/ASME B1.20.1

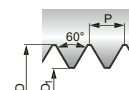

Wymiar nominalny D - P/1" cal (tpi)	D ₁		 mm
	min. mm	max. mm	
1/8 - 27	9,093	9,246	9,1
1/4 - 18	11,887	12,217	12
3/8 - 18	15,316	15,545	15,5
1/2 - 14	18,974	19,279	19
3/4 - 14	24,333	24,638	24,5
1" - 11 1/2	30,505	30,759	30,5

NPSF

Gwint amerykański rurowy walcowy ANSI B1.20.3

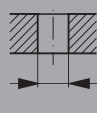
Wymiar nominalny D - P/1" cal (tpi)	D ₁		 mm
	min. mm	max. mm	
1/16 - 27	6,304	6,393	6,35
1/8 - 27	8,651	8,740	8,7
1/4 - 18	11,232	11,364	11,3
3/8 - 18	14,671	14,803	14,75
1/2 - 14	18,118	18,288	18,2
3/4 - 14	23,465	23,635	23,5
1" - 11 1/2	29,464	29,670	29,5

Rp(BSPP)

Gwint rurowy walcowy Whitwortha wewnętrzny PN-ISO 7/1 i DIN EN 10226-1 (identyczny z BSPP)

Wymiar nominalny D - P/1" cal (tpi)	D ₁		 mm
	min. mm	max. mm	
Rp1/16 - 28	6,490	6,632	6,55
1/8 - 28	8,495	8,637	8,6
1/4 - 19	11,341	11,549	11,5
3/8 - 19	14,846	15,054	15
1/2 - 14	18,489	18,773	18,5
3/4 - 14	23,975	24,259	24
1" - 11	30,111	30,471	30,25

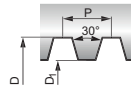

Gwint trapezowy i okrągły

Tr Gwint Trapezowy symetryczny
DIN-103

Wymiar nominalny			D ₁ (7H)		 mm
D mm	x P mm	min. mm	max. mm	mm	
Tr 8	x 1,5	6,5	6,69	6,6	
	9 x 2	7	7,236	7,2	
	10 x 2	8	8,236	8,2	
	10 x 3	7	7,315	7,25	
	11 x 3	8	8,315	8,25	
	12 x 3	9	9,315	9,25	
	14 x 3	11	11,315	11,25	
	14 x 4	10	10,375	10,25	
	16 x 4	12	12,375	12,25	
	18 x 4	14	14,375	14,25	
	20 x 4	16	16,375	16,25	
	22 x 5	17	17,45	17,25	
	24 x 5	19	19,45	19,25	
	26 x 5	21	21,45	21,25	
	28 x 5	23	23,45	23,25	
	30 x 6	24	24,5	24,25	
	32 x 6	26	26,5	26,25	
	34 x 6	28	28,5	28,25	
	36 x 6	30	30,5	30,25	
	38 x 7	31	31,56	31,5	
	40 x 7	33	33,56	33,5	
	42 x 7	35	35,56	35,5	
	44 x 7	37	37,56	37,5	
	46 x 8	38	38,63	38,5	
	48 x 8	40	40,63	40,5	
	50 x 8	42	42,63	42,5	
	52 x 8	44	44,63	44,5	

BSF

Wymiar nominalny		D ₁		 mm
D - P/1" (tpi)	min. mm	max. mm	mm	
BSF 3/16 - 32	3,747	4,006	4	
1/4 - 26	5,100	5,398	5,3	
5/16 - 22	6,459	6,817	6,8	
3/8 - 20	7,899	8,331	8,3	
7/16 - 18	9,304	9,764	9,7	
1/2 - 16	10,668	11,163	11,1	
5/8 - 14	13,553	14,094	14	
3/4 - 12	16,337	16,939	16,75	
7/8 - 11	19,268	19,909	19,75	
1" - 10	22,149	22,835	22,75	

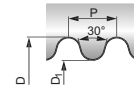
Rd Gwint okrągły PN-84/M-02035 i DIN 405

Wymiar nominalny		D ₁ (7H)		 mm
D x P/1" (tpi)	min. mm	max. mm	mm	
Rd 8 x 10	5,714	6,164	6	
	9 x 10	6,714	7,164	7
	10 x 10	7,714	8,164	8
	11 x 10	8,714	9,164	9
	12 x 10	9,714	10,164	10
	14 x 8	11,142	11,672	11,5
	16 x 8	13,142	13,672	13,5
	18 x 8	15,142	15,672	15,5
	20 x 8	17,142	17,672	17,5
	22 x 8	19,142	19,672	19,5
	24 x 8	21,142	21,672	21,5
	26 x 8	23,142	23,672	23,5
	28 x 8	25,142	25,672	25,5
	30 x 8	27,142	27,672	27,5

BSW

Wymiar nominalny		D ₁		 mm
D - P/1" (tpi)	min. mm	max. mm	mm	
BSW 1/16 - 60	1,045	1,230	1,15	
3/32 - 48	1,704	1,912	1,85	
1/8 - 40	2,362	2,591	2,55	
5/32 - 32	2,952	3,214	3,2	
3/16 - 24	3,406	3,744	3,7	
7/32 - 24	4,201	4,539	4,5	
1/4 - 20	4,724	5,156	5,1	
5/16 - 18	6,129	6,589	6,5	
3/8 - 16	7,493	7,988	7,9	
7/16 - 14	8,791	9,332	9,25	
1/2 - 12	9,987	10,589	10,5	
9/16 - 12	11,575	12,177	12	
5/8 - 11	12,918	13,559	13,5	
3/4 - 10	15,799	16,485	16,4	
7/8 - 9	18,613	19,355	19,25	
1" - 8	21,336	22,149	22	
1 1/8 - 7	23,927	24,831	24,75	
1 1/4 - 7	27,102	28,006	27,75	
1 3/8 - 6	29,504	30,528	30,5	
1 1/2 - 6	32,680	33,703	33,5	
1 5/8 - 5	34,769	35,963	35,5	
1 3/4 - 5	37,943	39,136	39	
1 7/8 - 4 1/2	40,396	41,702	41,5	
2" - 4 1/2	43,571	44,877	44,5	

Otwór cylindryczny bez zastosowania rozwiertaka

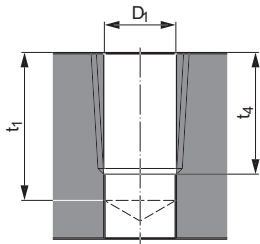

Otwór cylindryczny rozwierany rozwiertakiem stożkowym

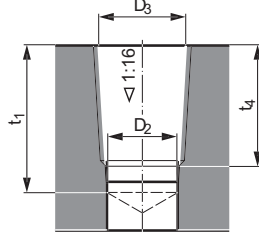

Otwór wstępny zalecany przy otworach nieprzelotowych

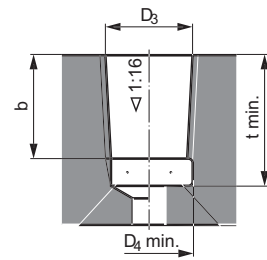

Rc (BSPT)



Gwint rurowy stożkowy Whitwortha wewnętrzny

Wymiar nominalny	D ₁	t ₁	t ₂
D - P/1" (tpi)	mm	mm	mm
Rc1/16 - 28	6,15	11,1	9,5
1/8 - 28	8,15	11,1	9,5
1/4 - 19	10,85	16,3	14
3/8 - 19	14,3	16,7	14,4
1/2 - 14	17,8	22,3	19,1
3/4 - 14	23,2	23,6	20,4
1" - 11	29,2	28,3	24,3

Wymiar nominalny	D ₂	D ₃ (JS11)	t ₁	t ₂
D - P/1" (tpi)	mm	mm	mm	mm
Rc1/16 - 28	6,1	6,56	11,1	9,5
1/8 - 28	8,1	8,57	11,1	9,5
1/4 - 19	10,75	11,45	16,3	14
3/8 - 19	14,25	14,95	16,7	14,4
1/2 - 14	17,7	18,63	22,3	19,1
3/4 - 14	23,1	24,12	23,6	20,4
1" - 11	29,1	30,29	28,3	24,3

Wymiar nominalny	D ₃ (JS11)	b	t min.	D ₄ min.
D - P/1" (tpi)	mm	mm	mm	mm
Rc1/16 - 28	6,56	5,6	9,9	7,6 ^{+0,3}
1/8 - 28	8,57	5,6	9,9	9,6 ^{+0,3}
1/4 - 19	11,45	8,4	14,6	13 ^{+0,5}
3/8 - 19	14,95	8,8	15	16,5 ^{+0,5}
1/2 - 14	18,63	11,4	20	20,6 ^{+0,5}
3/4 - 14	24,12	12,7	21,3	26 ^{+0,5}
1" - 11	30,29	14,5	25,4	32,8 ^{+0,5}

NPT



Gwint amerykański rurowy stożkowy ANSI/ASME B1.20.1

Wymiar nominalny	D ₁	t ₁	t ₂
D - P/1" (tpi)	mm	mm	mm
1/16 - 27	6,15	11,8	9,7
1/8 - 27	8,5	11,9	9,75
1/4 - 18	11	17,4	14,25
3/8 - 18	14,4	17,7	14,55
1/2 - 14	17,8	23,1	19
3/4 - 14	23,15	23,6	19,5
1" - 11 1/2	29,05	28,4	23,4
1 1/4 - 11 1/2	37,8	28,9	23,9
1 1/2 - 11 1/2	43,85	28,9	23,9
2" - 11 1/2	55,85	29,3	24,35

Wymiar nominalny	D ₂	D ₃ +0,05	t ₁	t ₂
D - P/1" (tpi)	mm	mm	mm	mm
1/16 - 27	5,95	6,39	11,8	9,7
1/8 - 27	8,3	8,74	11,9	9,75
1/4 - 18	10,75	11,36	17,4	14,25
3/8 - 18	14,15	14,8	17,7	14,55
1/2 - 14	17,45	18,32	23,1	19
3/4 - 14	22,8	23,67	23,6	19,5
1" - 11 1/2	28,65	29,69	28,4	23,4
1 1/4 - 11 1/2	37,35	38,45	28,9	23,9
1 1/2 - 11 1/2	43,45	44,52	28,9	23,9
2" - 11 1/2	55,45	56,56	29,3	24,35

Wymiar nominalny	D ₃ +0,05	b	t min.	D ₄ min.
D - P/1" (tpi)	mm	mm	mm	mm
1/16 - 27	6,39	7	10	7,6
1/8 - 27	8,74	7	10	10
1/4 - 18	11,36	10,2	14,5	13,1
3/8 - 18	14,8	10,6	15	16,5
1/2 - 14	18,32	13,8	19	20,5
3/4 - 14	23,67	14,2	20	25,8
1" - 11 1/2	29,69	17	24	32,2
1 1/4 - 11 1/2	38,45	17,5	24,5	41
1 1/2 - 11 1/2	44,52	17,5	24,5	47,2
2" - 11 1/2	56,56	18	25	59,2

NPTF



Gwint amerykański rurowy stożkowy ze szczelnością uzyskiwaną na gwincie ANSI B 1.2.4

Wymiar nominalny	D ₁	t ₁	t ₂
D - P/1" (tpi)	mm	mm	mm
1/16 - 27	6,1	13	10,65
1/8 - 27	8,45	13	10,7
1/4 - 18	10,9	19,2	15,65
3/8 - 18	14,3	19,5	16
1/2 - 14	17,6	25,4	20,85
3/4 - 14	23	25,9	21,3
1" - 11 1/2	28,75	31,1	25,6
1 1/4 - 11 1/2	37,5	31,7	26,15
1 1/2 - 11 1/2	43,75	31,7	26,15
2" - 11 1/2	55,75	32,1	26,55

Wymiar nominalny	D ₂	D ₃ +0,05	t ₁	t ₂
D - P/1" (tpi)	mm	mm	mm	mm
1/16 - 27	5,95	6,41	13	10,65
1/8 - 27	8,3	8,76	13	10,7
1/4 - 18	10,75	11,4	19,2	15,65
3/8 - 18	14,15	14,84	19,5	16
1/2 - 14	17,45	18,33	25,4	20,85
3/4 - 14	22,8	23,68	25,9	21,3
1" - 11 1/2	28,65	29,72	31,1	25,6
1 1/4 - 11 1/2	37,35	38,48	31,7	26,15
1 1/2 - 11 1/2	43,45	44,55	31,7	26,15
2" - 11 1/2	55,45	56,59	32,1	26,55

Wymiar nominalny	D ₃ +0,05	b	t min.	D ₄ min.
D - P/1" (tpi)	mm	mm	mm	mm
1/16 - 27	6,41	8	11	7,4
1/8 - 27	8,76	8	11	9,8
1/4 - 18	11,4	11,6	15,5	12,9
3/8 - 18	14,84	12	16	16,3
1/2 - 14	18,33	15,6	20,5	20,3
3/4 - 14	23,68	16	21,5	25,6
1" - 11 1/2	29,72	19,2	26	32
1 1/4 - 11 1/2	38,48	19,7	26,5	40,8
1 1/2 - 11 1/2	44,55	19,7	26,5	47
2" - 11 1/2	56,59	20,2	27	59

MJ MJ gwint DIN ISO 5855



Wymiar nominalny		D ₁		
D mm	P mm	min. mm	max. mm	
MJ 3	x 0,5	2,513	2,653	2,6
4	x 0,7	3,318	3,498	3,4
5	x 0,8	4,221	4,421	4,3
6	x 1	5,026	5,216	5,1
8	x 1	7,026	7,216	7,1
8	x 1,25	6,782	6,994	6,9
10	x 1,25	8,782	8,994	8,9
10	x 1,5	8,539	8,775	8,6

UNJF Gwint zunifikowany drobnozwojny ASME B1.15

Wymiar nominalny		D ₁		
D cal	P/1" (tpi)	min. mm	max. mm	
Nr. 4	- 48	2,329	2,466	2,4
Nr. 6	- 40	2,888	3,053	3
Nr. 8	- 36	3,480	3,663	3,55
Nr. 10	- 32	4,054	4,255	4,15
1/4	- 28	5,466	5,662	5,55
5/16	- 24	6,906	7,109	7
3/8	- 24	8,494	8,679	8,6

UNJC Gwint znikfikowany ASME B1.15

Wymiar nominalny		D ₁		
D cal	P/1" (tpi)	min. mm	max. mm	
Nr. 4	- 40	2,228	2,393	2,3
Nr. 6	- 32	2,733	2,939	2,85
Nr. 8	- 32	3,393	3,599	3,5
Nr. 10	- 24	3,795	4,064	3,9
1/4	- 20	5,113	5,387	5,25
5/16	- 18	6,563	6,833	6,7
3/8	- 16	7,978	8,255	8,1

Gwint do rurek instalacyjnych

Pg Gwint do rurek instalacyjnych DIN 40430

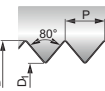

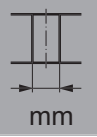
Wymiar nominalny		D ₁		
D mm	P/1" (tpi)	min. mm	max. mm	
Pg 7	20	11,28	11,43	11,35
9	18	13,86	14,01	13,95
11	18	17,26	17,41	17,35
13,5	18	19,06	19,21	19,15
16	18	21,16	21,31	21,25
21	16	26,78	27,03	26,95
29	16	35,48	35,73	35,6
36	16	45,48	45,73	45,6
42	16	52,48	52,73	52,6
48	16	57,78	58,03	57,9

EG M(STI) ISO Gwint metryczny zwykły DIN 8140-2

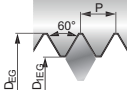

Wymiar nominalny		D _{EG}	D _{1EG}		
D mm	P mm	min. mm	min. mm	max. mm	
EG M2,5	0,45	3,084	2,597	2,697	2,65
3	0,5	3,650	3,108	3,220	3,15
4	0,7	4,910	4,152	4,292	4,2
5	0,8	6,040	5,174	5,334	5,25
6	1	7,300	6,217	6,407	6,3
8	1,25	9,624	8,271	8,483	8,4
10	1,5	11,948	10,324	10,560	10,5
12	1,75	14,274	12,379	12,644	12,5
14	2	16,598	14,433	14,733	14,5
16	2	18,598	16,433	16,733	16,5
18	2,5	21,248	18,541	18,896	18,75
20	2,5	23,248	20,541	20,896	20,75

EG UNC (STI) Gwint zunifikowany ASME B18.29.1

Wymiar nominalny		D _{EG}	D _{1EG}		
D mm	P/1" (tpi)	min. mm	min. mm	max. mm	
EGNr. 4	- 40	3,671	2,982	3,178	3,1
Nr. 6	- 32	4,536	3,678	3,879	3,8
Nr. 8	- 32	5,197	4,338	4,523	4,4
Nr. 10	- 24	6,200	5,054	5,283	5,2
1/4	- 20	8,002	6,628	6,872	6,7
5/16	- 18	9,771	8,244	8,490	8,4
3/8	- 16	11,587	9,867	10,126	10
7/16	- 14	13,469	11,506	11,783	11,6
1/2	- 13	15,237	13,121	13,393	13,3
9/16	- 12	17,039	14,747	15,031	14,9
5/8	- 11	18,875	16,376	16,673	16,5
3/4	- 10	22,349	19,598	19,908	19,75

EG UNF (STI) Gwint zunifikowany ASME B18.29.1

Wymiar nominalny		D _{EG}	D _{1EG}		
D mm	P/1" (tpi)	min. mm	min. mm	max. mm	
EGNr. 4	- 48	3,533	2,959	3,119	3
Nr. 6	- 40	4,330	3,642	3,815	3,7
Nr. 8	- 36	5,083	4,318	4,496	4,4
Nr. 10	- 32	5,858	4,999	5,184	5,1
1/4	- 28	7,528	6,545	6,720	6,6
5/16	- 24	9,312	8,166	8,351	8,25
3/8	- 24	10,899	9,753	9,931	9,8
7/16	- 20	12,763	11,389	11,587	11,5
1/2	- 20	14,352	12,978	13,176	13,1
9/16	- 18	16,121	14,594	14,800	14,7
5/8	- 18	17,709	16,182	16,388	16,25
3/4	- 16	21,112	19,392	19,608	19,5

ZARYS GWINTU STOŻKOWEGO ZEWNĘTRZNEGO NPT

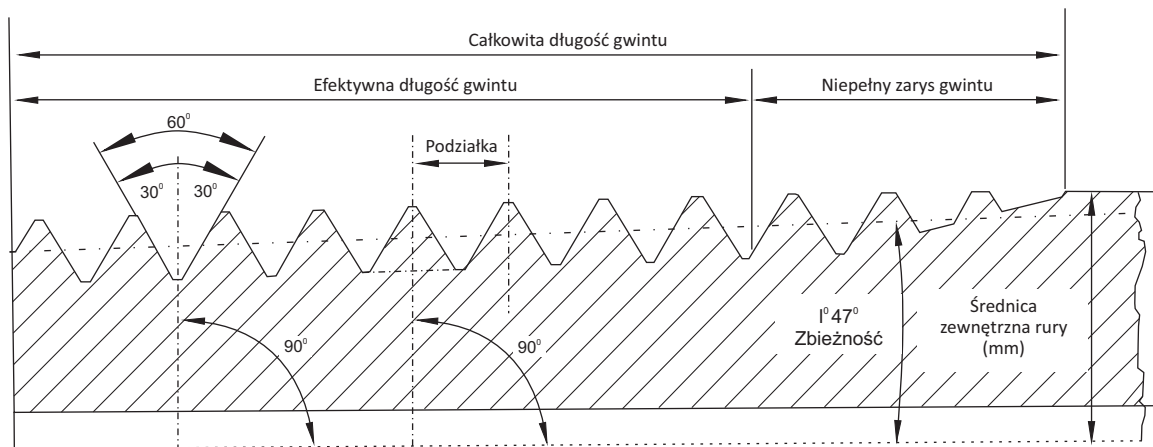

Średnica gwintu (cal)	Skok gwintu (T.P.I)	Średnica zewnętrzna rury (mm)	Całkowita długość gwintu (mm)
1/16	27	7,950	9,896
1/8	27	10,287	9,967
1/4	18	13,716	15,103
3/8	18	17,145	15,255
1/2	14	21,336	19,850
3/4	14	26,670	20,155
1	11.1/2	33,401	25,006
1.1/4	11.1/2	42,164	25,616
1.1/2	11.1/2	48,260	26,040
2	11.1/2	60,325	26,878
2.1/2	8	73,025	39,908
3	8	88,900	41,496
3.1/2	8	101,600	42,766
4	8	114,300	44,036

11.3. Zalecane średnice otworów pod wygniataki

M

Wymiar nominalny		
D mm	P mm	
M 1	0,25	0,9
1,1	0,25	1
1,2	0,25	1,1
1,4	0,3	1,28
1,6	0,35	1,47
1,7	0,35	1,57
1,8	0,35	1,67
2	0,4	1,85
2,2	0,45	2,03
2,3	0,4	2,15
2,5	0,45	2,33
2,6	0,45	2,43
3	0,5	2,8
3,5	0,6	3,25
4	0,7	3,7
4,5	0,75	4,2
5	0,8	4,65
5,5	0,9	5,1
6	1	5,6
7	1	6,6
8	1,25	7,45
9	1,25	8,45
10	1,5	9,35
12	1,75	11,25
14	2	13,1
16	2	15,1
18	2,5	16,85
20	2,5	18,85
22	2,5	20,85
24	3	22,65
27	3	25,65
30	3,5	28,4
33	3,5	31,4
36	4	34,15
39	4	37,15
42	4,5	39,9
45	4,5	42,9
48	5	45,65

MF

Wymiar nominalny		
D mm	x P mm	
M 2,5 x	0,35	2,37
2,6 x	0,35	2,47
3 x	0,35	2,88
3,5 x	0,35	3,38
4 x	0,5	3,8
5 x	0,5	4,8
6 x	0,5	5,8
6 x	0,75	5,7
7 x	0,75	6,7
8 x	0,75	7,7
8 x	1	7,6
9 x	0,75	8,7
9 x	1	8,6
10 x	0,75	9,7
10 x	1	9,6
10 x	1,25	9,45
11 x	1	10,6
12 x	1	11,6
12 x	1,25	11,45
12 x	1,5	11,35
14 x	1	13,6
14 x	1,25	13,45
14 x	1,5	13,35
15 x	1	14,6
15 x	1,5	14,35
16 x	1	15,6
16 x	1,5	15,35
18 x	1	17,6
18 x	1,5	17,35
18 x	2	17,1
20 x	1	19,6
20 x	1,5	19,35
20 x	2	19,1
24 x	2	23,1
30 x	2	29,1
36 x	3	34,65
42 x	4	40,15
48 x	3	46,65

UNC

Wymiar nominalny		
D cal	P/1" (tpi)	
Nr. 4 -	40	2,55
Nr. 5 -	40	2,9
Nr. 6 -	32	3,15
Nr. 8 -	32	3,8
Nr. 10 -	24	4,35
Nr. 12 -	24	5
1/4 -	20	5,75
3/8 -	16	8,8
7/16 -	14	10,25
1/2 -	13	11,8
9/16 -	12	13,3
5/8 -	11	14,8
3/4 -	10	17,85
7/8 -	9	20,9
1" -	8	23,9

UNF

Wymiar nominalny		
D cal	P/1" (tpi)	
Nr. 2 -	64	2,02
Nr. 3 -	56	2,32
Nr. 4 -	48	2,62
Nr. 5 -	44	2,92
Nr. 6 -	40	3,22
Nr. 8 -	36	3,85
Nr. 10 -	32	4,45
Nr. 12 -	28	5,1
1/4 -	28	5,95
5/16 -	24	7,45
3/8 -	24	9,05
7/16 -	20	10,55
1/2 -	20	12,15
9/16 -	18	13,65
5/8 -	18	15,25
3/4 -	16	18,35
7/8 -	14	21,4
1" -	12	24,45

G

Wymiar nominalny		
D cal	P/1" (tpi)	
G 1/16 -	28	7,25
1/8 -	28	9,25
1/4 -	19	12,55
3/8 -	19	16,05
1/2 -	14	20,1
5/8 -	14	22,05
3/4 -	14	25,6
7/8 -	14	29,35
1" -	11	32,15

11.4. Wzory do obliczania parametrów technologicznych przy wierceniu i gwintowaniu

Zależność prędkości obrotowej od prędkości obwodowej i średnicy narzędzia

Prędkość skrawania V_c [m/min]

$$v_c = \frac{d_1 \times \pi \times n}{1000}$$

Prędkość obrotowa wrzeciona n [obr/min]

$$n = \frac{1000 \times v_c}{d_1 \times \pi}$$

Prędkość posuwu V_f [mm/min]

- przy gwintowaniu

$$v_f = p \times n$$

- przy wierceniu

$$v_f = f_o \times n$$

$$f_o = \frac{v_f}{n}$$

Moment obrotowy przy gwintowaniu M_d [Nm]

$$M_d = \frac{p^2 \times d_1 \times k_c}{8000}$$

Moment obrotowy przy wierceniu M_c [Nm]

$$M_c = \frac{F_c \times z \times d_1}{4000}$$

Siła skrawania przypadająca na jedno ostrze F_c [N]

$$F_c = \frac{d_1 \times f_o \times k_c}{2}$$

Moc P [kW]

$$P = \frac{M_{c,d} \times 2 \times \pi \times n}{60000}$$

Objaśnienia:

d_1 - średnica nominalna narzędzia [mm]

v_c - prędkość skrawania [m/min]

n - prędkość obrotowa wrzeciona [obr/min]

p - skok gwintu [mm]

P - moc [kW]

v_f - prędkość posuwu [m/min]

f_o - posuw na obrot [mm/obr]

k_c - opór właściwy obrabianego materiału [MPa]

M_d - moment obrotowy przy gwintowaniu [Nm]

z - liczba ostrzy

11.5. Zalecane średnice prętów do nacinania gwintów narzynkami

M	
GWINT	ø d
M 1	0,96
M 1,1	1,05
M 1,2	1,15
M 1,4	1,35
M 1,6	1,55
M 1,8	1,75
M 2	1,95
M 2,2	2,15
M 2,5	2,42
M 3	2,92
M 3,5	3,41
M 4	3,90
M 4,5	4,40
M 5	4,90
M 6	5,88
M 7	6,88
M 8	7,86
M 9	8,86
M 10	9,85
M 11	10,85
M 12	11,83
M 14	13,82
M 16	15,82
M 18	17,79
M 20	19,79
M 22	21,79
M 24	23,76
M 27	26,76
M 30	29,73
M 33	32,73
M 36	35,70
M 39	38,70
M 42	41,68
M 45	44,68
M 48	47,66
M 52	51,66
M 56	55,65
M 60	59,65
M 64	63,62
M 68	67,62

MF	
GWINT	ø d
M3,5x0,5	3,43
M4x0,5	3,92
M4,5x0,5	4,43
M5x0,5	4,92
M5x0,75	4,91
M5,5x0,5	5,43
M5,5x0,75	5,42
M6x0,5	5,92
M6x0,75	5,90
M7x0,75	6,90
M8x0,5	7,92
M8x0,75	7,90
M8x1	7,88
M9x0,75	8,90
M9x1	8,88
M10x0,75	9,90
M10x1	9,88
M10x1,25	9,86
M11x0,75	10,91
M11x1	10,88
M12x1	11,88
M12x1,25	11,86
M12x1,5	11,85
M14x1	13,88
M14x1,5	13,85

MF cd.	
GWINT	ø d
M15x1	14,88
M15x1,5	14,85
M16x1	15,88
M16x1,5	15,85
M17x1	16,88
M17x1,5	16,85
M18x1	17,88
M18 x1,5	17,85
M18x2	17,82
M20x1	19,88
M20x1,5	19,85
M20x2	19,82
M22x1	21,88
M22x1,5	21,85
M22x2	21,82
M24x1	23,88
M24x1,5	23,85
M24x2	23,82
M25x1	24,88
M25x1,5	24,85
M25x2	24,82
M26x1,5	25,85
M27x1	26,88
M27x1,5	26,85
M27x2	26,82
M28x1	27,88
M28x1,5	27,85
M28x2	27,82
M30x1	29,88
M30x1,5	29,85
M30x2	29,82
M30x3	29,76
M32x1,5	31,85
M32x2	31,82
M33x1,5	32,85
M33x2	32,82
M33x3	32,76
M35x1,5	34,85
M36x1,5	35,85
M36x2	35,82
M36x3	35,76
M38x1,5	37,85
M39x1,5	38,85
M39x2	38,82
M39x3	38,76
M40x1,5	39,85
M40x2	39,82
M40x3	39,76
M42x1,5	41,85
M42x2	41,82
M42x3	41,76
M45x1,5	44,85
M45x2	44,82
M45x3	44,76
M48x1,5	47,85
M48x2	47,82
M48x3	47,76
M48x4	47,73
M50x1,5	49,85
M50x2	49,82
M50x3	49,76
M52x1,5	51,85
M52x2	51,82
M52x3	51,76
M52x4	51,73
M55x1,5	54,85
M55x2	54,82
M55x3	54,76
M55x4	54,73
M56x1,5	55,85
M56x2	55,82
M56x3	55,76
M56x4	55,73

G	
GWINT	ø d
G - 1/8"	9,62
G - 1/4"	13,03
G - 3/8"	16,54
G - 1/2"	20,81
G - 5/8"	22,77
G - 3/4"	26,30
G - 7/8"	30,06
G - 1"	33,07
G - 1.1/8"	37,72
G - 1.1/4"	41,73
G - 1.3/8"	44,14
G - 1.1/2"	47,62
G - 1.3/4"	53,57
G - 2"	59,43
G - 2.1/4"	65,49

BSW	
GWINT	ø d
1/8 - 40	3,09
3/16 - 24	4,66
1/4 - 20	6,24
5/16 - 18	7,82
3/8 - 16	9,40
7/16 - 14	10,98
1/2 - 12	12,56
9/16 - 12	14,14
5/8 - 11	15,72
3/4 - 10	18,89
7/8 - 9	22,10
1 - 8	25,27

NPT	
GWINT	ø d
1/8"	9,99
1/4"	13,26
3/8"	16,67
1/2"	20,71
3/4"	26,03
1"	32,59

UNC	
GWINT	ø d
No 5 - 40	3,09
No 6 - 32	3,41
No 8 - 32	4,07
No 10 - 24	4,71
No 12 - 24	5,37
1/4 - 20	6,22
5/16 - 18	7,80
3/8 - 16	9,37
7/16 - 14	10,95
1/2 - 13	12,52
9/16 - 12	14,10
5/8 - 11	15,68
3/4 - 10	18,84
7/8 - 9	22,00
1 - 8	25,16
1.1/8 - 7	28,31
1.1/4 - 7	31,49
1.3/8 - 6	34,63
1.1/2 - 6	37,80
1.3/4 - 5	44,12
2 - 4.1/2	50,45

UNF	
GWINT	ø d
No 5 - 44	3,10
No 6 - 40	3,42
No 8 - 36	4,08
No 10 - 32	4,73
No 12 - 28	5,38
1/4 - 28	6,24
5/16 - 24	7,82
3/8 - 24	9,41
7/16 - 20	10,98
1/2 - 20	12,56
9/16 - 18	14,14
5/8 - 18	15,73
3/4 - 16	18,89
7/8 - 14	22,05
1 - 12	25,21
1.1/8 - 12	28,38
1.1/4 - 12	31,55
1.3/8 - 12	34,73
1.1/2 - 12	37,90

R	
GWINT	ø d
R - 1/8"	9,48
R - 1/4"	12,78
R - 3/8"	16,26
R - 1/2"	20,44
R - 3/4"	25,85
R - 1"	32,60

BSF	
GWINT	ø d
3/16 - 32	4,76
1/4 - 26	6,25
5/16 - 22	7,83
3/8 - 20	9,41
7/16 - 18	10,99
1/2 - 16	12,57
9/16 - 16	14,16
5/8 - 14	15,73
3/4 - 12	18,89
7/8 - 11	22,11
1 - 10	25,28

Pg	
GWINT	ø d
Pg 7	12,40
Pg 9	15,10
Pg 11	18,50
Pg 13,5	20,30
Pg 16	22,40
Pg 21	28,15
Pg 29	36,85
Pg 36	46,85
Pg 42	53,85
Pg 48	59,15

11.6. Zależność prędkości obrotowej od prędkości obwodowej i średnicy narzędzia

Ød ₁ [mm]	$V = \pi \cdot d_1 n / 1000$ [m/min]														
	2	3	4	5	6	8	10	12	15	18	20	25	30	35	40
3	212	318	424	531	637	849	1061	1273	1592	1910	2122	2653	3183	3714	4244
3,5	182	273	364	455	546	728	909	1091	1364	1637	1819	2274	2728	3183	3638
4	159	239	318	398	477	637	796	955	1194	1432	1592	1989	2387	2785	3183
4,5	141	212	283	354	424	566	707	849	1061	1273	1415	1768	2122	2476	2829
5	127	191	255	318	382	509	637	764	955	1146	1273	1592	1910	2228	2546
6	106	159	212	265	318	424	531	637	796	955	1061	1326	1592	1857	2122
7	91	136	182	227	273	364	455	546	682	819	909	1137	1364	1592	1819
8	80	119	159	199	239	318	398	477	597	716	796	995	1194	1393	1592
9	71	106	141	177	212	283	354	424	531	673	707	884	1061	1238	1415
10	64	95	127	159	191	255	318	382	477	573	637	796	955	1114	1273
11	58	87	116	145	174	231	289	347	434	521	579	723	868	1013	1157
12	53	80	106	133	159	212	265	318	398	477	531	663	796	928	1061
14	45	68	91	114	136	182	227	273	341	409	455	568	682	796	909
16	40	60	80	99	119	159	199	239	298	358	398	497	597	696	796
18	35	53	71	88	106	141	177	212	265	318	354	442	531	619	707
20	32	48	64	80	95	127	159	191	239	286	318	398	477	557	637
22	29	43	58	72	87	116	145	174	217	260	289	362	434	506	579
24	27	40	53	66	80	106	133	159	199	239	265	332	398	464	531
27	24	35	47	59	71	94	118	141	177	212	236	295	354	413	472
30	21	32	42	53	64	85	106	127	159	191	212	265	318	371	424
33	19	29	39	48	58	77	96	116	145	174	193	241	289	338	386
36	18	27	35	44	53	71	88	106	133	159	177	221	265	309	354
39	16	24	33	41	49	65	82	98	122	147	163	204	245	286	326
42	15	23	30	38	45	61	76	91	114	136	152	189	227	265	303
45	14	21	28	35	42	57	71	85	106	127	141	177	212	248	283
48	13	20	27	33	40	53	66	80	99	119	133	166	199	232	265
52	12	18	24	31	37	49	61	73	92	110	122	153	184	214	245

 ZALEŻNOŚĆ WYTRZYMAŁOŚCI R_m, HRC, HB, HV 10

R _m [MPa]	HRC	HB	HV 10	R _m [MPa]	HRC	HB	HV 10	R _m [MPa]	HRC	HB	HV 10
240		71	75	690		204	215	1360	43	402	423
255		76	80	705		209	220	1400	44	413	434
270		81	85	720		214	225	1440	45	424	446
285		86	90	740		219	230	1480	46	435	458
305		90	95	755		223	235	1530	47	449	473
320		95	100	770		228	240	1570	48	460	484
335		100	105	785		233	245	1620	49	472	497
350		105	110	800	22	238	250	1680	50	488	514
370		109	115	820	23	242	255	1730	51	501	527
385		114	120	835	24	247	260	1890	52	517	544
400		119	125	860	25	255	268	1845	53	532	560
415		124	130	870	26	258	272	1910	54	549	578
430		128	135	900	27	266	280	1980	55	567	596
450		133	140	920	28	273	287	2050	56	584	615
465		138	145	940	29	278	293	2140	57	607	639
480		143	150	970	30	287	302		58	622	655
495		147	155	995	31	295	310		59		675
510		152	160	1020	32	301	317		60		698
530		157	165	1050	33	311	327		61		720
545		162	170	1080	34	319	336		62		745
560		166	175	1110	35	328	345		63		773
575		171	180	1140	36	337	355		64		800
595		176	185	1170	37	346	364		65		829
610		181	190	1200	38	354	373		66		864
625		185	195	1230	39	363	382		67		900
640		190	200	1260	40	372	392		68		940
660		195	205	1300	41	383	403				
675		199	210	1330	42	393	413				

11.7. Wymiary graniczne średnicy podziałowej gwintu wewnętrznego

Gwint metryczny ISO

Wymiar nominalny		6H		6G	
M	MF	min	max	min	max
M 2		1,740	1,830	1,759	1,849
M 2,2		1,908	2,003	1,928	2,023
M 2,5		2,208	2,303	2,228	2,323
M 3		2,675	2,775	2,695	2,795
M 3,5		3,110	3,222	3,131	3,243
M 4		3,545	3,663	3,567	3,685
	M 4x0,5	3,675	3,775	3,695	3,795
M 4,5		4,013	4,131	4,035	4,153
M 5		4,480	4,605	4,504	4,629
	M 5x0,5	4,675	4,775	4,695	4,795
M 6		5,350	5,500	5,376	5,526
	M 6x0,75	5,513	5,645	5,535	5,667
M 7		6,350	6,500	6,376	6,526
M 8		7,188	7,348	7,216	7,376
	M 8x0,75	7,513	7,645	7,535	7,667
	M 8x1	7,350	7,500	7,376	7,526
M 9		8,188	8,348	8,216	8,376
M 10		9,026	9,206	9,058	9,238
	M 10x0,75	9,513	9,645	9,535	9,667
	M 10x1	9,350	9,500	9,376	9,526
	M 10x1,25	9,188	9,348	9,216	9,376
M 12		10,863	11,063	10,897	11,097
	M 12x1	11,350	11,510	11,376	11,536
	M 12x1,25	11,188	11,368	11,216	11,396
	M 12x1,5	11,026	11,216	11,058	11,248
M 14		12,701	12,913	12,739	12,951
	M 14x1,5	13,026	13,216	13,058	13,248
M 16		14,701	14,913	14,739	14,951
	M 16x1,5	15,026	15,216	15,058	15,248
M 18		16,376	16,600	16,418	16,642
	M 18x1,5	17,026	17,216	17,058	17,248
M 20		18,376	18,600	18,418	18,642
	M 20x1,5	19,026	19,216	19,058	19,248
	M 20x2	18,701	18,913	18,739	18,951
M 22		20,376	20,600	20,418	20,642
	M 22x1,5	21,026	21,216	21,058	21,248
M 24		22,051	22,316	22,099	22,364
	M 24x1,5	23,026	23,226	23,058	23,258
	M 24x2	22,701	22,925	22,739	22,963
	M 26x1,5	25,026	25,226	25,058	25,258
M 27		25,051	25,316	25,099	25,364
	M 27x1,5	26,026	26,226	26,058	26,258
	M 27x2	25,701	25,925	25,739	25,963
	M 28x1,5	27,026	27,226	27,058	27,258
M 30		27,727	28,007	27,780	28,060
	M 30x1,5	29,026	29,226	29,058	29,258
	M 30x2	28,701	28,925	28,739	28,963
	M 32x1,5	31,026	31,226	31,058	31,258
	M 32x2	30,701	30,925	30,739	30,963
M 33		30,727	31,007	30,780	31,060
	M 33x1,5	32,026	32,226	32,058	32,258
	M 33x2	31,701	31,925	31,739	31,963
M 36		33,402	33,702	33,462	33,762
	M 36x1,5	35,026	35,226	35,058	35,258
	M 36x2	34,701	34,925	34,739	34,963
	M 36x3	34,051	34,316	34,099	34,364
M 39		36,402	36,702	36,462	36,762
	M 39x1,5	38,026	38,226	38,058	38,258
	M 39x2	37,701	37,925	37,739	37,963
	M 39x3	37,051	37,316	37,099	37,364
	M 40x1,5	39,026	39,226	39,058	39,258
M 42		39,077	39,392	39,140	39,455
	M 42x1,5	41,026	41,226	41,058	41,258
	M 42x2	40,701	40,925	40,739	40,963
	M 42x3	40,051	40,316	40,099	40,364
M 45		42,077	42,392	42,140	42,455
	M 45x1,5	44,026	44,226	44,058	44,258
	M 45x2	43,701	43,925	43,739	43,963
	M 45x3	43,051	43,316	43,099	43,364
M 48		44,752	45,087	44,823	45,158
	M 48x1,5	47,026	47,238	47,058	47,270
	M 48x2	46,701	46,937	46,739	46,975
	M 48x3	46,051	46,331	46,099	46,379
M 52		48,752	49,087	48,823	49,158
	M 52x2	50,701	50,937	50,739	50,975
	M 52x3	50,051	50,331	50,099	50,379

Gwint amerykański zunifikowany UNC i UNF

Wymiar nominalny		2B / 3B	2B	3B
UNC	UNF	min	max	max
No 5 - 40		2,764	2,847	2,827
	No 5 - 44	2,799	2,880	2,860
No 6 - 32		2,990	3,084	3,058
	No 6 - 40	3,094	3,180	3,157
No 8 - 32		3,650	3,746	3,721
	No 8 - 36	3,708	3,800	3,777
No 10 - 24		4,138	4,247	4,219
	No 10 - 32	4,310	4,409	4,384
No 12 - 24		4,798	4,910	4,882
	No 12 - 28	4,897	5,004	4,976
1/4 - 20		5,524	5,648	5,616
	1/4 - 28	5,761	5,870	5,842
5/16 - 18		7,021	7,155	7,120
	5/16 - 24	7,249	7,371	7,341
3/8 - 16		8,494	8,639	8,603
	3/8 - 24	8,837	8,961	8,931
7/16 - 14		9,934	10,089	10,051
	7/16 - 20	10,287	10,424	10,391
1/2 - 13		11,430	11,595	11,552
	1/2 - 20	11,874	12,017	11,981
9/16 - 12		12,913	13,086	13,043
	9/16 - 18	13,371	13,520	13,482
5/8 - 11		14,376	14,559	14,514
	5/8 - 18	14,958	15,110	15,072
3/4 - 10		17,399	17,595	17,544
	3/4 - 16	18,019	18,184	18,143
7/8 - 9		20,391	20,599	20,546
	7/8 - 14	21,026	21,224	21,181
1 - 8		23,338	23,561	23,505
	1 - 12	24,026	24,224	24,171
1.1/8 - 7		26,218	26,457	26,398
	1.1/8 - 12	27,201	27,424	27,351
1.1/4 - 7		29,393	29,637	29,576
	1.1/4 - 12	30,376	30,619	30,528
1.3/8 - 6		32,174	32,438	32,372
	1.3/8 - 12	33,551	33,799	33,706
1.1/2 - 6		35,349	35,616	35,550
	1.1/2 - 12	36,726	36,937	36,886
1.3/4 - 5		41,151	41,445	41,372
2 - 4.1/2		47,135	47,450	47,371

Gwint rurowy walcowy G

Wymiar nominalny	min	max
G-1/16"	7,142	7,249
G-1/8"	9,147	9,254
G-1/4"	12,301	12,426
G-3/8"	15,806	15,931
G-1/2"	19,793	19,935
G-5/8"	21,749	21,891
G-3/4"	25,279	25,421
G-7/8"	29,039	29,181
G-1"	31,770	31,950
G-1.1/8"	36,418	36,598
G-1.1/4"	40,431	40,611
G-1.3/8"	42,844	43,024
G-1.1/2"	46,324	46,504
G-1.3/4"	52,267	52,447
G-2"	58,135	58,315

FORMULARZ DOBORU NARZĘDZIA



Wypełnia FANAR

Data wpłynięcia:..... Sprawę przyjął:..... Nr zapytania

Data:

GWINTOWNIK

WYGNIATAK

DANE KLIENTA

Nazwa i adres firmy:

Osoba kontaktowa: tel.....

1. Typ gwintu

1.1. Wymiar: 1.2. Tolerancja:

1.3. Cechy i wymiary otworu / wałka gwintowanego:

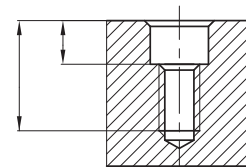
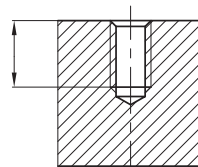
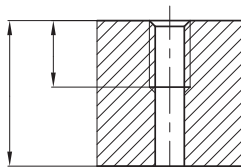
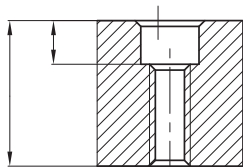
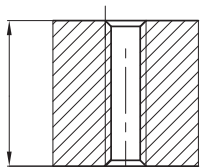

2. Obrabiarka i osprzęt do gwintowania

2.1. Typ obrabiarki:

2.2. Metoda gwintowania: poziomo pionowo 2.3. Posuw wymuszony: tak nie

2.4. Typ oprawki / uchwytu:

Kompensacja osiowa: tak nie

Kompensacja współosiowości: tak nie

Sprzęgło przeciążeniowe: tak nie

2.5. Prędkość skrawania:m/min,obr/min

2.6. Smarowanie: ręczne automatyczne Środek smarny:

3. Materiał obrabiany

3.1. Rodzaj obrabianego elementu:

3.2. Materiał (symbol):

3.3. Twardość:HBHRC; Extension strength Rm.....N/mm²

3.4. Przygotowanie otworu/wałka gwintowanego: Wiercony Rozwiercany Odlew Inny:

4. Narzędzie

4.1. Narzędzie obecnie stosowane (typ):

4.2. Żywotność:

4.3. Oczekiwane wymiary narzędzia:

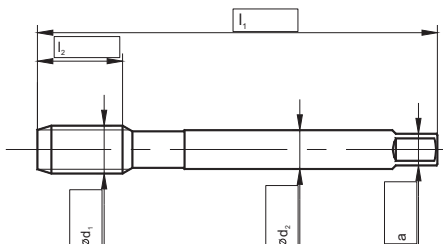

5. Uwagi

.....

Cena sugerowana:

Wypełnij w wersji online



FORMULARZ DOBORU NARZĘDZIA



Wypełnia FANAR

Data wpłynięcia:..... Sprawę przyjął:..... Nr zapytania

Data:

NARZYNKA

DANE KLIENTA

Nazwa i adres firmy:

Osoba kontaktowa:tel.....

1. Typ gwintu

1.1. Wymiar: 1.2. Tolerancja:

1.3. Cechy i wymiary otworu / wałka gwintowanego:

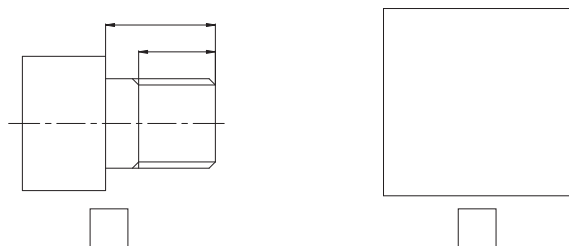

2. Obrabiarka i osprzęt do gwintowania

2.1. Typ obrabiarki:

2.2. Metoda gwintowania: poziomo pionowo 2.3. Posuw wymuszony: tak nie

2.4. Typ oprawki / uchwytu:

Kompensacja osiowa: tak nie

Kompensacja współosiowości: tak nie

Sprzęgło przeciążeniowe: tak nie

2.5. Prędkość skrawania:m/min,obr/min

2.6. Smarowanie: ręczne automatyczne Środek smarny:

3. Materiał obrabiany

3.1. Rodzaj obrabianego elementu:

3.2. Materiał (symbol):

3.3. Twardość:HBHRC; Wytrzymałość na rozciąganie Rm.....N/mm²

3.4. Przygotowanie otworu/wałka gwintowanego: Wiercony Rozwiercany Odlew Inny:

4. Narzędzie

4.1. Narzędzie obecnie stosowane (typ):

4.2. Żywotność:

4.3. Oczekiwane wymiary narzędzia:

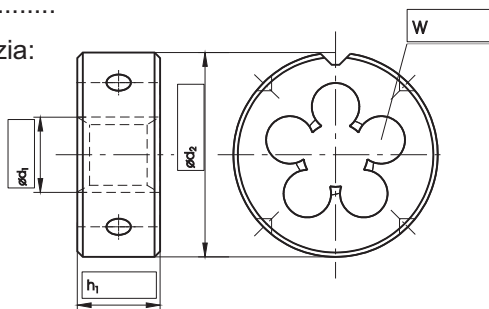

5. Uwagi

Cena sugerowana:

FORMULARZ DOBORU NARZĘDZIA



Wypełnia FANAR

Data wpłynięcia:..... Sprawę przyjął:..... Nr zapytania

Data:

WIERTŁO SPECJALNE

DANE KLIENTA

Nazwa i adres firmy:

Osoba kontaktowa: tel.....

1. Szkic obrabianej części

1.1. Nazwa detalu:..... 1.2. Materiał obrabiany:.....

1.3. Twardość:

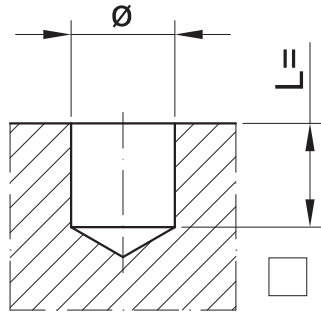

2. Narzędzie:

2.1. Nr. rysunku narzędzia:.....

2.2. Sugerowany materiał:

2.3. Sugerowana powłoka PVD:.....

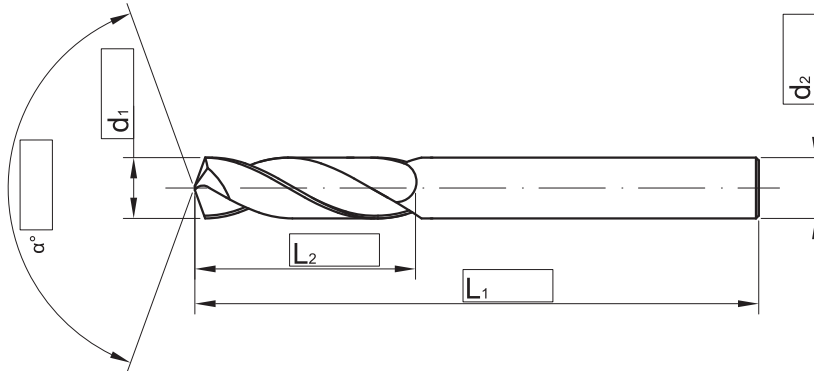

3. Wykonanie:

3.1. Rowki: prawoskrętne Lewoskrętne Proste Kąt lini śrubowej:

3.2. Kierunek Cięcia: Prawotnące Lewotnące

3.3. Chłodzenie: Zewnętrzne Wewnętrzne Bez chłodzenia

3.4. Chwył: DIN-6535-HA DIN-6535-HB DIN-65350HE

4. Maszyna:

4.1. Typ maszyny:

4.2. Typ/wielkość wrzeciona:

4.3. Moc maszyny[kW]:

4.4. Max prędkość obr[obr/min]:

5. Uwagi

Cena sugerowana:

Wypełnij w wersji online



FORMULARZ DOBORU NARZĘDZIA



Wypełnia FANAR

Data wpłynięcia:..... Sprawę przyjął:..... Nr zapytania

Data:

SPECJALNE WIERTŁO 1-STOPNIOWE

DANE KLIENTA

Nazwa i adres firmy:

Osoba kontaktowa:tel.....

1. Szkic obrabianej części

1.1. Nazwa detalu:..... 1.2. Materiał obrabiany:.....

1.3. Twardość:

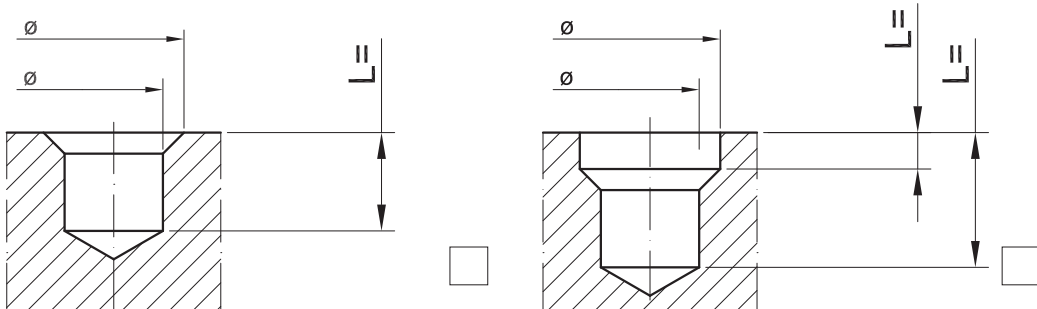

2. Narzędzie:

2.1. Nr. rysunku narzędzia:.....

2.2. Sugerowany materiał:

2.3. Sugerowana powłoka PVD:.....

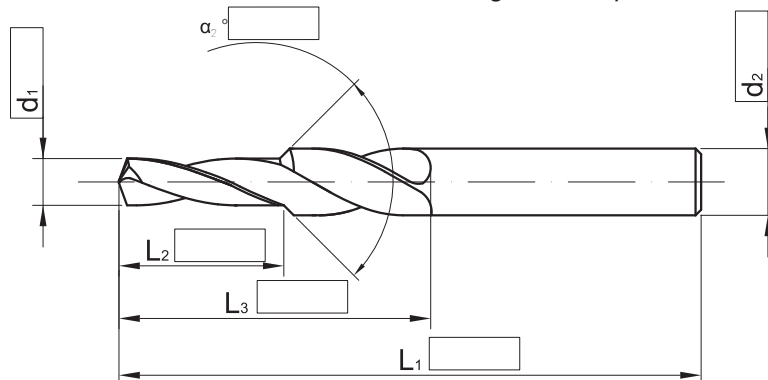

3. Wykonanie:

3.1. Rowki: prawoskrętne Lewoskrętne Proste Kąt lini śrubowej:

3.2. Kierunek Cięcia: Prawotnące Lewotnące

3.3. Chłodzenie: Zewnętrzne Wewnętrzne Bez chłodzenia

3.4. Chwył: DIN-6535-HA DIN-6535-HB DIN-65350HE

4. Maszyna:

4.1. Typ maszyny:

4.2. Typ/wielkość wrzeciona:

4.3. Moc maszyny[kW]:

4.4. Max prędkość obr[obr/min]:

5. Uwagi

.....

Cena sugerowana:

Wypełnij w wersji online



FORMULARZ DOBORU NARZĘDZIA



Wypełnia FANAR

Data wpłynięcia:..... Sprawę przyjął:..... Nr zapytania

Data:

SPECJALNE WIERTŁO 2-STOPNIOWE

DANE KLIENTA

Nazwa i adres firmy:

Osoba kontaktowa: tel.....

1. Szkic obrabianej części

1.1. Nazwa detalu:..... 1.2. Materiał obrabiany:.....

1.3. Twardość:

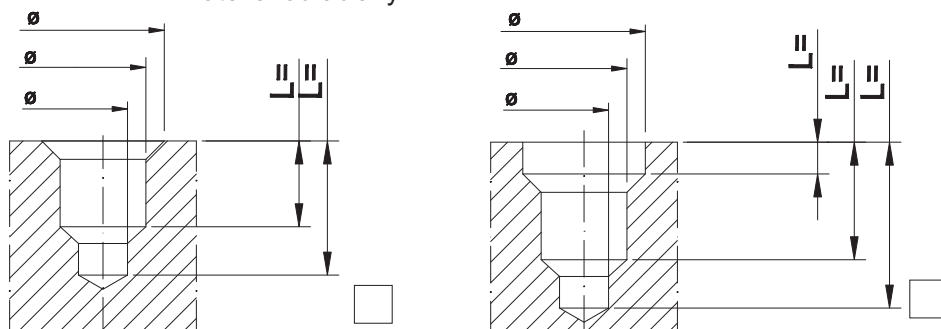

2. Narzędzie:

2.1. Nr. rysunku narzędzia:.....

2.2. Sugerowany materiał:

2.3. Sugerowana powłoka PVD:.....

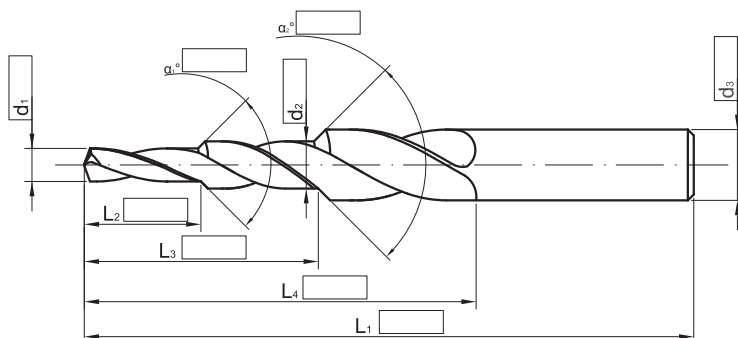

3. Wykonanie:

3.1. Rowki: prawoskrętne Lewoskrętne Proste Kąt lini śrubowej:

3.2. Kierunek Cięcia: Prawotnące Lewotnące

3.3. Chłodzenie: Zewnętrzne Wewnętrzne Bez chłodzenia

3.4. Chwył: DIN-6535-HA DIN-6535-HB DIN-65350HE

4. Maszyna:

4.1. Typ maszyny:

4.2. Typ/wielkość wrzeciona:

4.3. Moc maszyny[kW]:

4.4. Max prędkość obr[obr/min]:

5. Uwagi

.....

Cena sugerowana:

Wypełnij w wersji online



FORMULARZ DOBORU NARZĘDZIA



Wypełnia FANAR

Data wpłynięcia:..... Sprawę przyjął:..... Nr zapytania

Data:

WIERTŁO SPECJALNE

DANE KLIENTA

Nazwa i adres firmy:

Osoba kontaktowa:tel.....

1. Szkic obrabianej części

1.1. Nazwa detalu:..... 1.2. Materiał obrabiany:.....

1.3. Twardość:

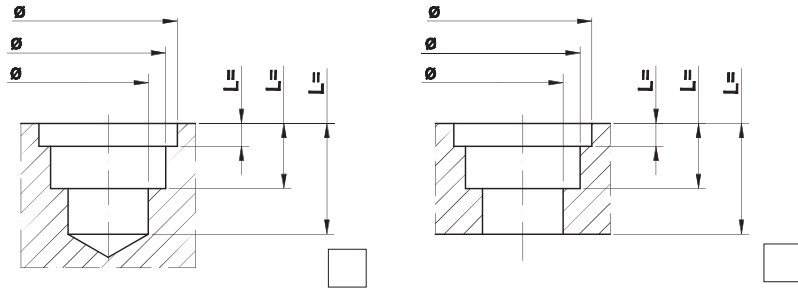

2. Narzędzie:

2.1. Nr. rysunku narzędzia:.....

2.2. Sugerowany materiał:

2.3. Sugerowana powłoka PVD:.....

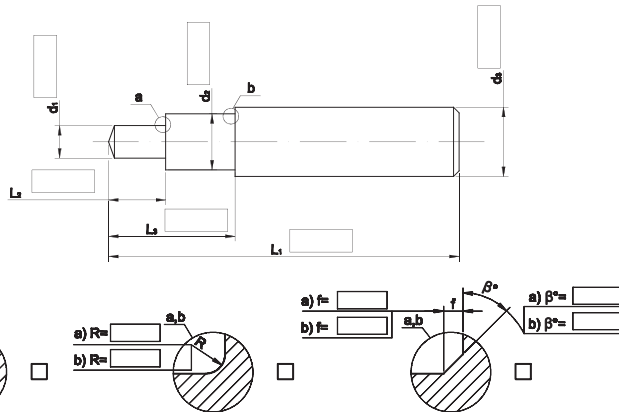

3. Wykonanie:

3.1. Rowki: Prawoskrętne Lewoskrętne Proste Kąt lini śrubowej:

3.2. Kierunek Cięcia: Prawotnące Lewotnące

3.3. Chłodzenie: Zewnętrzne Wewnętrzne Bez chłodzenia

3.4. Chwył: DIN-6535-HA DIN-6535-HB DIN-65350HE

4. Maszyna:

4.1. Typ maszyny:

4.2. Typ/wielkość wrzeciona:

4.3. Moc maszyny[kW]:

4.4. Max prędkość obr[obr/min]:

5. Uwagi

.....

Cena sugerowana:

Wypełnij w wersji online 